



Small-scale aquaponic food production

Integrated fish and plant farming



Cover photographs:

Top: Illustration of a media bed aquaponic system, clearly showing the connection of the fish tank and plant growing area. Bottom left to right: a mixed culture of tilapia (*Oreochromis niloticus*) and catfish (*Clarias fuscus*) in a aquaponic system (courtesy Irene Nurzia Humburg); farmer lifting the polystyrene raft to show the roots of curly kale (*Brassica oleracea*) growing within a deep water culture aquaponic system (courtesy Hilla Noam); and a farmer harvesting tomatoes (*Solanum lycopersicum*) from an aquaponic system on a rooftop (courtesy Christopher Somerville).

Small-scale aquaponic food production

Integrated fish and plant farming

FAO
FISHERIES AND
AQUACULTURE
TECHNICAL
PAPER

589

Christopher Somerville

FAO Consultant

Ireland

Moti Cohen

FAO Consultant

Israel

Edoardo Pantanella

FAO Consultant

Italy

Austin Stankus

FAO Consultant

Italy

and

Alessandro Lovatelli

FAO Aquaculture Branch

Italy

The designations employed and the presentation of material in this information product do not imply the expression of any opinion whatsoever on the part of the Food and Agriculture Organization of the United Nations (FAO) concerning the legal or development status of any country, territory, city or area or of its authorities, or concerning the delimitation of its frontiers or boundaries. The mention of specific companies or products of manufacturers, whether or not these have been patented, does not imply that these have been endorsed or recommended by FAO in preference to others of a similar nature that are not mentioned.

The views expressed in this information product are those of the author(s) and do not necessarily reflect the views or policies of FAO.

ISBN 978-92-5-108532-5 (print)
E-ISBN 978-92-5-108533-2 (PDF)

© FAO, 2014

FAO encourages the use, reproduction and dissemination of material in this information product. Except where otherwise indicated, material may be copied, downloaded and printed for private study, research and teaching purposes, or for use in non-commercial products or services, provided that appropriate acknowledgement of FAO as the source and copyright holder is given and that FAO's endorsement of users' views, products or services is not implied in any way.

All requests for translation and adaptation rights, and for resale and other commercial use rights should be made via www.fao.org/contact-us/licence-request or addressed to copyright@fao.org.

FAO information products are available on the FAO website (www.fao.org/publications) and can be purchased through publications-sales@fao.org.

Preparation of this document

This technical paper showcases current wisdom in aquaponics, focusing on small-scale production. The publication is divided into nine chapters and nine appendixes, with each chapter dedicated to a specific facet of an aquaponic system. The target audience is agriculture extension agents, aquaculture officers, non-governmental organizations, community organizers, companies and individuals – worldwide. The intention is to bring a general understanding of aquaponics to people who previously may have only known about one aspect, i.e. aquaculture agents without experience in hydroponics, and vice versa.

This publication does not provide a prescriptive approach to aquaponics; instead this is a resource paper and includes description and discussion of the major concepts needed for aquaponics. A broad range of parties may find interest in aquaponics, especially those whose programmatic focus incorporates at least one of the following topics: sustainable agriculture, resilient methods of domestic food production, or urban and peri-urban food security. Although not strictly necessary, some experience with vegetable and/or fish production would be advantageous for the reader. This publication is written in a style designed to be digestible by a non-technical reader. This technical paper includes diverse subjects from aquaculture to hydroponics, water chemistry to ecosystem balance and technical aspects of plumbing and construction; the challenge has been to provide a bridge towards common understanding of the broad field of aquaponics, using adequate technical details in substantial depth without allowing the publication to become unwieldy and unusable.

This publication is the product of practical experience with small-scale and commercial aquaponic systems, and was developed to share the lessons and current knowledge learned so that fledgling farmers can benefit from these experiences.

This publication was prepared in recognition of multiple FAO strategic objectives, major areas of work and regional initiatives; small-scale aquaponic systems reinforce interventions of the regional water scarcity initiative, and support the major area of work regarding sustainable intensification of agriculture through the efficient use of resources.

Abstract

This technical paper begins by introducing the concept of aquaponics, including a brief history of its development and its place within the larger category of soil-less culture and modern agriculture. It discusses the main theoretical concepts of aquaponics, including the nitrogen cycle and the nitrification process, the role of bacteria, and the concept of balancing an aquaponic unit. It then moves on to cover important considerations of water quality parameters, water testing, and water sourcing for aquaponics, as well as methods and theories of unit design, including the three main methods of aquaponic systems: media beds, nutrient film technique, and deep water culture.

The publication discusses in detail the three groups of living organisms (bacteria, plants and fish) that make up the aquaponic ecosystem. It also presents management strategies and troubleshooting practices, as well as related topics, specifically highlighting local and sustainable sources of aquaponic inputs.

The publication also includes nine appendixes that present other key topics: ideal conditions for common plants grown in aquaponics; chemical and biological controls of common pests and diseases including a compatible planting guide; common fish diseases and related symptoms, causes and remedies; tools to calculate the ammonia produced and biofiltration media required for a certain fish stocking density and amount of fish feed added; production of homemade fish feed; guidelines and considerations for establishing aquaponic units; a cost–benefit analysis of a small-scale, media bed aquaponic unit; a comprehensive guide to building small-scale versions of each of the three aquaponic methods; and a brief summary of this publication designed as a supplemental handout for outreach, extension and education.

Contents

Preparation of this document	iii
Abstract	iv
Acknowledgements	x
Authors	xi
Abbreviations and acronyms	xii
Figure credits	xiv
List of figures	xv
List of tables	xix
1. Introduction to aquaponics	1
1.1 Hydroponics and soil-less culture	1
1.2 Aquaculture	3
1.3 Aquaponics	4
1.4 Applicability of aquaponics	5
1.5 A brief history of modern aquaponic technology	7
1.6 Current applications of aquaponics	8
1.6.1 Domestic/small-scale aquaponics	8
1.6.2 Semi-commercial and commercial	8
1.6.3 Education	9
1.6.4 Humanitarian relief and food security interventions	9
2. Understanding aquaponics	11
2.1 Important biological components of aquaponics	11
2.1.1 The nitrogen cycle	11
2.2 The biofilter	13
2.3 Maintaining a healthy bacterial colony	14
2.3.1 Surface area	14
2.3.2 Water pH	14
2.3.3 Water temperature	14
2.3.4 Dissolved oxygen	15
2.3.5 Ultraviolet light	15
2.4 Balancing the aquaponic ecosystem	16
2.4.1 Nitrate balance	16
2.4.2 Feed rate ratio	17
2.4.3 Health check of fish and plants	18
2.4.4 Nitrogen testing	18
2.5 Chapter summary	19
3. Water quality in aquaponics	21
3.1 Working within the tolerance range for each organism	21
3.2 The five most important water quality parameters	22
3.2.1 Oxygen	22
3.2.2 pH	23
3.2.3 Temperature	24
3.2.4 Total nitrogen: ammonia, nitrite, nitrate	25
3.2.5 Water hardness	26

3.3	Other major components of water quality: algae and parasites	28
3.3.1	Photosynthetic activity of algae	28
3.3.2	Parasites, bacteria and other small organisms living in the water	29
3.4	Sources of aquaponic water	29
3.4.1	Rainwater	30
3.4.2	Cistern or aquifer water	30
3.4.3	Tap or municipal water	30
3.4.4	Filtered water	31
3.5	Manipulating pH	31
3.5.1	Lowering pH with acid	31
3.5.2	Increasing pH with buffers or bases	32
3.6	Water testing	32
3.7	Chapter summary	33
4.	Design of aquaponic units	35
4.1	Site selection	38
4.1.1	Stability	39
4.1.2	Exposure to wind, rain and snow	39
4.1.3	Exposure to sunlight and shade	39
4.1.4	Utilities, fences and ease of access	40
4.1.5	Special considerations: rooftop aquaponics	40
4.1.6	Greenhouses and shading net structures	41
4.2	Essential components of an aquaponic unit	42
4.2.1	Fish tank	42
4.2.2	Filtration – mechanical and biological	44
4.2.3	Hydroponic components – media beds, NFT, DWC	48
4.2.4	Water movement	49
4.2.5	Aeration	51
4.2.6	Sump tank	52
4.2.7	Plumbing materials	53
4.2.8	Water testing kits	54
4.3	The media bed technique	54
4.3.1	Water flow dynamics	54
4.3.2	Media bed construction	55
4.3.3	Choice of medium	56
4.3.4	Filtration	58
4.3.5	The three zones of media beds – characteristics and processes	59
4.3.6	Irrigating media beds	61
4.4	Nutrient film technique (NFT)	63
4.4.1	Water flow dynamics	64
4.4.2	Mechanical and biological filtration	64
4.4.3	Nutrient film technique grow pipes, construction and planting	65
4.5	Deep water culture technique	67
4.5.1	Water flow dynamics	68
4.5.2	Mechanical and biological filtration	69
4.5.3	DWC grow canals, construction and planting	69
4.5.4	Special case DWC: low fish density, no filters	71
4.6	Comparing aquaponic techniques	73
4.7	Chapter summary	73

5. Bacteria in aquaponics	75
5.1 Nitrifying bacteria and the biofilter	75
5.1.1 High surface area	76
5.1.2 Water pH	76
5.1.3 Water temperature	76
5.1.4 Dissolved oxygen	76
5.1.5 UV light	76
5.1.6 Monitoring bacterial activity	77
5.2 Heterotrophic bacteria and mineralization	77
5.3 Unwanted bacteria	78
5.3.1 Sulphate reducing bacteria	78
5.3.2 Denitrifying bacteria	78
5.3.3 Pathogenic bacteria	78
5.4 System cycling and starting a biofilter colony	79
5.4.1 Adding fish and plants during the cycling process	81
5.5 Chapter summary	81
6. Plants in aquaponics	83
6.1 Major differences between soil and soil-less crop production	83
6.1.1 Fertilizer	83
6.1.2 Water use	84
6.1.3 Utilization of non-arable land	84
6.1.4 Productivity and yield	84
6.1.5 Reduced workload	85
6.1.6 Sustainable monoculture	85
6.1.7 Increased complication and high initial investment	85
6.2 Basic plant biology	86
6.2.1 Basic plant anatomy and function	86
6.2.2 Photosynthesis	87
6.2.3 Nutrient requirements	87
6.2.4 Aquaponic sources of nutrients	90
6.3 Water quality for plants	90
6.3.1 pH	91
6.3.2 Dissolved oxygen	91
6.3.3 Temperature and season	91
6.3.4 Ammonia, nitrite and nitrate	92
6.4 Plant selection	92
6.5 Plant health, pest and disease control	93
6.5.1 Plant pests, integrated production and pest management	94
6.5.2 Plant diseases and integrated disease management	98
6.6 Plant design	101
6.7 Chapter summary	102
7. Fish in aquaponics	103
7.1 Fish anatomy, physiology and reproduction	103
7.1.1 Fish anatomy	103
7.1.2 Fish reproduction and life cycle	105
7.2 Fish feed and nutrition	106
7.2.1 Components and nutrition of fish feed	106
7.2.2 Pelletized fish feed	106
7.2.3 Feed conversion ratio for fish and feeding rate	107

7.3	Water quality for fish	108
7.3.1	Nitrogen	108
7.3.2	pH	108
7.3.3	Dissolved oxygen	108
7.3.4	Temperature	109
7.3.5	Light and darkness	109
7.4	Fish selection	110
7.4.1	Tilapia	110
7.4.2	Carp	111
7.4.3	Catfish	113
7.4.4	Trout	114
7.4.5	Largemouth bass	114
7.4.6	Prawns	115
7.5	Acclimatizing fish	116
7.6	Fish health and disease	117
7.6.1	Fish health and well-being	117
7.6.2	Stress	117
7.6.3	Fish disease	118
7.7	Product quality	121
7.8	Chapter summary	121
8.	Management and troubleshooting	123
8.1	Component calculations and ratios	123
8.1.1	Plant growing area, amount of fish feed and amount of fish	123
8.1.2	Water volume	125
8.1.3	Filtration requirements – biofilter and mechanical separator	125
8.1.4	Summary of component calculations	125
8.2	New aquaponic systems and initial management	126
8.2.1	Building and preparing the unit	126
8.2.2	System cycling and establishing the biofilter	127
8.3	Management practices for plants	127
8.3.1	Review of planting guidelines	127
8.3.2	Establishing a plant nursery	128
8.3.3	Transplanting seedlings	129
8.3.4	Harvesting plants	131
8.3.5	Managing plants in mature systems	132
8.3.6	Plants – summary	132
8.4	Management practices for fish	133
8.4.1	Fish feeding and growth rates	133
8.4.2	Harvesting and staggered stocking	134
8.4.3	Fish – summary	135
8.5	Routine management practices	135
8.5.1	Daily activities	136
8.5.2	Weekly activities	136
8.5.3	Monthly activities	136
8.6	Safety at work	136
8.6.1	Electrical safety	136
8.6.2	Food safety	137
8.6.3	General safety	137
8.6.4	Safety – summary	137
8.7	Troubleshooting	137
8.8	Chapter summary	139

9. Additional topics on aquaponics	141
9.1 Sustainable, local alternatives for aquaponic inputs	141
9.1.1 Organic plant fertilizers	141
9.1.2 Alternative fish feed	143
9.1.3 Seed collection	146
9.1.4 Rainwater harvesting	147
9.1.5 Alternative building techniques for aquaponic units	147
9.1.6 Alternative energy for aquaponic units	148
9.2 Securing water levels for a small-scale unit	149
9.2.1 Float switches	149
9.2.2 Overflow pipes	150
9.2.3 Standpipes	150
9.2.4 Animal fences	150
9.3 Integrating aquaponics with other gardens	150
9.3.1 Irrigation and fertilization	150
9.3.2 Irrigating wicking beds	151
9.4 Examples of small-scale aquaponic setups	152
9.4.1 Aquaponics for livelihood in Myanmar	152
9.4.2 Saline aquaponics	152
9.4.3 Bumina and Yumina	154
9.5 Chapter summary	155
Further reading	157
Glossary	163
Appendixes	167
Appendix 1 – Vegetable production guidelines for 12 common aquaponic plants	169
Appendix 2 – Plant pests and disease control	183
Appendix 3 – Fish pests and disease control	187
Appendix 4 – Calculating the amount of ammonia and biofilter media for an aquaponic unit	191
Appendix 5 – Making homemade fish feed	193
Appendix 6 – Key considerations before setting up an aquaponic system	199
Appendix 7 – Cost-benefit analysis for small-scale aquaponic units	205
Appendix 8 – Step-by-step guide to constructing small-scale aquaponic systems	209
Aquaponics quick-reference handout	249

Acknowledgements

The authors gratefully acknowledge the vital contributions of the individuals who provided support during the preparation process of this paper.

In particular, the authors wish to thank the following individuals who provided photographs, preliminary editing and other technical support: Abu Ahmed, Iyad Al Attar, Yosi Bronfman, Rotem Bruner, Barak Cohen, Baruch Dach, Tim Evans, Mendy Falk, Eitan Hasman, Amit Hasman, Adar Marmur, Ayelet Ben Natan, Yoav Nevo, Irene Nurzia Humburg, Noga Perri, Nadav Reich, Valerie Rousselin, Tomr Sagee, Muhammad Shattali, Keren Taguri, Paolo Usseglio, Idan Ben Yaakov, Erez Yeruham and Efrat Zemer-Bronfman.

The authors wish to further acknowledge the contributions of Yogev Azulai, Akwak Geremew, Tal Pereg and Guy Rubinstein on aquaculture-related topics (including the small-scale production of fish feed); and of Philip Jones, Michael Raviv, Nitzan Solan and Lorena Viladomat for their inputs related to hydroponic and aquaponic food production.

The authors would also like to thank the following experts for reviewing the initial drafts of the document and providing their inputs during the review process. From the Food and Agriculture Organization of the United Nations (FAO), Wilfried Baudoin and Allison Hodder from the Plant Production and Protection Division, Tony Jarrett from the Fisheries and Aquaculture Department, and James Ebeling from the United States of America.

The development of this publication has benefited from many farmers, scientists, industry professionals, business owners, and technicians who have kindly shared their skills and experience.

This publication has been realized with the initial financial support from the European Union through the Indian Ocean Commission SmartFish Programme, and regular programme funds of FAO.

Special thanks go to Hilla Noam for her efforts on the technical drawings included in this publication. Page layout was prepared by José Luis Castilla Civit.

Authors

Chris Somerville

Urban Agriculture Consultant
Dublin, Ireland

Has worked with international and non-governmental organizations implementing sustainable urban agriculture projects in Ethiopia, Jordan and Palestine focusing on small-scale aquaponics and hydroponics. His current projects focus on developing innovative and integrated food production systems in conjunction with FAO in The West Bank and Gaza Strip.

Moti Cohen

Aquaponics Specialist
Hofit, Israel

Owner/director of a private company that provides sustainable agriculture technologies and water treatment solutions at the household level, especially focusing on aquaponics. He has designed and installed numerous commercial aquaponic units, has taught and led workshops on aquaponic food production, and has provided technical support to international projects.

Edoardo Pantanella

Agroecologist and Aquaponics Research Scientist
Rome, Italy

Research scientist focusing on integrated farming systems, especially aquaponics. His work is focused on aquaculture development, including freshwater and saline aquaponics for sustainable food systems and livelihoods in rural and urban sectors, especially in arid and saline environments. His interests include commercial development of aquaponics for fish nurseries, sea-agriculture, and wastewater farming.

Austin Stankus

FAO Consultant
Rome, Italy

His studies and work experience are in integrated aquaculture and agriculture systems, specifically aquaponics and organic farming, urban forestry mapping and spatial planning using GIS, biocomposting using black soldier flies to recycle food waste as alternative animal feed, and incorporating sustainable agriculture within the education sector as project-based learning for young farmers.

Alessandro Lovatelli

FAO Aquaculture Officer
Rome, Italy

A marine biologist and aquaculturist with extensive experience in global aquaculture development working with FAO and other international organizations. His area of work focuses mainly on marine aquaculture development, transfer of farming technologies and resource management. He has been active in promoting farming technologies applicable for food production in areas poor in freshwater resources.

Abbreviations and acronyms

AC/DC	alternating current / direct current
AOB	ammonia-oxidizing bacteria
C:N	carbon and nitrogen ratio
CaO	calcium oxide
Ca(OH) ₂	calcium hydroxide
CaCO ₃	calcium carbonate
CO ₂	carbon dioxide
CO ₃ ²⁻	carbonate
CHIFT-PIST	constant height in fish tank – pump in sump tank
CP	crude protein
DE	digestible energy
DIY	do it yourself
DNA	deoxyribonucleic acid
DO	dissolved oxygen
DWC	deep water culture
EAA	essential amino acids
EC	electrical conductivity
EFA	essential fatty acids
FAO	Food and Agriculture Organization of the United Nations
FCR	feed conversion ratio
GAP	good agricultural practice
GH	general hardness
H ⁺	hydrogen ion
H ₂ CO ₃	carbonic acid
H ₂ S	hydrogen sulphide
H ₂ SO ₄	sulphuric acid
H ₃ PO ₄	phosphoric acid
HCl	hydrochloric acid
HCO ₃ ⁻	bicarbonate
HNO ₃	nitric acid
IBC	intermediate bulk container
IPPM	integrated production and pest management
K ₂ CO ₃	potassium carbonate
KH	carbonate hardness
KHCO ₃	potassium bicarbonate
KOH	potassium hydroxide
LDPE	low-density polyethylene
LECA	light expanded clay aggregate
NaCl	sodium chloride
N	nitrogen
N ₂	molecular nitrogen
NFE	nitrogen-free extract
NFT	nutrient film technique
NH ₃	ammonia
NH ₄ ⁺	ammonium
NHO ₃	nitric acid
NO ₂ ⁻	nitrite

NO ₃ ⁻	nitrate
NOB	nitrite-oxidizing bacteria
μS/cm	microSiemens per centimetre
pH	power of hydrogen
ppm	parts per million
ppt	parts per thousand
PVC	polyvinyl chloride
RAS	recirculating aquaculture system
RCD	residual-current device
SSA	specific surface area
TAN	total ammonia nitrogen
TDS	total dissolved solids
USD	US dollar
UV	ultraviolet

Figure credits

Figure number	Credits
1.1 - 1.3 - 1.4 - 1.5 - 2.1 - 2.2 - 2.3 - 2.4 - 2.5 - 2.6 - 2.7 - 2.8 - 2.9 - 2.10 - 2.11 - 2.12 - 2.13 - 2.14 - 3.1 - 3.2 - 3.3 - 3.4 - 3.5 - 3.6 - 3.7 - 3.10 - 3.11 - 3.12 - 3.13 - 3.14 - 4.9 - 4.13 - 4.29 - 4.41 - 4.44 - 4.45 - 4.49 - 4.53 - 4.54 - 4.55 - 4.56 - 4.57 - 4.58 - 4.59 - 4.63 - 4.71 - 4.73 - 5.1 - 5.2 - 5.3 - 5.4 - 5.6 - 6.3 - 6.4 - 6.6 - 7.1(b) - 7.2 - 7.3 - 7.4 - 7.5 - 8.2(a) - 8.3 - 8.9 - 9.15 - A1.6 - A1.17	Hilla Noam
1.2 - 1.7 - 1.8 - 1.9 - 3.9 - 4.1 - 4.2 - 4.6 - 4.10 - 4.24 - 4.25 - 4.26 - 4.27 - 4.28 - 4.33 - 4.38 - 4.46 - 4.47 - 4.50 - 4.60 - 4.62 - 4.66 - 4.67 - 4.68 - 4.69 - 4.72 - 4.74 - 4.76 - 6.5(d) - 6.8(c) - 6.10 - 6.11(b) - 7.13 - 8.7(b,c) - 9.1 - 9.8 - 9.11 - A1.5 - A1.13 - A1.22	Moti Cohen
1.6	Gilad Lugasy
1.10 - 3.8 - 4.5 - 4.17 - 4.18 - 4.22 - 4.31 - 4.35 - 4.36 - 4.37 - 4.52 - 5.5 - 5.7 - 6.1 - 6.2 - 6.7 - 6.8(b) - 6.9 - 6.11(a) - 6.13 - 8.1 - 8.2(b) - 8.4 - 9.12(a) - 9.16 - A1.1 - A1.2 - A1.3 - A1.4 - A1.7 - A1.8 - A1.9 - A1.11 - A1.12 - A1.14 - A1.15 - A1.16 - A1.18 - A1.20 - A1.21	Christopher Somerville
4.3 - 4.43 - 9.14	Austin Stankus
4.4 - 4.51 - 6.12	Mosh Kasirer
4.7	Yizhak Ben Israel
4.8	Yaniv Fieldust
4.11	Yehuda Feingold
4.12 - 4.75	Mendi Falck
4.14 - 4.70	Alon Zimerman
4.15 - 4.64 - 4.65 - 6.8(a) - 8.5 - 8.6 - 8.7(a) - 8.8 - 9.3 - 9.7	Idan Ben Yakov
4.16 - A1.10	Iugene Korn
4.19	Fahad Saleh Ibrahim
4.20	Yuval Aliba
4.21	Tal Munchas
4.23	Yugav Azulai
4.30 - 4.32	Ethan Hasman
4.34 - 4.48	Amit Hasman
4.39 - 9.2 - 9.5 - 9.6	Irene Nurzia Humburg
4.40	Guy Tabak
4.42	Paolo Usseglio
4.61	James Ebeling
6.5(a,b,c) - 9.4	Nitzan Solan
7.1(a)	Livingreen Systems
7.6 - 7.7(a) - 7.9(a) - 7.10(a) - 7.11(a) - 7.12	FAO
7.7(b)	Ming Junchao
7.8	Koi on Demand Ltd.
7.9(b)	Victor Pouomogne
7.10(b)	Produttori Ittici Trevigiani
7.11(b)	Marc Towers
7.14	Pierpaolo Patarnello
9.9	Yaniv Cohen
9.10	Karen Tagury
9.12(b) - 9.13	Itai Levi
9.17 - 9.18 - 9.19 - 9.20	Edoardo Pantanella
9.21	Slamet Widayadi
A1.19	Nir Kroshaniivski

List of figures

Figure No.		Page
1.	Introduction to aquaponics	1
1.1	Tilapia in an aquaponic fish tank	1
1.2	Plants grown using aquaponics	1
1.3	Simple hydroponic unit	2
1.4	Recirculating aquaculture system	3
1.5	Simple hydroponic unit	5
1.6	Domestic backyard aquaponic unit in an arid area	8
1.7	Medium sized commercial aquaponic system	8
1.8	Combined aquaponic unit for educational purposes. (a) nutrient film technique; (b) media bed; (c) deep water culture; (d) fish tank	9
1.9	Small-scale aquaponic unit	10
1.10	Rooftop small-scale aquaponic unit	10
2.	Understanding aquaponics	11
2.1	The biological components in the aquaponic process: fish, plants and bacteria	11
2.2	The nitrogen cycle (simplified)	12
2.3	Nitrogen flow chart in nature	12
2.4	Nitrogen flow chart in soil	13
2.5	Nitrogen flow chart in an aquaponic system	13
2.6	The nitrification process in an aquaponic system	14
2.7	Media bed aquaponic system with volcanic gravel provides a large surface area for bacterial growth	14
2.8	Digital pH and temperature meter	15
2.9	Aerated biofilter (a) containing plastic filter medium (b)	15
2.10	Fish biomass exceeding the biofilter carrying capacity and therefore an accumulation of toxic ammonia and nitrite occurs	16
2.11	Fish and biofilter are correctly sized, but the system is unbalanced with too few plants and therefore too much nitrate	16
2.12	Fish and biofilter are correctly sized, but the system is unbalanced with too many plants and therefore insufficient nitrate	17
2.13	A balanced system where fish, plants and bacteria are in dynamic equilibrium	17
2.14	Nitrate test kit	18
3.	Water quality in aquaponics	21
3.1	Essential water testing supplies	21
3.2	The aquaponic ecosystem	21
3.3	General dissolved oxygen tolerances for fish	23
3.4	Oxygen solubility in water at different temperatures	23
3.5	Visual representation of the pH scale	23
3.6	Hydrogen and carbonate ions bonding	27
3.7	Bicarbonate and nitric acid bonding in aquaponics	28
3.8	Algae growth in aquaponic system	29
3.9	Algae growing on plastic pipe	29
3.10	Checking the pH level in water using a digital meter	31
3.11	Phosphoric acid (H_3PO_4 – 85% concentration)	32
3.12	Adding seashells in a net bag to release carbonate into the aquaponic unit	31

3.13	Freshwater test kit for pH, ammonia, nitrite and nitrate. Values are determined by comparing the test water colour with that of the reference card	33
3.14	Colour-coded water quality test strips	33
4.	Design of aquaponic units	35
4.1	Illustration of a small media bed unit	35
4.2	Example of a newly assembled media bed unit using intermediate bulk containers	36
4.3	Taro (<i>Colocasia esculenta</i>) plants growing in a semi-commercial media bed unit constructed in wood and lined with polyethylene liner	36
4.4	Lush vegetable growth in a backyard media bed unit	36
4.5	A media bed unit planted with chili pepper (<i>Capsicum</i> spp.)	36
4.6	Illustration of a small nutrient film technique unit	37
4.7	Parsley (<i>Petroselinum</i> sp.) growing in a small nutrient film technique unit	37
4.8	Farmers tending young tomato plants in a nutrient film technique unit. Net cups are made from recycled plastic bottles with holes in the bottom	37
4.9	A nutrient film technique unit using vertical space	37
4.10	Illustration of a small deep water culture unit	38
4.11	Lettuce plants growing in a deep water culture unit	38
4.12	Multiple varieties of lettuce plants growing in a deep water culture unit	38
4.13	Roots of curly kale (<i>Brassica</i> sp.) growing in a deep water culture unit	38
4.14	Deep water culture system damaged by snow	39
4.15	Shade material (blue) filtering sunlight in the fish tank	40
4.16	A small media bed unit on a rooftop	40
4.17	Multiple aquaponic systems on a rooftop	41
4.18	Variety of vegetables growing on a rooftop in nutrient film technique systems	41
4.19	Small aquaponic units in a greenhouse	41
4.20	Newly assembled aquaponic units in a greenhouse	41
4.21	Net house structure to house a small aquaponic unit	42
4.22	A 1 000 litre fish tank made from a white polyethylene drum	43
4.23	Young fish in a cylindrical aquaponic tank. Return line (top) and bottom drain clearly visible	43
4.24	Two large (2 000 litre) rectangular fish tanks holding separate cohorts of juvenile fish	44
4.25	Diagram of a mechanical solids separator	45
4.26	Picture of a mechanical solids separator	45
4.27	Diagram of a mechanical solids separator with baffles	45
4.28	Diagram of a biofilter for small-scale nutrient film technique and deep water culture units	46
4.29	Detail of plastic biofilter medium with large specific surface area	46
4.30	Details of biofilter showing the (a) additional mechanical filtration and (b) the biofilter medium	46
4.31	Small-scale media bed unit using a screen for additional mechanical filtration	47
4.32	A media bed unit used for filtration in a deep water culture system	47
4.33	Diagram of a mechanical solids separator (right) connected to the biofilter (left)	48
4.34	Top view of mechanical solids separator (right) connected to the biofilter (left)	48
4.35	Vegetables growing in a media bed unit	48
4.36	Different vegetable plants growing in the same media bed	48
4.37	Detail of lettuce plants growing in circular pipes of a nutrient film technique unit	49
4.38	Lettuce growing in square pipes of a nutrient film technique unit	49
4.39	Swiss chard (<i>Beta</i> sp.) suspended on a polystyrene raft in a deep water culture canal	49
4.40	Lettuce growing densely in small deep water culture unit	49
4.41	Submersible water pump, commercially available in many brands, used in small-scale aquaponic units	50

4.42	Simple water airlift	50
4.43	Backyard aquaponic system without the use of a water pump	51
4.44	Small air pump commercially available in many brands	51
4.45	Air stone used to diffuse pressurized air into fine bubbles in the water	51
4.46	Step by step preparation of a Venturi siphon. A small section of pipe (a) is inserted into the end of the main water pipe (b). A small notch is cut (c, d) into the narrower pipe through which air is sucked (e)	52
4.47	Sump tank buried in the ground to allow water collection by gravity	53
4.48	A selection of commonly used plumbing materials	53
4.49	Water test kit, available in many brands, including tests for ammonia, nitrite, nitrate, pH and alkalinity	54
4.50	Illustration of a small media bed unit	55
4.51	Media bed unit constructed from intermediate bulk containers	55
4.52	Fibreglass tanks used in a media bed unit	56
4.53	Volcanic tuff used as growing medium	56
4.54	Limestone gravel used as growing medium	57
4.55	Light expanded clay aggregate pellets used as growing medium	57
4.56	The three zones of a media bed during the drain cycle	60
4.57	The three zones of a media bed during the flood cycle	60
4.58	Diagram of a bell siphon and components installed in a grow bed	61
4.59	Diagram of a media bed standpipe and media guard	62
4.60	Illustration of a small nutrient film technique unit	63
4.61	Lettuce growing in a commercial nutrient film technique unit	64
4.62	Lettuce growing in square grow pipes of a nutrient film technique unit	65
4.63	Grow pipes of a nutrient film technique unit arranged vertically	65
4.64	Several grow pipes showing hole spacing	66
4.65	Plant support materials showing grow medium and net cup	66
4.66	Full size lettuce harvested from a nutrient film technique unit. Net cup and PVC extender are clearly visible	67
4.67	Lettuce plant grown without a net cup directly in a grow pipe	67
4.68	Illustration of a small deep water culture unit using a media bed as filtration	67
4.69	Illustration of a small deep water culture unit using standalone filtration	68
4.70	A large deep water culture unit	68
4.71	A small-scale deep water culture aquaponic unit. Plant roots visible below the polystyrene raft	69
4.72	Air stone used inside a deep water culture canal	69
4.73	An illustration of the Kratky method for deep water culture showing the separation between the raft and the water surface	70
4.74	Polystyrene sheet in a small deep water culture unit showing planting holes	70
4.75	Step by step procedure of placing a seedling and gravel (a) into a net cup (b) and placing it into the polystyrene raft in the deep water culture unit (c)	70
4.76	Illustration of a small deep water culture without a mechanical solid separator or biofilter	71
5.	Bacteria in aquaponics	75
5.1	The nitrification process in aquaponics	75
5.2	Structures of a heterotrophic bacterium	77
5.3	Levels of ammonia, nitrite and nitrate during the first few weeks in a recirculating aquaculture system	79
5.4	Fish food as a source of ammonia	80
5.5	Chicken manure as a source of ammonia	80
5.6	Test kit showing low ammonia level (0–0.5 mg/litre) (a) and high ammonia level (4 mg/litre) (b)	81
5.7	Adding a plant seedling into a media bed during the cycling process	81

6. Plants in aquaponics	83
6.1 Tomatoes (<i>Solanum</i> sp.) growing in soil	83
6.2 Swiss chard (<i>Beta</i> sp.) growing in an aquaponic system	83
6.3 Illustration of the basic plant structures	86
6.4 The photosynthesis process	87
6.5 Nitrogen deficiency visible in the pale older leaves (a); potassium deficiency visible as brown spots on the leaf margin (b); sulphur deficiency visible in the curled leaves and yellowing (c); and iron deficiency visible in the overall pale green colour of the mint plant (d)	90
6.6 The impact of pH on nutrient availability for plants	91
6.7 High nutrient demand vegetables growing in media beds, including eggplants (<i>Solanum</i> sp.) (a) and tomatoes (<i>Solanum</i> sp.) and cauliflower (<i>Brassica</i> sp.) (b)	93
6.8 Common diseases of plants include mildew caused by a fungus (a); canker/blight caused by bacteria (b); and leaf spots caused by bacteria or fungus (c)	93
6.9 Aquaponic units on a rooftop are isolated from some ground pests	95
6.10 Manual removal of insect pests	95
6.11 Yellow sticky trap (a) installed in a greenhouse (b)	96
6.12 Example of two media beds growing multiple types of vegetables	101
6.13 Examples of maximizing space in media beds using vining crops (a) and staggered planting (b)	102
7. Fish in aquaponics	103
7.1 Tilapia juveniles (a) and adults (b) growing in an aquaponic unit	103
7.2 Illustration of the main external anatomical features of fish	104
7.3 General life cycle of a fish	105
7.4 Example of fish feed in pellets and powder used for various size classes of fish	107
7.5 Weighing a sample of fish using a weighing scale	108
7.6 Line drawing and photograph of a Nile tilapia (<i>Oreochromis niloticus</i>)	110
7.7 Line drawing and photograph of a grass carp (<i>Ctenopharyngodon idella</i>)	112
7.8 Ornamental fish (<i>Cyprinus carpio</i>) in aquaponic system	112
7.9 Line drawing and photograph of an African catfish (<i>Clarias gariepinus</i>)	113
7.10 Line drawing and photograph of a Rainbow trout (<i>Oncorhynchus mykiss</i>)	114
7.11 Line drawing and photograph of a largemouth bass (<i>Micropterus salmoides</i>)	115
7.12 Line drawing and photograph of a giant river prawn (<i>Macrobrachium rosenbergii</i>)	115
7.13 Acclimatizing fish. Juvenile fish are transported in a plastic bag (a) which is floated in the receiving tank (b) and the fish are released (c)	116
7.14 Diseased fish showing several clinical symptoms: (a) gill damage (b) severe gill necrosis	118
8. Management and troubleshooting	123
8.1 Densely planted lettuce heads in a media bed unit (1 m ²)	124
8.2 Examples of a plant nursery (a) and lettuce seedlings (b)	128
8.3 Using an empty egg tray as a germination tray	129
8.4 Direct seeding into a media bed using cotton wool to retain moisture	129
8.5 Lettuce seedling with soil removed from roots prior to transfer into an aquaponic unit	130
8.6 Step-by-step procedure of transferring a seedling into a media bed unit. Removing the seedling from the nursery tray (a); digging a small hole in the medium (b); planting the seedling (c); and backfilling with medium (d)	130
8.7 Preparing the seedling, growing medium, net cup and extender for an nutrient film technique unit (a); placing the seedling and medium into the net cup (b); and inserting the net cup into the grow tube (c)	131

8.8	Preparing the seedling, growing medium, and net cup for a deep water culture unit (a); placing the seedling and medium into the net cup (b); and inserting the net cup into the floating raft (c)	131
8.9	During harvest the entire plant (including roots) is removed	132
9.	Additional topics on aquaponics	123
9.1	Upright compost unit	142
9.2	Redworms (<i>Eisenia fetida</i>) from a vermicompost unit	142
9.3	Brewing compost tea (placed in the net) in a bucket using an air pump	143
9.4	Duckweed growing in a container as fish feed supplement	144
9.5	<i>Azolla</i> spp. growing in a container as fish feed supplement	144
9.6	Black soldier fly (<i>Hermetia illucens</i>) adult (a) and larvae (b)	145
9.7	Seed collection from a dry basil plant (<i>Ocimum</i> spp.)	146
9.8	Rainwater collection from a roof	147
9.9	A bathtub recycled as a media bed	148
9.10	Photovoltaic cells used to power a water pump	148
9.11	Water heating technique using black tube arranged in a spiral	149
9.12	Float switch controlling a water pump (a) and a ballcock and float valve controlling the water main (b)	149
9.13	Overflow pipe on a biofilter	150
9.14	Stand pipe in a deep water culture canal maintaining the water column height	150
9.15	Illustration of a wicking bed system	151
9.16	An example of a wicking bed using a plastic container	151
9.17	A bamboo frame is filled with soil (a), excavated and then lined with polyethylene to create a grow canal and a media bed (b)	152
9.18	<i>Salsola</i> spp. growing in saline water two-thirds of sea strength <i>Salsola</i> produces 2–5 kg/m ² every month	153
9.19	Seabeet growing on a polystyrene sheet in a deep water culture unit at one-third of marine strength	153
9.20	Grafted tomato growing on sand at one-tenth of marine strength	153
9.21	Bumina systems in Indonesia with central concrete fish tanks (a,b) surrounded by satellite media beds culturing strawberry (c) and tomato plants (d)	154

List of tables

Table No.		Page
2.1	Water quality tolerance ranges for nitrifying bacteria	16
3.1	General water quality tolerances for fish (warm- or cold-water), hydroponic plants and nitrifying bacteria	22
3.2	Ideal parameters for aquaponics as a compromise between all three organisms	22
4.1	Characteristics of different growing media	58
4.2	Strengths and weaknesses of main aquaponic techniques	73
6.1	Summary table comparing soil-based and soil-less plant production	85
6.2	Effect of nutrients on fungal disease prevention	100
7.1	Water quality parameters, feed requirement and expected growth rates for seven commercial aquatic species commonly used in aquaponics	109
7.2	Causes and symptoms of stress in fish	117
8.1	Practical system design guide for small-scale aquaponic units	126
8.2	Potential growth rates of tilapia in one tank over a year using the staggered stocking method	134
8.3	Potential growth rates of tilapia in one tank over a year using a progressive harvest technique	135
8.4	Troubleshooting for common problems in aquaponic systems	138

1. Introduction to aquaponics

This chapter provides a full description of the concept of aquaponics, a technique for combining hydroponics and aquaculture in a system that cultivates plants in recirculated aquaculture water (Figures 1.1 and 1.2). It provides brief accounts of the development and nature of soil-less culture and general aquaculture. Aquaponics is then described, noting how these techniques are united, including additional considerations and a brief history of its development. An account of the major strengths and weaknesses of aquaponic food production is provided, as well as the places and contexts where aquaponics is most, and least, appropriate. Finally, there is a short description of the major applications of aquaponics seen today.

1.1 HYDROPONICS AND SOIL-LESS CULTURE

Soil-less culture is the method of growing agricultural crops without the use of soil. Instead of soil, various inert growing media, also called substrates, are used. These media provide plant support and moisture retention. Irrigation systems are integrated within these media, thereby introducing a nutrient solution to the plants' root zones. This solution provides all of the necessary nutrients for plant growth. The most common method of soil-less culture is hydroponics, which includes growing plants either on a substrate or in an aqueous medium with bare roots. There are many designs of hydroponic systems, each serving a different purpose, but all systems share these basic characteristics (Figure 1.3).

Soil-less agriculture has been used to reduce pests and soil-borne diseases affecting monoculture crops. Hydroponics can in fact control soil-borne pests and diseases by avoiding the contact between plants and soil, and because soil-less media can be sterilized and reused between crops. This reuse of substrates meets the particular demands of intensive production. Some substrates are far better than soil, particularly in terms of water-holding capacity and oxygen supply at the root zone. Farmers have also improved plant performance through increased control over several crucial factors of plant growth. Nutrient availability at plant roots is better manipulated, monitored and real-time controlled, leading to higher quantitative and qualitative productions. Moreover, most soil-less culture methods use a fraction of the water necessary for traditional soil-based production because the nutrient solution is recycled.

Soil-less agriculture is one aspect of the major scientific, economic and technological developments in the general field of agriculture over the last 200 years. In general, but

FIGURE 1.1
Tilapia in an aquaponic fish tank



FIGURE 1.2
Plants grown using aquaponics



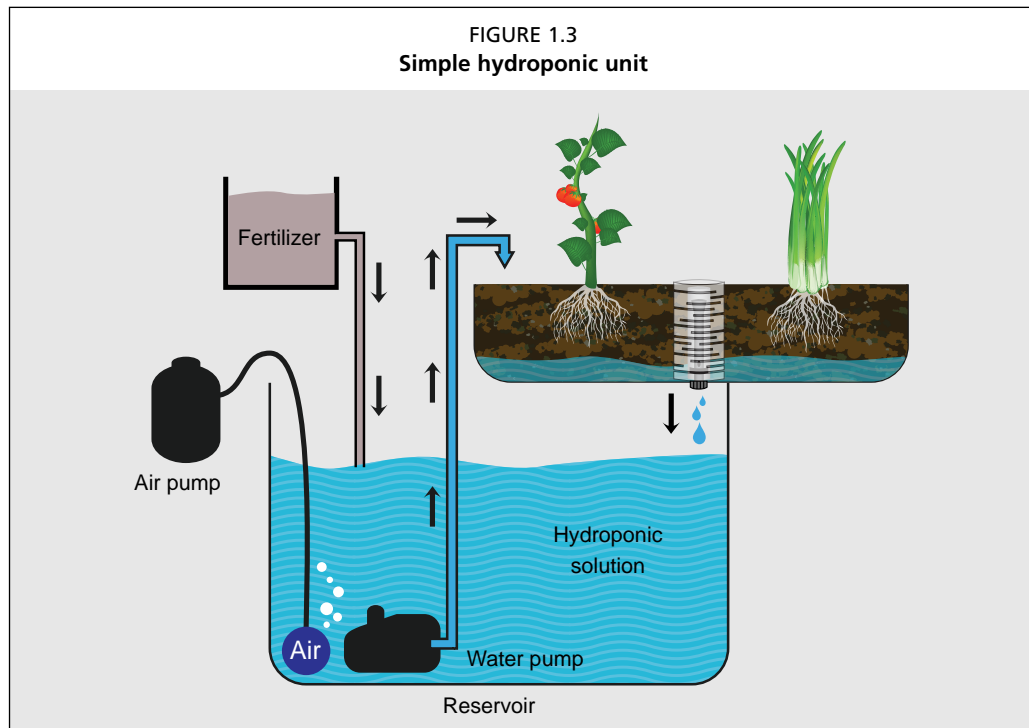

predominately in developed nations in temperate climates, there has been an increasing demand for out-of-season, high-value crops. Partly, this is a result of widespread improvements in living standards. This increase in demand has led to the expansion of many types of protected cultivation systems to boost production capacity and prolong the supply of crops throughout the year. Within these protected systems, crops can be grown in soil. However, in order to stay competitive with open-field agriculture production, intensity has had to increase in order to offset the higher production costs associated with controlled environment agriculture. As a result, there has been a shift from soil production to soil-less culture to address the changing needs of agriculture. This approach provides alternatives to toxic soil sterilization to control pests and pathogens, and can help to overcome the soil-tiredness problems that monoculture practices have brought.

Beyond its significantly higher yields compared with traditional agriculture, soil-less agriculture is also important because of its higher water- and fertilizer-use efficiency, which makes hydroponics the most suitable farming technique in arid regions or wherever nutrient dispersal is an issue for both environmental and economic reasons. The offset of soil makes hydroponics an indispensable solution in areas where arable land is not available. Soil-less agriculture can instead be developed in arid lands, in saline-prone areas, as well as in urban and suburban environments or wherever the competition for land and water or unfavourable climatic conditions require the adoption of intensive production systems. The high productivity for the small space required makes soil-less agriculture an interesting method for food security or for the development of micro-scale farming with zero food miles.

To summarize, the four main reasons why soil-less culture is an expanding agricultural practice are: decreased presence of soil-borne diseases and pathogens because of sterile conditions; improved growing conditions that can be manipulated to meet optimal plant requirements leading to increased yields; increased water- and fertilizer-use efficiency; and the possibility to develop agriculture where suitable land is not available. In addition with the rising in demand for chemical- and pesticide-free produce and more sustainable agricultural practices, there has been extensive research into organic and soil-less methods. Section 6.1 discusses these differences in more detail.

A major concern regarding the sustainability of modern agriculture is the complete reliance on manufactured, chemical fertilizers to produce food. These nutrients can be expensive and hard to source, and often come from environmentally harsh practices accounting for a substantial contribution of all carbon dioxide (CO₂) emissions from agriculture. The supply of many of these crucial nutrients is being depleted at a rapid pace, with projections of global shortages within the next few decades. Hydroponics is much more efficient in terms of water and nutrient use than is soil-based agriculture, but its management is more complicated and requires a different set of inputs, especially during installation. Electricity is generally required to circulate or oxygenate the water. However, it does not require fuel to plough soil, it does not require additional energy to pump much higher volumes of water for irrigation or to carry out weeding control, and it does not disrupt soil organic matter through intensive agricultural practices. The initial costs, building materials, and reliance on electricity and inputs will also be important limitations to aquaponics, but in this case the need for chemical fertilizers is completely removed.

1.2 AQUACULTURE

Aquaculture is the captive rearing and production of fish and other aquatic animal and plant species under controlled conditions. Many aquatic species have been cultured, especially fish, crustaceans and molluscs and aquatic plants and algae. Aquaculture production methods have been developed in various regions of the world, and have thus been adapted to the specific environmental and climatic conditions in those regions. The four major categories of aquaculture include open water systems (e.g. cages, long-lines), pond culture, flow-through raceways and recirculating aquaculture systems (RAS). In a RAS (Figure 1.4) operation water is reused for the fish after a cleaning and a filtering process. Although a RAS is not the cheapest production system owing to its higher investment, energy and management costs, it can considerably increase productivity per unit of land and is the most efficient water-saving technology in fish farming. A RAS is the most applicable method for the development of integrated aquaculture agriculture systems because of the possible use of by-products and the higher water nutrient concentrations for vegetable crop production. Aquaponics

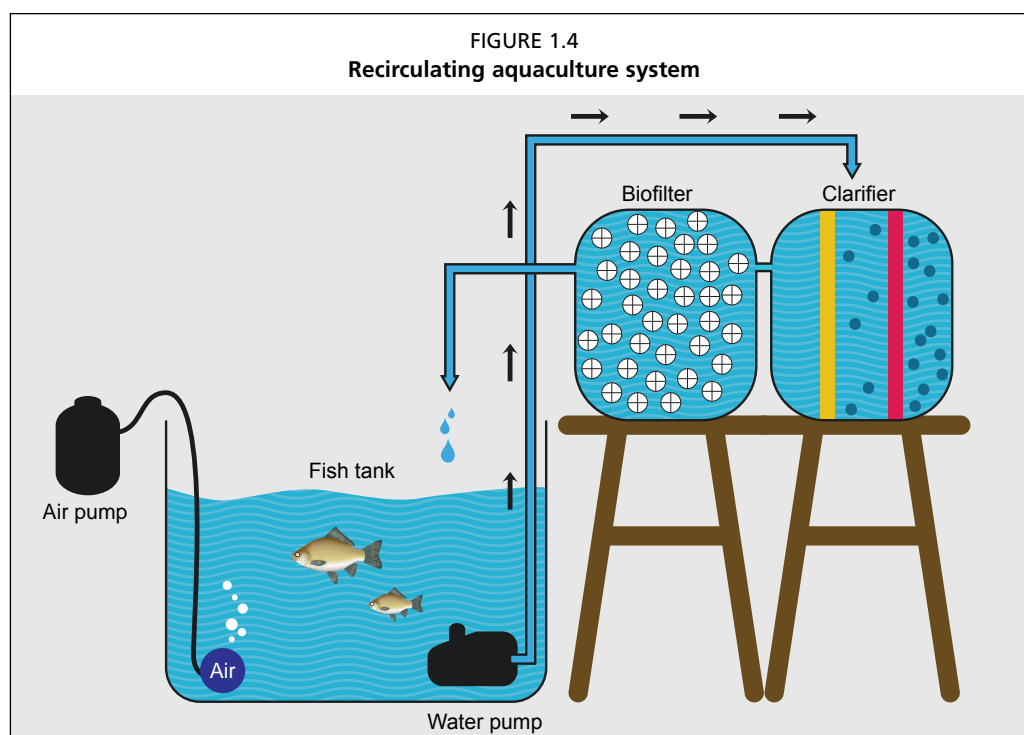

has been developed from the beneficial buildup of nutrients occurring in RASs and, therefore, is the prime focus of this manual.

Aquaculture is an increasingly important source of global protein production. In fact, aquaculture accounts for almost one-half of the fish eaten in the world, with aquaculture production matching capture fisheries landings for the first time in 2012. Aquaculture has the potential to decrease the pressure on the world's fisheries and to significantly reduce the footprint of less-sustainable terrestrial animal farming systems in supplying humans with animal protein. However, two aspects of aquaculture may be addressed to improve the sustainability of this agricultural technique. One major problem for the sustainability of aquaculture is the treatment of nutrient-rich wastewater, which is a by-product of all the aquaculture methods mentioned above. Depending on the environmental regulations set by each country, farmers must either treat or dispose of the effluent, which can be both expensive and environmentally harmful. Without treatment, the release of nutrient-rich water can lead to eutrophication and hypoxia in the watershed and localized coastal areas, as well as macroalgae overgrowth of coral reefs and other ecological and economical disturbances. Growing plants within the effluent stream is one method of preventing its release into the environment and of obtaining additional economic benefits from crops growing with costless by-products through irrigation, artificial wetlands, and other techniques. Another sustainability concern is that aquaculture relies heavily on fishmeal as the primary fish feed. From a conservation standpoint, this is discharging one debt by incurring another, and alternative feed ingredients are an important consideration for the future of aquaculture. The majority of this publication is dedicated to reusing aquaculture effluent as a value-added product, while alternative fish feeds and their ways to contribute to reducing the aquaculture footprint are discussed in Section 9.1.2.

1.3 AQUAPONICS

Aquaponics is the integration of recirculating aquaculture and hydroponics in one production system. In an aquaponic unit, water from the fish tank cycles through filters, plant grow beds and then back to the fish (Figure 1.5). In the filters, the fish wastes is removed from the water, first using a mechanical filter that removes the solid waste and then through a biofilter that processes the dissolved wastes. The biofilter provides a location for bacteria to convert ammonia, which is toxic for fish, into nitrate, a more accessible nutrient for plants. This process is called nitrification. As the water (containing nitrate and other nutrients) travels through plant grow beds the plants uptake these nutrients, and finally the water returns to the fish tank purified. This process allows the fish, plants, and bacteria to thrive symbiotically and to work together to create a healthy growing environment for each other, provided that the system is properly balanced.

In aquaponics, the aquaculture effluent is diverted through plant beds and not released to the environment, while at the same time the nutrients for the plants are supplied from a sustainable, cost-effective and non-chemical source. This integration removes some of the unsustainable factors of running aquaculture and hydroponic systems independently. Beyond the benefits derived by this integration, aquaponics has shown that its plant and fish productions are comparable with hydroponics and recirculating aquaculture systems. Aquaponics can be more productive and economically feasible in certain situations, especially where land and water are limited. However, aquaponics is complicated and requires substantial start-up costs. The increased production must compensate for the higher investment costs needed to integrate the two systems. Before committing to a large or expensive system, a full business plan considering economic, environmental, social and logistical aspects should be conducted.

Although the production of fish and vegetables is the most visible output of aquaponic units, it is essential to understand that aquaponics is the management of a complete ecosystem that includes three major groups of organisms: fish, plants and bacteria.

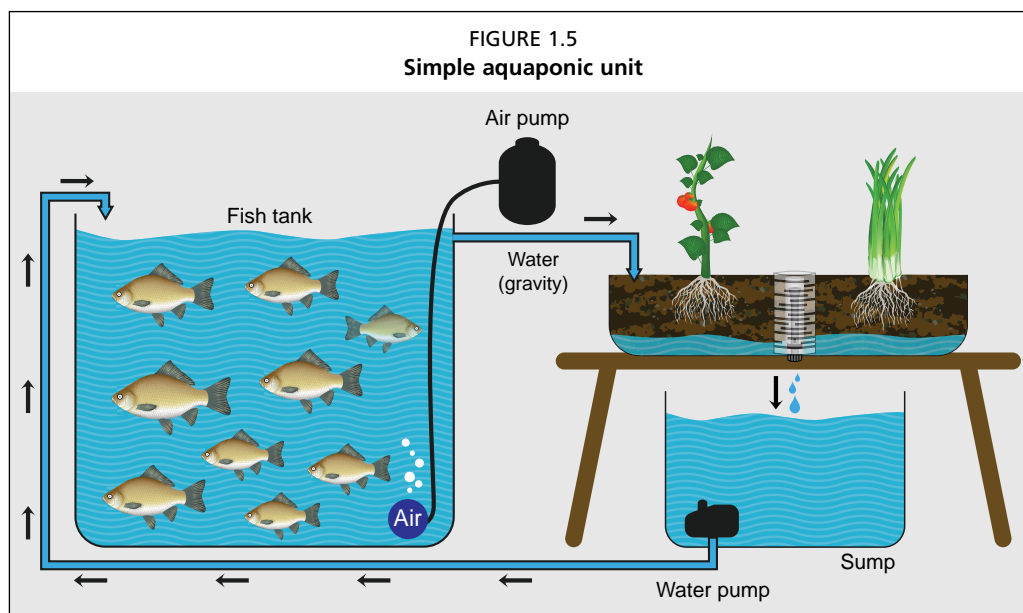

1.4 APPLICABILITY OF AQUAPONICS

Aquaponics combines two of the most productive systems in their respective fields. Recirculating aquaculture systems and hydroponics have experienced widespread expansion in the world not only for their higher yields, but also for their better use of land and water, simpler methods of pollution control, improved management of productive factors, their higher quality of products and greater food safety (Box 1). However, aquaponics can be overly complicated and expensive, and requires consistent access to some inputs.

BOX 1

Benefits and weaknesses of aquaponic food production

Major benefits of aquaponic food production:

- Sustainable and intensive food production system.
- Two agricultural products (fish and vegetables) are produced from one nitrogen source (fish food).
- Extremely water-efficient.
- Does not require soil.
- Does not use fertilizers or chemical pesticides.
- Higher yields and qualitative production.
- Organic-like management and production.
- Higher level of biosecurity and lower risks from outer contaminants.
- Higher control on production leading to lower losses.
- Can be used on non-arable land such as deserts, degraded soil or salty, sandy islands.
- Creates little waste.
- Daily tasks, harvesting and planting are labour-saving and therefore can include all genders and ages.
- Economical production of either family food production or cash crops in many locations.
- Construction materials and information base are widely available.

Continue next page

Continued from previous page

Major weaknesses of aquaponic food production:

- Expensive initial start-up costs compared with soil vegetable production or hydroponics.
- Knowledge of fish, bacteria and plant production is needed for each farmer to be successful.
- Fish and plant requirements do not always match perfectly.
- Not recommended in places where cultured fish and plants cannot meet their optimal temperature ranges.
- Reduced management choices compared with stand-alone aquaculture or hydroponic systems.
- Mistakes or accidents can cause catastrophic collapse of system.
- Daily management is mandatory.
- Energy demanding.
- Requires reliable access to electricity, fish seed and plant seeds.
- Alone, aquaponics will not provide a complete diet.

Aquaponics is a technique that has its place within the wider context of sustainable intensive agriculture, especially in family-scale applications. It offers supportive and collaborative methods of vegetable and fish production and can grow substantial amounts of food in locations and situations where soil-based agriculture is difficult or impossible. The sustainability of aquaponics considers the environmental, economic and social dynamics. Economically, these systems require substantial initial investment, but are then followed by low recurring costs and combined returns from both fish and vegetables. Environmentally, aquaponics prevents aquaculture effluent from escaping and polluting the watershed. At the same time, aquaponics enables greater water and production control. Aquaponics does not rely on chemicals for fertilizer, or control of pests or weeds which makes food safer against potential residues. Socially, aquaponics can offer quality-of-life improvements because the food is grown locally and culturally appropriate crops can be grown. At the same time, aquaponics can integrate livelihood strategies to secure food and small incomes for landless and poor households. Domestic production of food, access to markets and the acquisition of skills are invaluable tools for securing the empowerment and emancipation of women in developing countries, and aquaponics can provide the foundation for fair and sustainable socio-economic growth. Fish protein is a valuable addition to the dietary needs of many people, as protein is often lacking in small-scale gardening.

Aquaponics is most appropriate where land is expensive, water is scarce, and soil is poor. Deserts and arid areas, sandy islands and urban gardens are the locations most appropriate for aquaponics because it uses an absolute minimum of water. There is no need for soil, and aquaponics avoids the issues associated with soil compaction, salinization, pollution, disease and tiredness. Similarly, aquaponics can be used in urban and peri-urban environments where no or very little land is available, providing a means to grow dense crops on small balconies, patios, indoors or on rooftops.

However, this technique can be complicated and small-scale units will never provide all of the food for a family. Aquaponic systems are expensive; the owner must install a full aquaculture system and a hydroponic system, and this is the single most important element to consider when starting an aquaponic system. Moreover, successful management requires holistic knowledge and daily maintenance of the three separate groups of organisms involved. Water quality needs to be measured and manipulated. Technical skills are required to build and install the systems, especially in the case of plumbing and wiring. Aquaponics may be impractical and unnecessary in locations

with land access, fertile soil, adequate space and available water. Strong agricultural communities may find aquaponics to be overly complicated when the same food could be grown directly in the soil. In these cases, aquaponics can become an expensive hobby rather than a dedicated food production system. Moreover, aquaponics requires consistent access to some inputs. Electricity is required for all of the aquaponic systems described in this publication, and unreliable electricity grids and/or a high cost of electricity can make aquaponics unfeasible in some locations. Fish feed needs to be purchased on a regular basis, and there needs to be access to fish seed and plant seed. These inputs can be reduced (solar panels, fish feed production, fish breeding and plant propagation), but these tasks require additional knowledge and add time to the daily management, and they may be too onerous and time consuming for a small-scale system.

That said, the basic aquaponic system works in a wide range of conditions, and units can be designed and scaled to meet the skill and interest level of many farmers. There is a wide variety of aquaponic designs, ranging from high-tech to low-tech, and from high to reasonable price levels. Aquaponics is quite adaptable can be developed with local materials and domestic knowledge, and to suit local cultural and environmental conditions. It will always require a dedicated and interested person, or group of persons, to maintain and manage the system on a daily basis. Substantial training information is available through books, articles and online communities, as well as through training courses, agricultural extension agents and expert consultation. Aquaponics is a combined system, which means that both the costs and the benefits are magnified. Success is derived from the local, sustainable and intensive production of both fish and plants and, possibly, these could be higher than the two components taken separately, so long as aquaponics is used in appropriate locations while considering its limitations.

1.5 A BRIEF HISTORY OF MODERN AQUAPONIC TECHNOLOGY

The concept of using faecal waste and overall excrements from fish to fertilize plants has existed for millennia, with early civilizations in both Asia and South America applying this method. Through the pioneering work of the New Alchemy Institute and other North American and European academic institutions in the late 1970s, and further research in the following decades, this basic form of aquaponics evolved into the modern food production systems of today. Prior to the technological advances of the 1980s, most attempts to integrate hydroponics and aquaculture had limited success. The 1980s and 1990s saw advances in system design, biofiltration and the identification of the optimal fish-to-plant ratios that led to the creation of closed systems that allow for the recycling of water and nutrient buildup for plant growth. In its early aquaponic systems, North Carolina State University (United States of America) demonstrated that water consumption in integrated systems was just 5 percent of that used in pond culture for growing tilapia. This development, among other key initiatives, pointed to the suitability of integrated aquaculture and hydroponic systems for raising fish and growing vegetables, particularly in arid and water poor regions.

Although in use since the 1980s, aquaponics is still a relatively new method of food production with only a small number of research and practitioner hubs worldwide with comprehensive aquaponic experience. James Rakocy has been an industry leader regarding research and development through his work at the University of the Virgin Islands (United States of America). He has developed vital ratios and calculations in order to maximize production of both fish and vegetables while maintaining a balanced ecosystem. In Australia, Wilson Lennard has also produced key calculations and production plans for other types of systems. In Alberta, Canada, research by Nick Savidov over a two-year period produced results showing that aquaponics units had significantly superior production of tomatoes and cucumbers when some key nutrients levels were met. Mohammad Abdus Salam of the Bangladesh Agricultural University

furthered the field in home-scale subsistence farming with aquaponics. These research breakthroughs, as well as many others, have paved the way for various practitioner groups and support/training companies that are beginning to sprout worldwide. Suggested readings of the keystone works in aquaponics are provided at the end of this publication.

1.6 CURRENT APPLICATIONS OF AQUAPONICS

This final section briefly discusses some of the major applications of aquaponics seen around the world. This list is by no means exhaustive, but rather a small window into activities that are using the aquaponic concept. Appendix 6 includes further explanation as to where and in what contexts aquaponics is most applicable.

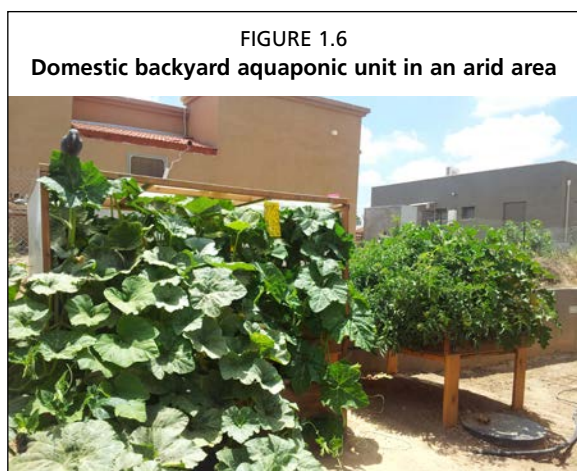

1.6.1 Domestic/small-scale aquaponics

Aquaponic units with a fish tank size of about 1 000 litres and growing space of about 3 m² are considered small-scale, and are appropriate for domestic production for a family household (Figure 1.6). Units of this size have been trialled and tested with great success in many regions around the world. The main purpose of these units is food production for subsistence and domestic use, as many units can have various types of vegetables and herbs growing at once. In the past five years, aquaponic groups, societies and forums have developed considerably and served to disseminate advice and lessons learned on these small-scale units.

1.6.2 Semi-commercial and commercial aquaponics

Owing to the high initial start-up cost and limited comprehensive experience with this scale, commercial and/or semi-commercial aquaponic systems are few in number (Figure 1.7). Many commercial ventures have failed because the profits could not meet the demands of the initial investment plan. Most of those that do exist use monoculture practices, typically the production of lettuce or basil. Although many academic institutes in the United States of America, Europe and Asia have constructed large units, most have been for academic research rather than food production, and are not intended or designed to compete with other producers in the private sector. There are several successful farms throughout the world. One group of experts

in Hawaii (United States of America) has created a fully-fledged commercial system. They have also been able to obtain organic certification for their unit, enabling them to reap a higher financial return for their output. Another large-scale and commercially successful aquaponic operation is located in Newburgh, New York (United States of America), and reaps profits through multiple revenue streams from diverse fish and vegetable species and a successful marketing strategy to local restaurants, grocery, and health food and farmers markets.

Detailed business plans with thorough market research on the most lucrative plants and fish in local and regional markets are essential for any successful venture, as is experience with small-scale aquaponics, commercial aquaculture and commercial hydroponics.

1.6.3 Education

Small-scale aquaponic units are being championed in various educational institutes including, primary and secondary schools, colleges and universities, special and adult education centres, as well as community-based organizations (Figure 1.8). Aquaponics is being used as a vehicle to bridge the gap between the general population and sustainable agricultural techniques, including congruent sustainable activities such as rainwater harvesting, nutrient recycling and organic food production, which can be integrated within the lesson plans. Moreover, this integrated nature of aquaponics provides hands-on learning experience of wide-ranging topics such as anatomy and physiology, biology and botany, physics and chemistry, as well as ethics, cooking, and general sustainability studies.



1.6.4 Humanitarian relief and food security interventions

With the advent of highly efficient aquaponic systems, there has been an interest in discovering how the concept fares in developing countries. Examples of aquaponic initiatives can be seen in Barbados, Brazil, Botswana, Ethiopia, Ghana, Guatemala, Haiti, India, Jamaica, Malaysia, Mexico, Nigeria, Panama, the Philippines, Thailand and Zimbabwe (Figure 1.9). At first glance, there appears to be a considerable amount of aquaponic activity within the humanitarian sphere. In addition, small-scale aquaponic units are components of some urban or peri-urban agriculture initiatives, particularly with non-governments organizations and other stakeholders in urban food and nutrition

FIGURE 1.9
Small-scale aquaponic unit



security, because of their ability to be installed in many different urban landscapes. In particular, the Food and Agriculture Organization of the United Nations (FAO) has piloted small-scale aquaponic units on rooftops in The West Bank and Gaza Strip – in response to the chronic food and nutrition security issues seen across the region (Figure 1.10). To date, this pilot project and subsequent scale-up are one of a growing number of examples around the world where aquaponics is being successfully integrated into medium-scale emergency food security interventions. However, many attempts are *ad hoc* and opportunistic, in many cases leading to stand-alone, low-impact interventions, so

caution should be used when evaluating the success of humanitarian aquaponics.

In the recent years there has been a surge of aquaponic conferences worldwide. Furthermore, aquaponics is increasingly a part of conferences on aquaculture and hydroponics. Many of these panels outline the raising concerns among researchers from different backgrounds and specializations, policy makers and stakeholders to find sustainable solutions to ensure a long-lasting growth and secure increased food output for a growing world population.

FIGURE 1.10
Rooftop small-scale aquaponic unit



2. Understanding aquaponics

Building from the initial explanation of aquaponics in Chapter 1, this chapter discusses the biological processes occurring within an aquaponic unit. First, the chapter explains the major concepts and processes involved, including the nitrification process. It then examines the vital role of bacteria and their key biological processes. Finally, there is a discussion of the importance of balancing the aquaponic ecosystem consisting of the fish, plants and bacteria, including how this can be achieved while maintaining an aquaponic unit over time.

2.1 IMPORTANT BIOLOGICAL COMPONENTS OF AQUAPONICS

As described in Chapter 1, aquaponics is a form of integrated agriculture that combines two major techniques, aquaculture and hydroponics. In one continuously recirculating unit, culture water exits the fish tank containing the metabolic wastes of fish. The water first passes through a mechanical filter that captures solid wastes, and then passes through a biofilter that oxidizes ammonia to nitrate. The water then travels through plant grow beds where plants uptake the nutrients, and finally the water returns, purified, to the fish tank (Figure 2.1). The biofilter provides a habitat for bacteria to convert fish waste into accessible nutrients for plants. These nutrients, which are dissolved in the water, are then absorbed by the plants. This process of nutrient removal cleans the water, preventing the water from becoming toxic with harmful forms of nitrogen (ammonia and nitrite), and allows the fish, plants, and bacteria to thrive symbiotically. Thus, all the organisms work together to create a healthy growing environment for one another, provided that the system is properly balanced.

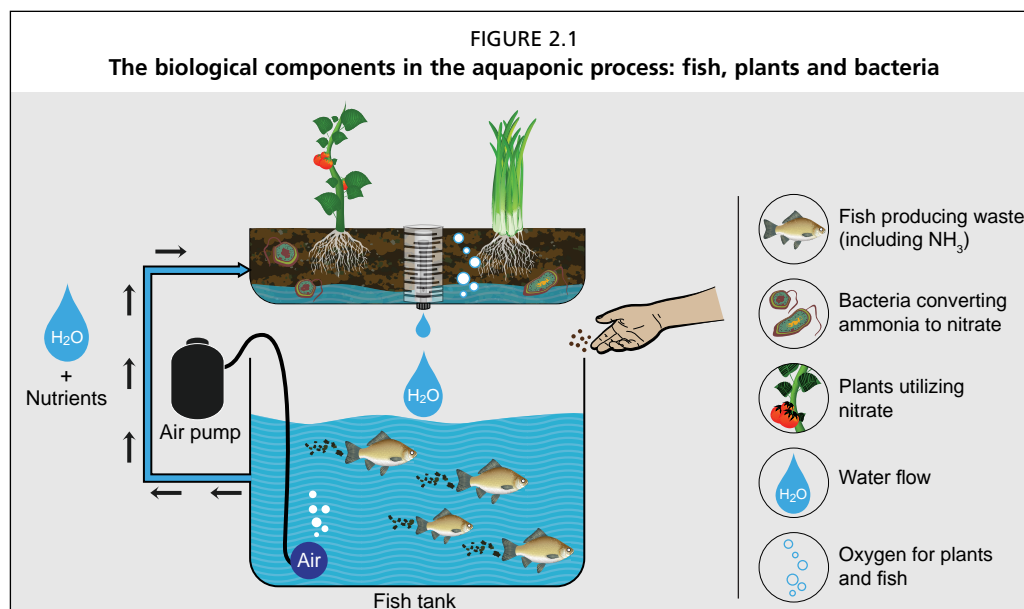

2.1.1 The nitrogen cycle

The most important biological process in aquaponics is the nitrification process, which is an essential component of the overall nitrogen cycle seen in nature. Nitrogen (N) is a chemical element and an essential building block for all life forms. It is present in all amino acids, which make up all proteins which are essential for many key

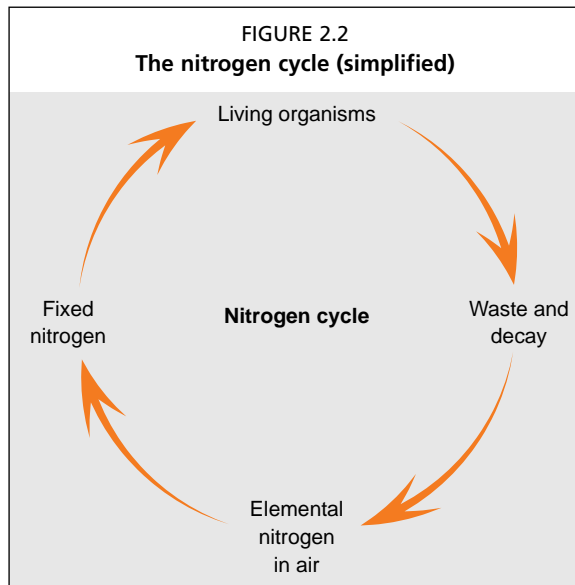

biological processes for animals such as enzyme regulation, cell signalling and the building of structures. Nitrogen is the most important inorganic nutrient for all plants. Nitrogen, in gas form, is actually the most abundant element present in the Earth's atmosphere making up about 78 percent of it, with oxygen only making up 21 percent. Yet, despite nitrogen being so abundant, it is only present in the atmosphere as molecular nitrogen (N_2), which is a very stable triple bond of nitrogen atoms and is inaccessible to plants. Therefore, nitrogen in its N_2 form has to be changed before plants use it for growth. This process is called nitrogen-fixation. It is part of the nitrogen cycle (Figure 2.2), seen throughout nature (Figure 2.3). Nitrogen-fixation is facilitated by bacteria that chemically alter the N_2 by adding other elements such as

hydrogen or oxygen, thereby creating new chemical compounds such as ammonia (NH_3) and nitrate (NO_3^-) that plants can easily use. Also, atmospheric nitrogen can be fixed through an energy-intensive manufacturing process known as the Haber Process, used to produce synthetic fertilizers.

The animal represented in Figure 2.3 produces waste (faeces and urine) that is largely made of ammonia (NH_3). Other decaying organic matter found in nature, such as dead plants or animals, is broken down by fungi and different bacteria groups into ammonia. This ammonia is metabolized by a specific group of bacteria, which is very important for aquaponics, called nitrifying bacteria. These bacteria first convert the ammonia into nitrite compounds (NO_2^-) and then finally into nitrate compounds (NO_3^-). Plants are able to use both ammonia and nitrates to perform their growth processes, but nitrates are more easily assimilated by their roots.

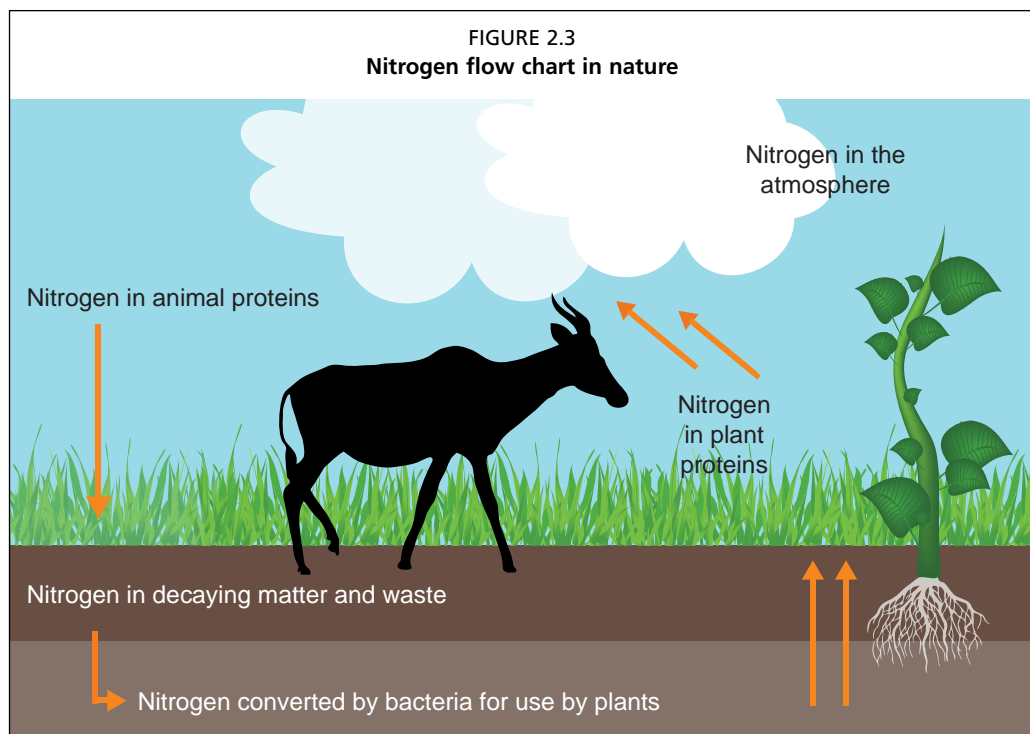

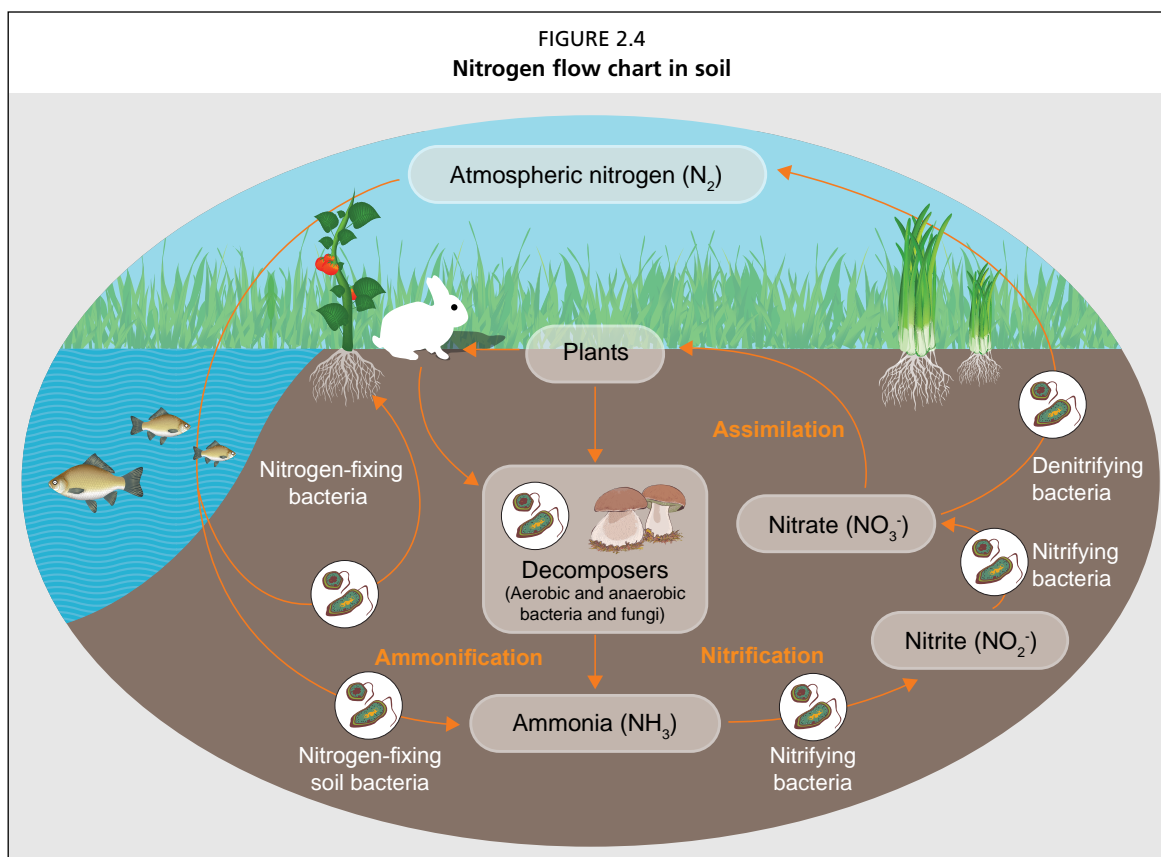

Nitrifying bacteria, which live in diverse environments such as soil, sand, water and air, are an essential component of the nitrification process that converts plant and animal waste into accessible nutrients for plants. Figure 2.4 shows the same process as that illustrated in Figure 2.3, but includes a more complex flow chart showing all the stages of the nitrogen cycle.

This natural process of nitrification by bacteria that happens in soil also takes place in water in the same way. For aquaponics, the animal wastes are the fish excreta released in the culture tanks. The same nitrifying bacteria that live on land will also naturally establish in the water or on every wet surface, converting ammonia from fish waste into the easily assimilated nitrate for plants to use. Nitrification in aquaponic systems provides nutrients for the plants and eliminates ammonia and nitrite which are toxic (Figure 2.5).

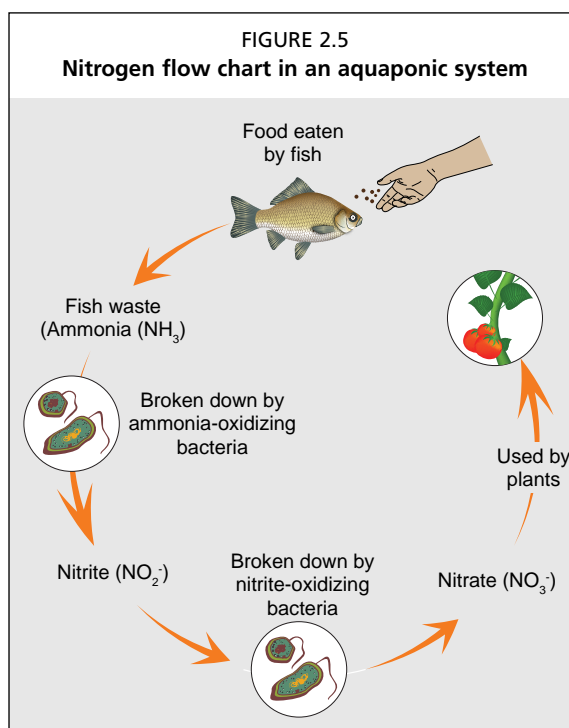

2.2 THE BIOFILTER

Nitrifying bacteria are vital for the overall functioning of an aquaponic unit. Chapter 4 describes how the biofilter component for each aquaponic method works, and Chapter 5 describes the different bacteria groups that operate in an aquaponic unit. Two major groups of nitrifying bacteria are involved in the nitrification process: 1) the

ammonia-oxidizing bacteria (AOB), and 2) the nitrite-oxidizing bacteria (NOB) (Figure 2.6). They metabolize the ammonia in the following order:

1. AOB bacteria convert ammonia (NH_3) into nitrite (NO_2^-)
2. NOB bacteria then convert nitrite (NO_2^-) into nitrate (NO_3^-)

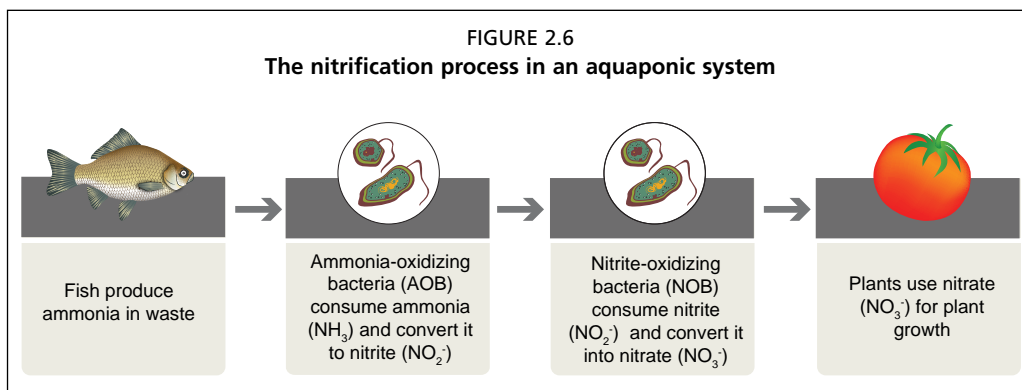

As shown in the chemical symbols, the AOB oxidize (add oxygen to) the ammonia and create nitrite (NO_2^-) and the NOB further oxidize the nitrite (NO_2^-) into nitrate (NO_3^-). The genus *Nitrosomonas* is the most common AOB in aquaponics, and the genus *Nitrobacter* is the most common NOB; these names are frequently used interchangeably in the literature and are used throughout this publication.

In summary, the ecosystem within the aquaponic unit is totally reliant on the bacteria. If the bacteria are not present or if they are not functioning properly, ammonia concentrations in the water will kill the fish. It is vital to keep and manage a healthy bacterial colony in the system at all times in order to keep ammonia levels close to zero.

2.3 MAINTAINING A HEALTHY BACTERIAL COLONY

The major parameters affecting bacteria growth that should be considered when maintaining a healthy biofilter are adequate surface area and appropriate water conditions.

2.3.1 Surface area

Bacterial colonies will thrive on any material, such as plant roots, along fish tank walls and inside each grow pipe. The total available area available for these bacteria will determine how much ammonia they are able to metabolize. Depending on the fish biomass and system design, the plant roots and tank walls can provide adequate area. Systems with high fish stocking density require a separate biofiltration component

where a material with a high surface area is contained, such as inert grow media – gravel, tuff or expanded clay (Figure 2.7).

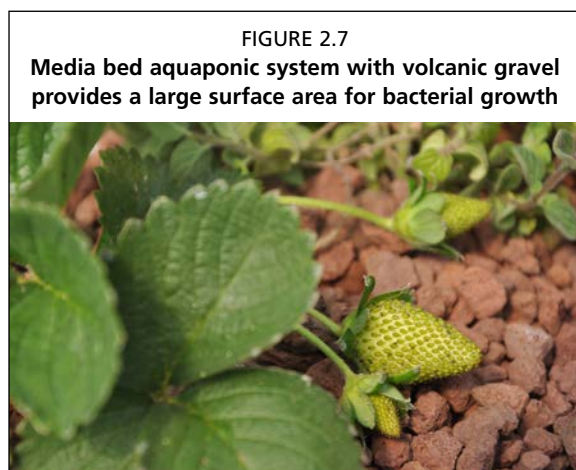

2.3.2 Water pH

The pH is how acidic or basic the water is. The pH level of the water has an impact on the biological activity of the nitrifying bacteria and their ability to convert ammonia and nitrite (Figure 2.8). The ranges for the two nitrifying groups below have been identified as ideal, yet the literature on bacteria growth also suggests a much larger tolerance range (6–8.5) because of the ability of bacteria to adapt to their surroundings.

However, for aquaponics, a more appropriate pH range is 6–7 because this range is better for the plants and fish (Chapter 3 discusses the compromise on water quality parameters). Moreover, a loss of bacterial efficiency can be offset by having more bacteria, thus biofilters should be sized accordingly.

Nitrifying bacteria	Optimal pH
<i>Nitrosomonas</i> spp.	7.2–7.8
<i>Nitrobacter</i> spp.	7.2–8.2

2.3.3 Water temperature

Water temperature is an important parameter for bacteria, and for aquaponics in general. The ideal temperature range for bacteria growth and productivity is 17–34 °C. If the water temperature drops below 17 °C, bacteria productivity will decrease. Below 10 °C, productivity can be reduced by 50 percent or more. Low temperatures have major impacts on unit management during winter (see Chapter 8).

2.3.4 Dissolved oxygen

Nitrifying bacteria need an adequate level of dissolved oxygen (DO) in the water at all times in order to maintain high levels of productivity. Nitrification is an oxidative reaction, where oxygen is used as a reagent; without oxygen, the reaction stops. Optimum levels of DO are 4–8 mg/litre. Nitrification will decrease if DO concentrations drop below 2.0 mg/litre. Moreover, without sufficient DO concentrations, another type of bacteria can grow, one that will convert the valuable nitrates back into unusable molecular nitrogen in an anaerobic process known as denitrification.

2.3.5 Ultraviolet light

Nitrifying bacteria are photosensitive organisms, meaning that ultraviolet (UV) light from the sun is a threat. This is particularly the case during the initial formation of the bacteria colonies when a new aquaponic system is set up. Once the bacteria have colonized a surface (3–5 days), UV light poses no major problem. A simple way to remove this threat is to cover the fish tank and filtration components with UV protective material while making sure no water in the hydroponic component is exposed to the sun, at least until the bacteria colonies are fully formed.

Nitrifying bacteria will grow on material with a high surface area (Figure 2.9), sheltered using UV protective material, and under appropriate water conditions (Table 2.1).

FIGURE 2.8
Digital pH and temperature meter



FIGURE 2.9
Aerated biofilter (a) containing plastic filter medium (b)

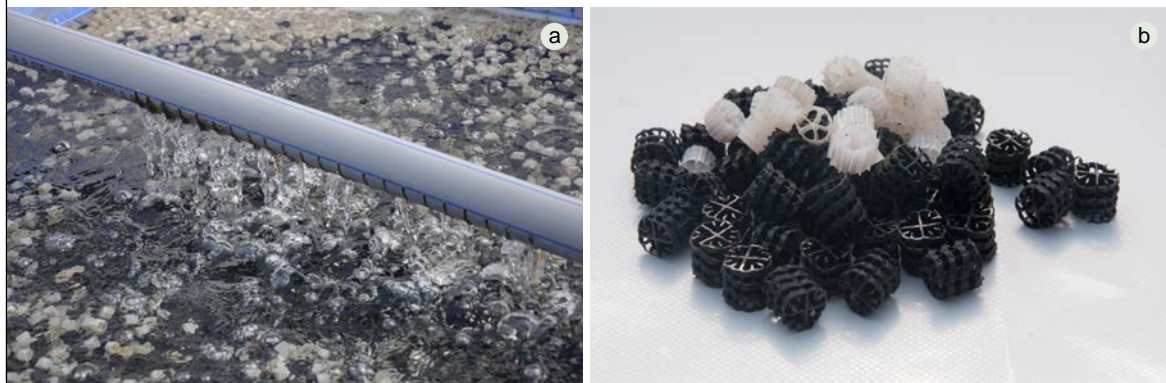

TABLE 2.1
Water quality tolerance ranges for nitrifying bacteria

	Temperature (°C)	pH	Ammonia (mg/litre)	Nitrite (mg/litre)	Nitrate (mg/litre)	DO (mg/litre)
Tolerance Range	17–34	6–8.5	< 3	< 3	< 400	4–8

2.4 BALANCING THE AQUAPONIC ECOSYSTEM

The term *balancing* is used to describe all the measures an aquaponic farmer takes to ensure that the ecosystem of fish, plants and bacteria is at a dynamic equilibrium. It cannot be overstated that successful aquaponics is primarily about maintaining a balanced ecosystem. Simply put, this means that there is a balance between the amount of fish, the amount of plants and the size of the biofilter, which really means the amount of bacteria. There are experimentally determined ratios between biofilter size, planting density and fish stocking density for aquaponics. It is unwise, and very difficult, to operate beyond these optimal ratios without risking disastrous consequences for the overall aquaponic ecosystem. Advanced aquaponic practitioners are invited to experiment and adjust these ratios, but it is recommended to begin aquaponics following these ratios. This section provides a brief, but essential, introduction to balancing a system. Biofilter sizes and stocking densities are covered in much greater depth in Chapter 8.

2.4.1 Nitrate balance

The equilibrium in an aquaponic system can be compared with a balancing scale where fish and plants are the weights standing at opposite arms. The balance's arms are made of nitrifying bacteria. It is thus fundamental that the biofiltration is robust enough to support the other two components. This corresponds to the thickness of the lever in Figure 2.10. Note that the arms were not strong enough to support the amount of fish waste and that the arm broke. This means that the biofiltration was insufficient.

If the fish biomass and biofilter size are in balance, the aquaponic unit will adequately process the ammonia into nitrate. However, if the plant component is undersized, then the system will start to accumulate nutrients (Figure 2.11). In practical terms, higher concentrations of nutrients are not harmful to fish nor plants, but they are an indication that the system is underperforming on the plant side.

A common management mistake is when too many plants and too few fish are used, as seen in the third scenario shown in Figure 2.12. In this case, ammonia is processed by nitrifying bacteria, but the amount of resulting nitrate and other nutrients is insufficient to cover the plants' needs. This condition eventually leads to a progressive reduction in nutrient concentrations and, consequently, plant yields.

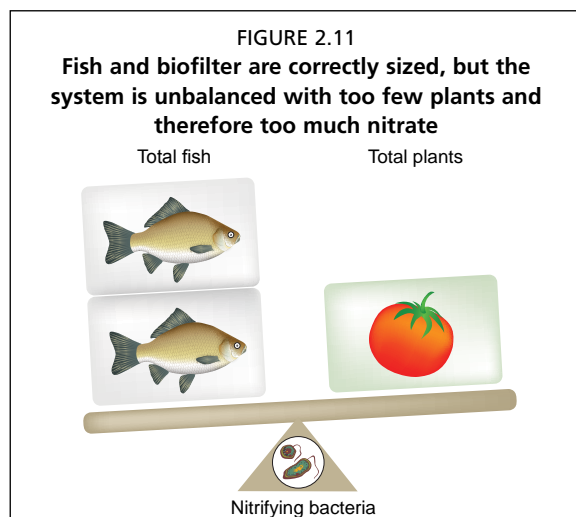
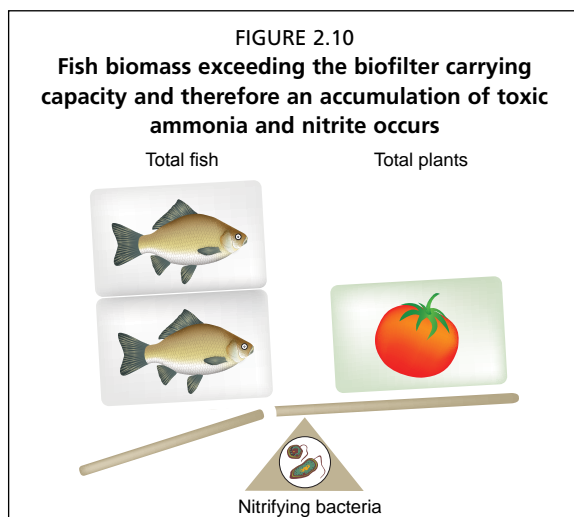

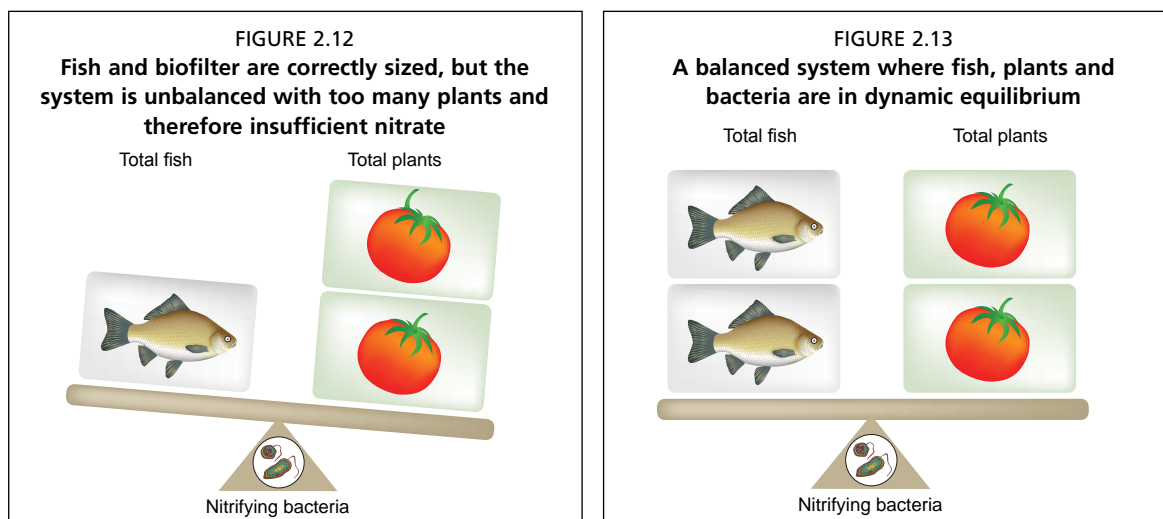

The major lesson from both examples is that achieving maximum production from aquaponics requires the maintaining of an appropriate balance between fish waste and vegetable nutrient demand, while ensuring adequate surface area to grow a bacterial colony in order to convert all the fish wastes. This balanced scenario is shown in Figure 2.13. This balance between fish and plants is also referred to as the biomass ratio. Successful aquaponic units have an appropriate biomass of fish in relation to the number of plants, or more accurately, the ratio of fish feed to plant nutrient demand is balanced. Although it is important to follow the suggested ratios for good aquaponic food production, there is a wide range of workable ratios, and experienced aquaponic farmers will notice how aquaponics becomes a self-regulating system. Moreover, the aquaponic system provides an attentive farmer with warning signs as the system begins to slip out of balance, in the form of water-quality metrics and the health of the fish and plants, all of which are discussed in detail throughout this publication.

2.4.2 Feed rate ratio

Many variables are considered when balancing a system (see Box 2), but extensive research has simplified the method of balancing a unit to a single ratio called the *feed rate ratio*. The feed rate ratio is a summation of the three most important variables, which are: the daily amount of fish feed in grams per day, the plant type (vegetative vs. fruiting) and the plant growing space in square metres. This ratio suggests the amount

BOX 2

The main variables to consider when balancing a unit

- At what capacity will the system function.
- Method of aquaponic production.
- Type of fish (carnivorous vs. omnivorous, activity level).
- Type of fish feed (protein level).
- Type of plants (leafy greens, tubers or fruits).
- Type of plant production (single or multiple species).
- Environmental and water quality conditions.
- Method of filtration.

Recommended daily fish feed rates are:

- for leafy green vegetables: 40–50 grams of feed per square metre per day
- for fruiting vegetables: 50–80 grams of feed per square metre per day

of daily fish feed for every square metre of growing space. It is more useful to balance a system on the amount of feed entering the system than it is to calculate the amount of fish directly. By using the amount of feed, it is then possible to calculate how many fish based on their average daily consumption.

The feed rate ratios will provide a balanced ecosystem for the fish, plants and bacteria, provided there is adequate biofiltration. Use this ratio when designing an aquaponic system. It is important to note that the feed rate ratio is only a guide to balancing an aquaponic unit, as other variables may have larger impacts at different stages in the season, such as seasonal changes in water temperature. The higher feed rate ratio for fruiting vegetables accounts for the greater amount of nutrients needed for these plants to produce flowers and fruits compared with leafy green vegetables.

Along with the feed rate ratio, there are two other simple and complementary methods to ensure a balanced system: health check, and nitrogen testing.

2.4.3 Health check of fish and plants

Unhealthy fish or plants are often a warning that the system is out of balance. Symptoms of deficiencies on the plants usually indicate that not enough nutrients from fish waste are being produced. Nutrient deficiencies often manifest as poor growth, yellow leaves and poor root development, all of which are discussed in Chapter 6. In this case, the fish stocking density, feed (if eaten by fish) and biofilter can be increased, or plants can be removed. Similarly, if fish exhibit signs of stress, such as gasping at the surface, rubbing on the sides of the tank, or showing red areas around the fins, eyes and gills, or in extreme cases dying, it is often because of a buildup of toxic ammonia or nitrite levels. This often happens when there is too much dissolved waste for the biofilter component to process. Any of these symptoms in the fish or plants indicates that the farmer needs to actively investigate and rectify the cause.

2.4.4 Nitrogen testing

This method involves testing the nitrogen levels in the water using simple and inexpensive water test kits (Figure 2.14). If ammonia or nitrite are high (> 1 mg/litre), it indicates that the biofiltration is inadequate and the biofilter surface area available should be increased. Most fish are intolerant of these levels for more than a few days. An increasing level of nitrate is desired, and implies sufficient levels of the other nutrients required for plant growth. Fish can tolerate elevated levels of nitrate, but if the levels remain high (> 150 mg/litre) for several weeks some of the water should be removed and used to irrigate other crops.

If nitrate levels are low (< 10 mg/litre) over a period of several weeks, the fish feed can be increased slightly to make sure there are enough nutrients for the vegetables. However, never leave uneaten fish feed in the aquaculture tank, so increasing the stocking density of the fish may be necessary.

Alternatively, plants can be removed so that there are enough nutrients for those that remain. It is worthwhile and recommended to test for nitrogen levels every week to make sure the system is properly balanced. Moreover, nitrate levels are an indicator of the level of other nutrients in the water.

Again, all of the calculations and ratios mentioned above, including fish stocking density, planting capacity and biofilter sizes, are explained in much greater depth in the following chapters (especially in Chapter 8). The aim of this section was to provide an understanding of



how vital it is to balance the ecosystem within aquaponics and to highlight the simple methods and strategies to do so.

2.5 CHAPTER SUMMARY

- Aquaponics is a production system that combines fish farming with soil-less vegetable production in one recirculating system.
- Nitrifying bacteria convert fish waste (ammonia) into plant food (nitrate).
- The same nitrification process that happens in soil also happens in the aquaponic system.
- The most important part of aquaponics, the bacteria, is invisible to the naked eye.
- The key factors for maintaining healthy bacteria are water temperature, pH, dissolved oxygen and adequate surface area on which the bacteria can grow.
- Successful aquaponic systems are balanced. The *feed rate ratio* is the main guideline to balance the amount of fish feed to plant growing area, which is measured in grams of daily feed per square metre of plant growing space.
- The feed rate ratio for leafy vegetables is 40–50 g/m²/day; fruiting vegetables require 50–80 g/m²/day.
- Daily health monitoring of the fish and the plants will provide feedback on the balance of the system. Disease, nutritional deficiencies and death are symptoms of an unbalanced system.
- Water testing will provide information on the balance of the system. High ammonia or nitrite indicates insufficient biofiltration; low nitrate indicates too many plants or not enough fish; increasing nitrate is desirable and indicates adequate nutrients for the plants, though water needs to be exchanged when nitrate is greater than 150 mg/litre.

3. Water quality in aquaponics

This chapter describes the basic concepts of managing the water within an aquaponic system. The chapter begins by setting the framework and comments on the importance of good water quality for successful aquaponic food production. Following this, the major water quality parameters are discussed in detail. Management and manipulation of some of the parameters are discussed, especially in regard to sourcing water when replenishing an aquaponic unit.

Water is the life-blood of an aquaponic system. It is the medium through which all essential macro- and micronutrients are transported to the plants, and the medium through which the fish receive oxygen. Thus, it is one of the most important topics to understand. Five key water quality parameters are discussed: dissolved oxygen (DO), pH, temperature, total nitrogen, and water alkalinity. Each parameter has an impact on all three organisms in the unit (fish, plants and bacteria), and understanding the effects of each parameter is crucial. Although some aspects of the knowledge on water quality and water chemistry needed for aquaponics seem complicated, the actual management is relatively simple with the help of simple test kits (Figure 3.1). Water testing is essential to keeping good water quality in the system.

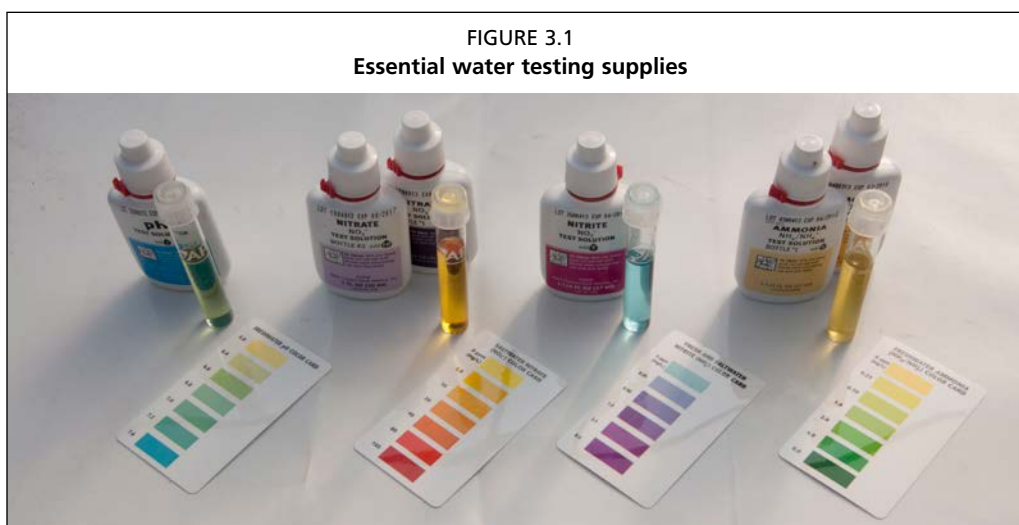

3.1 WORKING WITHIN THE TOLERANCE RANGE FOR EACH ORGANISM

As discussed in Chapter 2, aquaponics is primarily about balancing an ecosystem of three groups of organisms: fish, plants and bacteria (Figure 3.2). Each organism in an aquaponic unit has a specific tolerance range for each parameter of water quality (Table 3.1). The tolerance ranges are relatively similar for all three organisms, but there is need for compromise and therefore some organisms will not be functioning at their optimum level.

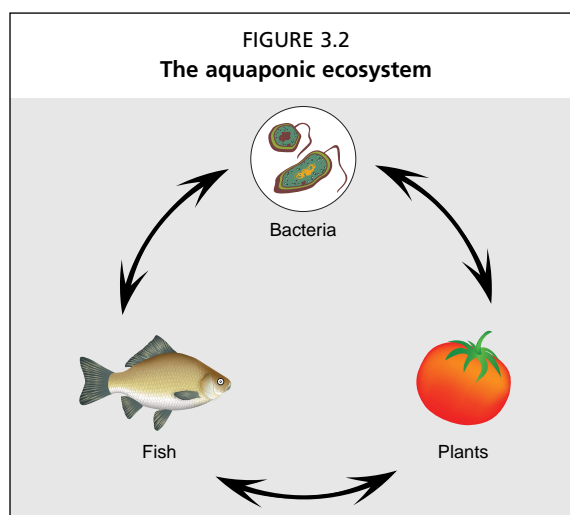

TABLE 3.1
General water quality tolerances for fish (warm- or cold-water), hydroponic plants and nitrifying bacteria

Organism type	Temp (°C)	pH	Ammonia (mg/litre)	Nitrite (mg/litre)	Nitrate (mg/litre)	DO (mg/litre)
Warm water fish	22–32	6–8.5	< 3	< 1	< 400	4–6
Cold water fish	10–18	6–8.5	< 1	< 0.1	< 400	6–8
Plants	16–30	5.5–7.5	< 30	< 1	-	> 3
Bacteria	14–34	6–8.5	< 3	< 1	-	4–8

Table 3.2 illustrates the ideal compromise for aquaponics that is needed for the key water quality parameters. The two most important parameters to balance are pH and temperature. It is recommended that the pH be maintained at a compromised level of 6–7, or slightly acidic.

TABLE 3.2
Ideal parameters for aquaponics as a compromise between all three organisms

	Temp (°C)	pH	Ammonia (mg/litre)	Nitrite (mg/litre)	Nitrate (mg/litre)	DO (mg/litre)
Aquaponics	18–30	6–7	< 1	< 1	5–150	> 5

The general temperature range is 18–30 °C, and should be managed in regard to the target fish or plant species cultivated; bacteria thrive throughout this range. It is important to choose appropriate pairings of fish and plant species that match well with the environmental conditions. Chapter 7 and Appendix 1 describe the optimal growing temperatures of common fish and plants.

The overall goal is to maintain a healthy ecosystem with water quality parameters that satisfy the requirements for growing fish, vegetables and bacteria simultaneously. There are occasions when the water quality will need to be actively manipulated to meet these criteria and keep the system functioning properly.

3.2 THE FIVE MOST IMPORTANT WATER QUALITY PARAMETERS

3.2.1 Oxygen

Oxygen is essential for all three organisms involved in aquaponics; plants, fish and nitrifying bacteria all need oxygen to live. The DO level describes the amount of molecular oxygen within the water, and it is measured in milligrams per litre. It is the water quality parameter that has the most immediate and drastic effect on aquaponics. Indeed, fish may die within hours when exposed to low DO within the fish tanks. Thus, ensuring adequate DO levels is crucial to aquaponics. Although monitoring DO levels is very important, it can be challenging because accurate DO measuring devices can be very expensive or difficult to find. It is often sufficient for small-scale units to instead rely on frequent monitoring of fish behaviour and plant growth, and ensuring water and air pumps are constantly circulating and aerating the water.

Oxygen dissolves directly into the water surface from the atmosphere. In natural conditions, fish can survive in such water, but in intensive production systems with higher fish densities, this amount of DO diffusion is insufficient to meet the demands of fish, plants and bacteria. Thus, the DO needs to be supplemented through management strategies. The two strategies for small-scale aquaponics are to use water pumps to create dynamic water flow, and to use aerators that produce air bubbles in the water. Water movement and aeration are critical aspects of every aquaponic unit, and their importance cannot be overstressed. These topics, including methods of design and redundancy, are discussed further in Chapter 4. The optimum DO levels for each organism to thrive are 5–8 mg/litre (Figure 3.3). Some species of fish,

including carp and tilapia, can tolerate DO levels as low as 2–3 mg/litre, but it is much safer to have the levels higher for aquaponics, as all three organisms demand the use of the DO in the water.

Water temperature and DO have a unique relationship that can affect aquaponic food production. As water temperature rises, the solubility of oxygen decreases. Put another way, the capacity of water to hold DO decreases as temperature increases; warm water holds less oxygen than does cold water (Figure 3.4). As such, it is recommended that aeration be increased using air pumps in warm locations or during the hottest times of the year, especially if raising delicate fish.

3.2.2 pH

A general knowledge of pH is useful for managing aquaponic systems. The pH of a solution is a measure of how acidic or basic the solution is on a scale ranging from 1 to 14. A pH of 7 is neutral; anything below 7 is acidic, while anything above 7 is basic. The term pH is defined as the amount of hydrogen ions (H^+) in a solution; the more hydrogen ions, the more acidic.

Two important aspects of the pH scale are illustrated in Figure 3.5.

- The pH scale is negative; a pH of 7 has fewer hydrogen ions than a pH of 6.
- The pH scale is logarithmic; a pH of 7 has 10 times fewer hydrogen ions than a pH of 6, 100 times fewer than a pH of 5, and 1 000 times fewer than a pH of 4.

For example, if the pH of an aquaponic unit is recorded as 7, and later the value is recorded as 8, the water now has ten times fewer freely associated H^+ ions because the scale is negative and logarithmic. It is important to be aware of the logarithmic nature of the pH scale because it is not necessarily intuitive. For the previous example, if a later reading showed the pH to be 9, the problem would be 100 times worse, and therefore hypercritical, instead of just being two times worse.

Importance of pH

The pH of the water has a major impact on all aspects of aquaponics, especially the plants and bacteria. For plants, the pH controls the plants' access to micro- and macronutrients. At a pH of 6.0–6.5, all of the nutrients are readily available,

FIGURE 3.3
General dissolved oxygen tolerances for fish

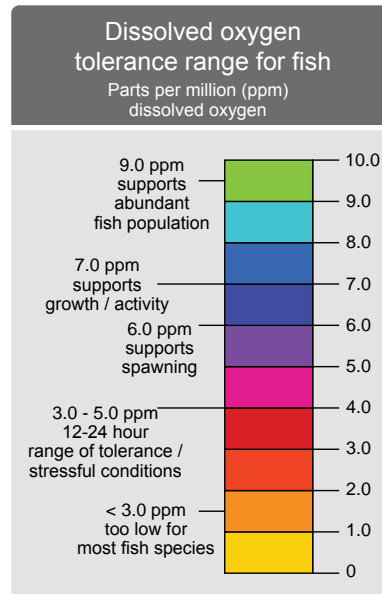

FIGURE 3.4
Oxygen solubility in water at different temperatures

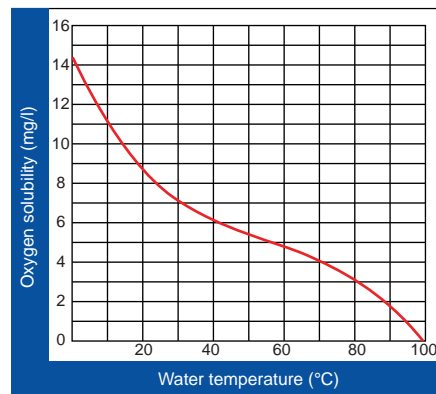
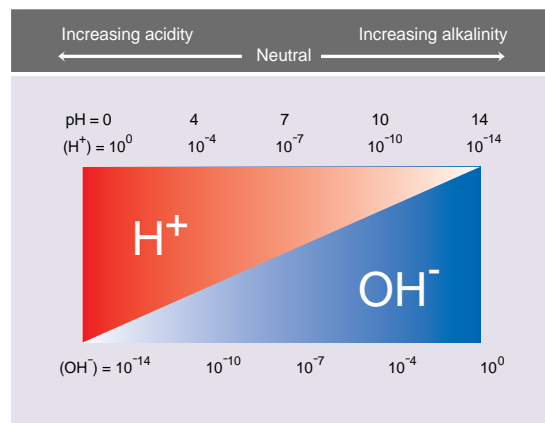

FIGURE 3.5
Visual representation of the pH scale



but outside of this range the nutrients become difficult for plants to access. In fact, a pH of 7.5 can lead to nutrient deficiencies of iron, phosphorus and manganese. This phenomenon is known as nutrient lock-out and is discussed in Chapter 6.

Nitrifying bacteria experience difficulty below a pH of 6, and the bacteria's capacity to convert ammonia into nitrate reduces in acidic, low pH conditions. This can lead to reduced biofiltration, and as a result the bacteria decrease the conversion of ammonia to nitrate, and ammonia levels can begin to increase, leading to an unbalanced system stressful to the other organisms.

Fish have specific tolerance ranges for pH as well, but most fish used in aquaponics have a pH tolerance range of 6.0–8.5. However, the pH affects the toxicity of ammonia to fish, with higher pH leading to higher toxicity. This concept is more fully discussed in the Section 3.4. In conclusion, the ideal aquaponic water is slightly acidic, with an optimum pH range of 6–7. This range will keep the bacteria functioning at a high capacity, while allowing the plants full access to all the essential micro- and macronutrients. pH values between 5.5 and 7.5 require management attention and manipulation through slow and measured means, discussed in Section 3.5 and in Chapter 6. However, a pH lower than 5 or above 8 can quickly become a critical problem for the entire ecosystem and thus immediate attention is required.

There are many biological and chemical processes that take place in an aquaponics system that affect the pH of the water, some more significantly than others, including: the nitrification process; fish stocking density; and phytoplankton.

The nitrification process

The nitrification process of bacteria naturally lowers the pH of an aquaponic system. Weak concentrations of nitric acid are produced from the nitrification process as the bacteria liberate hydrogen ions during the conversion of ammonia to nitrate. Over time, the aquaponic system will gradually become more acidic primarily as a result of this bacterial activity.

Fish stocking density

The respiration, or breathing, of the fish releases carbon dioxide (CO₂) into the water. This carbon dioxide lowers pH because carbon dioxide converts naturally into carbonic acid (H₂CO₃) upon contact with water. The higher the fish stocking density of the unit, the more carbon dioxide will be released, hence lowering the overall pH level. This effect is increased when the fish are more active, such as at warmer temperatures.

Phytoplankton

Respiration by fish lowers the pH by releasing carbon dioxide into the water; conversely, the photosynthesis of plankton, algae and aquatic plants remove carbon dioxide from the water and raises the pH. The effect of algae on pH follows a daily pattern, where the pH rises during the day as the aquatic plants photosynthesize and remove carbonic acid, and then falls overnight as the plants respire and release carbonic acid. Therefore, the pH is at a minimum at sunrise and a maximum at sunset. In standard RAS or aquaponic systems, phytoplankton levels are usually low and, therefore, the daily pH cycle is not affected. However, some aquaculture techniques, such as pond aquaculture and some fish breeding techniques, deliberately use phytoplankton, so the time of monitoring should be chosen wisely.

3.2.3 Temperature

Water temperature affects all aspects of aquaponic systems. Overall, a general compromise range is 18–30 °C. Temperature has an effect on DO as well as on the toxicity (ionization) of ammonia; high temperatures have less DO and more unionized (toxic) ammonia. Also, high temperatures can restrict the absorption of calcium in

plants. The combination of fish and plants should be chosen to match the ambient temperature for the systems' location, and changing the temperature of the water can be very energy-intensive and expensive. Warm-water fish (e.g. tilapia, common carp, catfish) and nitrifying bacteria thrive in higher water temperatures of 22–29 °C, as do some popular vegetables such as okra, Asian cabbages, and basil. Contrarily, some common vegetables such as lettuce, Swiss chard and cucumbers grow better in cooler temperatures of 18–26 °C, and cold-water fish such as trout will not tolerate temperatures higher than 18 °C. For more information on optimal temperature ranges for individual plants and fish, see Chapters 6 and 7 on plant and fish production, respectively, and Appendix 1 for key growing information on 12 popular vegetables.

Although it is best to choose plants and fish already adapted to the local climate, there are management techniques that can minimize temperature fluctuations and extend the growing season. Systems are also more productive if the daily, day to night, temperature fluctuations are minimal. Therefore, the water surface itself, in all of the fish tanks, hydroponic units and biofilters, should be shielded from the sun using shade structures. Similarly, the unit can be thermally protected using insulation against cool night temperatures wherever these occur. Alternatively, there are methods to passively heat aquaponic units using greenhouses or solar energy with coiled agricultural pipes, which are most useful when temperatures are lower than 15 °C; these methods are described in more detail in Chapters 4 and 9.

It is also possible to adopt a fish production strategy to cater for temperature differences between winter and summer, particularly if the winter season has average temperatures of less than 15 °C for more than three months. Generally, this means cold-adapted fish and plants are grown during winter, and the system is changed over to warm-water fish and plants as the temperatures climb again in spring. If these methods are not feasible during cold winter seasons, it is also possible to simply harvest the fish and plants at the start of winter and shut down the systems until spring. During summer seasons with extremely warm temperatures (more than 35 °C), it is essential to select the appropriate fish and plants to grow (see Chapters 6 and 7) and shade all containers and the plant growing space.

3.2.4 Total nitrogen: ammonia, nitrite, nitrate

Nitrogen is the fourth crucial water quality parameter. It is required by all life, and part of all proteins. Nitrogen originally enters an aquaponic system from the fish feed, usually labelled as crude protein and measured as a percentage. Some of this protein is used by the fish for growth, and the remainder is released by the fish as waste. This waste is mostly in the form of ammonia (NH_3) and is released through the gills and as urine. Solid waste is also released, some of which is converted into ammonia by microbial activity. This ammonia is then nitrified by bacteria, discussed in Section 2.1, and converted into nitrite (NO_2^-) and nitrate (NO_3^-). Nitrogenous wastes are poisonous to fish at certain concentrations, although ammonia and nitrite are approximately 100 times more poisonous than nitrate. Although toxic to fish, nitrogen compounds are nutritious for plants, and indeed are the basic component of plant fertilizers. All three forms of nitrogen (NH_3 , NO_2^- and NO_3^-) can be used by plants, but nitrate is by far the most accessible. In a fully functioning aquaponic unit with adequate biofiltration, ammonia and nitrite levels should be close to zero, or at most 0.25–1.0 mg/litre. The bacteria present in the biofilter should be converting almost all the ammonia and nitrite into nitrate before any accumulation can occur.

Impacts of high ammonia

Ammonia is toxic to fish. Tilapia and carp can show symptoms of ammonia poisoning at levels as low as 1.0 mg/litre. Prolonged exposure at or above this level will cause damage to the fishes' central nervous system and gills, resulting in loss of equilibrium,

impaired respiration and convulsions. The damage to the gills, often evidenced by red colouration and inflammation on the gills, will restrict the correct functioning of other physiological processes, leading to a suppressed immune system and eventual death. Other symptoms include red streaks on the body, lethargy and gasping at the surface for air. At higher levels of ammonia, effects are immediate and numerous deaths can occur rapidly. However, lower levels over a long period can still result in fish stress, increased incidence of disease and more fish loss.

As discussed above, ammonia toxicity is actually dependent on both pH and temperature, where higher pH and water temperature make ammonia more toxic. Chemically, ammonia can exist in two forms in water, ionized and unionized. Together, these two forms together are called total ammonia nitrogen (TAN), and water testing kits are unable to distinguish between the two. In acidic conditions, the ammonia binds with the excess hydrogen ions (low pH means a high concentration of H^+) and becomes less toxic. This ionized form is called ammonium. However, in basic conditions (high pH, above 7), there are not enough hydrogen ions and the ammonia remains in its more toxic state, and even low levels of ammonia can be highly stressful for the fish. This problem is exacerbated in warm water conditions.

Activity of nitrifying bacteria declines dramatically at high levels of ammonia. Ammonia can be used as an antibacterial agent, and at levels higher than 4 mg/litre it will inhibit and drastically reduce the effectiveness of the nitrifying bacteria. This can result in an exponentially deteriorating situation when an undersized biofilter is overwhelmed by ammonia, the bacteria die and the ammonia increases even more.

Impacts of high nitrite

Nitrite is toxic to fish. Similar to ammonia, problems with fish health can arise with concentrations as low as 0.25 mg/litre. High levels of NO_2^- can immediately lead to rapid fish deaths. Again, even low levels over an extended period can result in increased fish stress, disease and death.

Toxic levels of NO_2^- prevent the transport of oxygen within the bloodstream of fish, which causes the blood to turn a chocolate-brown colour and is sometimes known as “brown blood disease”. This effect can be seen in fish gills as well. Affected fish exhibit similar symptoms to ammonia poisoning, particularly where fish appear to be oxygen-deprived, seen gasping at the surface even in water with a high concentration of DO. Fish health is covered in more detail in Chapter 7.

Impacts of high nitrate

Nitrate is a far less toxic than the other forms of nitrogen. It is the most accessible form of nitrogen for plants, and the production of nitrate is the goal of the biofilter. Fish can tolerate levels of up to 300 mg/litre, with some fish tolerating levels as high as 400 mg/litre. High levels (> 250 mg/litre) will have a negative impact on plants, leading to excessive vegetative growth and hazardous accumulation of nitrates in leaves, which is dangerous for human health. It is recommended to keep the nitrate levels at 5–150 mg/litre and to exchange water when levels become higher.

3.2.5 Water hardness

The final water quality parameter is water hardness. There are two major types of hardness: general hardness (GH), and carbonate hardness (KH). General hardness is a measure of positive ions in the water. Carbonate hardness, also known as alkalinity, is a measure of the buffering capacity of water. The first type of hardness does not have a major impact on the aquaponic process, but KH has a unique relationship with pH that deserves further explanation.

General hardness

General hardness is essentially the amount of calcium (Ca^{2+}), magnesium (Mg^{2+}) and, to a lesser extent, iron (Fe^{+}) ions present in water. It is measured in parts per million (equivalent to milligrams per litre). High GH concentrations are found in water sources such as limestone-based aquifers and/or river beds, as limestone is essentially composed of calcium carbonate (CaCO_3). Both Ca^{2+} and Mg^{2+} ions are essential plant nutrients, and they are taken up by plants as the water flows through the hydroponic components. Rainwater has low water hardness because these ions are not found in the atmosphere. Hard water can be a useful source of micronutrients for aquaponics, and has no health effects on the organisms. In fact, the presence of calcium in the water can prevent fish from losing other salts and lead to a healthier stock.

Carbonate hardness or alkalinity

Carbonate hardness is the total amount of carbonates (CO_3^{2-}) and bicarbonates (HCO_3^-) dissolved in water. It is also measured in milligrams of CaCO_3 per litre. In general, water is considered to have high KH at levels of 121–180 mg/litre. Water sourced from limestone bedrock wells/aquifers will normally have a high carbonate hardness of about 150–180 mg/litre.

Carbonate hardness in water has an impact on the pH level. Simply put, KH acts as a buffer (or a resistance) to the lowering of pH. Carbonate and bicarbonate present in the water will bind to the H^+ ions released by any acid, thus removing these free H^+ ions from the water. Therefore, the pH will stay constant even as new H^+ ions from the acid are added to the water. This KH buffering is important, because rapid changes in pH are stressful to the entire aquaponic ecosystem. The nitrification process generates nitric acid (HNO_3), as discussed in Section 3.2.2, which is dissociated in water in its two components, hydrogen ions (H^+) and nitrate (NO_3^-), with the latter used as source of nutrients for plants. However, with adequate KH the water does not actually become more acidic. If no carbonates and bicarbonates were present in the water, the pH would quickly drop in the aquaponic unit. The higher the concentration of KH in the water, the longer it will act as a buffer for pH to keep the system stable against the acidification caused by the nitrification process.

The next section describes this process in more detail. It is a rather complicated process but it is important to understand for aquaponics (or other soil-less culture) practitioners where the available water is naturally very hard (which is normally the case in regions with limestone or chalk bedrock), as pH manipulation will become a vital part of unit management. Section 3.5 contains specific techniques of pH manipulation. The summary following the extended description will list what is essential for all practitioners to know regarding hardness.

As mentioned above, the constant nitrification in an aquaponic unit produces nitric acid and increases the number of H^+ ions, which would lower the pH in the water. If no carbonates or bicarbonates are present to buffer the H^+ ions in the water, the pH will quickly drop as more H^+ ions are added into the water. Carbonates and bicarbonates, as shown in Figure 3.6, bind the hydrogen ions (H^+) released from the nitric acid and maintain a constant pH by balancing the surplus of H^+ with the production of carbonic acid, which is a very weak acid. The H^+ ions remain bound to the compound and are

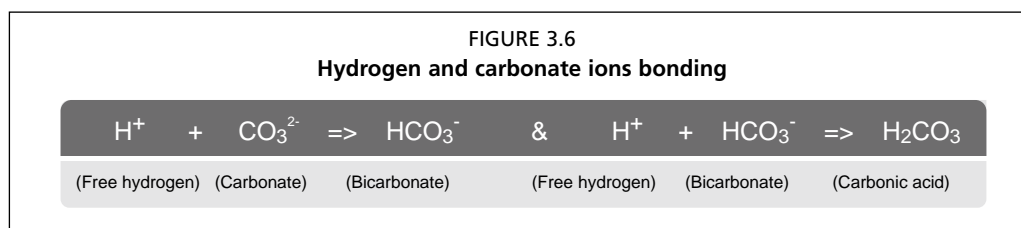

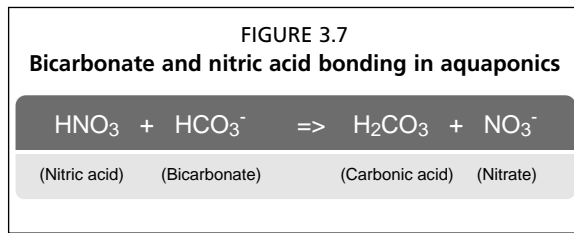

not free in the water. Figure 3.7 shows in more detail the bonding process occurring with nitric acid.

It is essential for aquaponics that a certain concentration of KH is present at all times in the water, as it can neutralize the acids created naturally and keep the pH constant. Without

adequate KH, the unit could be subjected to rapid pH changes that would have negative impacts on the whole system, especially the fish. However, KH is present in many water sources. Replenishing the unit with water from these sources will also replenish the levels of KH. However, rainwater is low in KH, and in rainfed systems it is helpful to add external sources of carbonate, as explained below.

Summary of essential points on hardness

General Hardness (GH) is the measurement of positive ions, especially calcium and magnesium.

Carbonate Hardness (KH) measures the concentration of carbonates and bicarbonates that buffer the pH (create resistance to pH change). Hardness can be classified along the water hardness scale as shown below:

The optimum level of both hardness types for aquaponics is about 60–140 mg/litre. It is not vital to check the levels in the unit, but it is important that the water being used

Water hardness classification	mg/litre
soft	0–60 mg/litre
moderately hard	60–120 mg/litre
hard	120–180 mg/litre
very hard	> 180 mg/litre

to replenish the unit has adequate concentrations of KH to continue neutralizing the nitric acid produced during the nitrification process and to buffer the pH at its optimum level (6–7).

3.3 OTHER MAJOR COMPONENTS OF WATER QUALITY: ALGAE AND PARASITES

3.3.1 Photosynthetic activity of algae

Photosynthetic growth and activity by algae in aquaponic units affect the water quality parameters of pH, DO, and nitrogen levels. Algae are a class of photosynthetic organisms that are similar to plants, and they will readily grow in any body of water that is rich in nutrients and exposed to sunlight. Some algae are microscopic, single-celled organisms called phytoplankton, which can colour the water green (Figure 3.8). Macroalgae are much larger, commonly forming filamentous mats attached to the bottoms and sides of tanks (Figure 3.9).

For aquaponics, it is important to prevent algae growing because they are problematic for several reasons. First, they will consume the nutrients in the water and compete with the target vegetables. In addition, algae act as both a source and sink of DO, producing oxygen during the day through photosynthesis and consuming oxygen at night during respiration. They can dramatically reduce the DO levels in water at night, so causing fish death. This production and consumption of oxygen is related to the production and consumption of carbon dioxide, which causes daily shifts in pH as carbonic acid is either removed (daytime – higher water pH) from or returned (night time – lower water pH) to the system. Finally, filamentous algae can clog drains and block filters within the unit, leading to problems with water circulation. Brown filamentous algae can also grow on the roots of the hydroponic plants, especially in deep water culture, and negatively affects plant growth. However, some aquaculture operations benefit greatly from culturing algae for feed, referred to as green-water culture, including tilapia breeding, shrimp culture, and biodiesel production, but these topics are not directly related to aquaponics and are not discussed here.

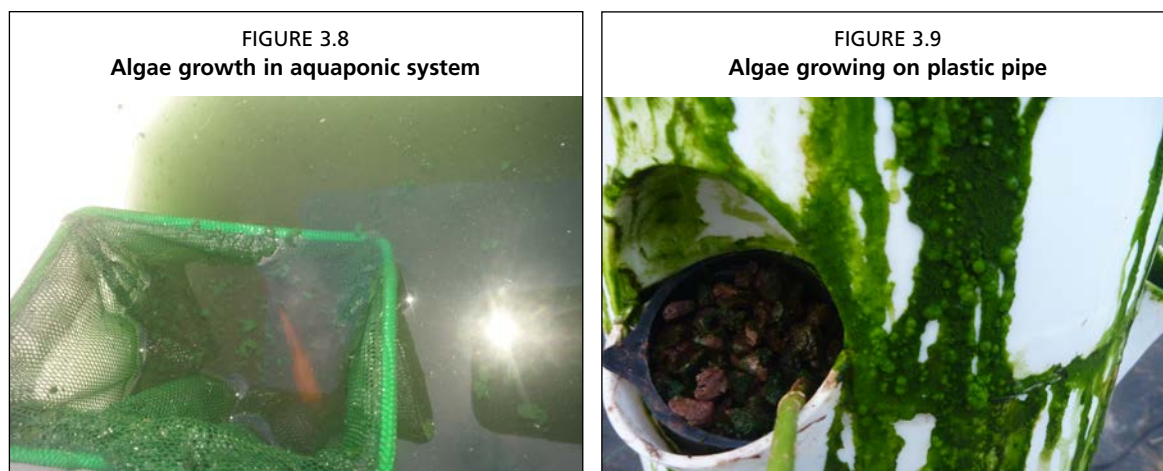

Preventing algae is relatively easy. All water surfaces should be shaded. Shade cloth, tarps, woven palm fronds or plastic lids should be used to cover fish tanks and biofilters such that no water is in direct contact with sunlight. This will inhibit algae from blooming in the unit.

3.3.2 Parasites, bacteria and other small organisms living in the water

Aquaponics is an ecosystem comprised mainly of fish, nitrifying bacteria, and plants. However, over time, there may be many other organisms contributing to this ecosystem. Some of these organisms will be helpful, such as earthworms, and facilitate the decomposition of fish waste. Others are benign, neither helping nor harming the system, such as various crustaceans, living in the biofilters. Others are threats; parasites, pests and bacteria are impossible to avoid completely because aquaponics is not a sterile endeavour. The best management practice to prevent these small threats from becoming dangerous infestations is to grow healthy, stress-free fish and plants by ensuring highly aerobic conditions with access to all essential nutrients. In this way, the organisms can stave off infection or disease using their own healthy immune systems. Chapters 6 and 7 discuss additional management of fish and plant diseases, and Chapter 8 covers food safety and other biothreats in more detail.

3.4 SOURCES OF AQUAPONIC WATER

On average, an aquaponic system uses 1–3 percent of its total water volume per day, depending on the type of plants being grown and the location. Water is used by the plants through natural evapotranspiration as well as being retained within the plant tissues. Additional water is lost from direct evaporation and splashing. As such, the unit will need to be replenished periodically. The water source used will have an impact on the water chemistry of the unit. Below is a description of some common water sources and the common chemical composition of that water. New water sources should always be tested for pH, hardness, salinity, chlorine and for any pollutants in order to ensure the water is safe to use.

Here it is important to consider an additional water quality parameter: salinity. Salinity indicates the concentration of salts in water, which include table salt (sodium chloride – NaCl), as well as plant nutrients, which are in fact salts. Salinity levels will have a large bearing when deciding which water to use because high salinity can negatively affect vegetable production, especially if it is of sodium chloride origin, as sodium is toxic for plants. Water salinity can be measured with an electrical conductivity (EC) meter, a total dissolved solids (TDS) meter, a refractometer, or a hydrometer or operators can refer to local government reports on water quality. Salinity is measured either as conductivity, or how much electricity will pass through the water, as units of

microSiemens per centimetre ($\mu\text{S}/\text{cm}$), or in TDS as parts per thousand (ppt) or parts per million (ppm or mg/litre). For reference, seawater has a conductivity of 50 000 $\mu\text{S}/\text{cm}$ and TDS of 35 ppt (35 000 ppm). Although the impact of salinity on plant growth varies greatly between plants (Section 9.4.2, Appendix 1), it is recommended that low salinity water sources be used. Salinity, generally, is too high if sourcing water has a conductivity more than 1 500 $\mu\text{S}/\text{cm}$ or a TDS concentration of more than 800 ppm. Although EC and TDS meters are commonly used for hydroponics to measure the total amount of nutrient salts in the water, these meters do not provide a precise reading of the nitrate levels, which can be better monitored with nitrogen test kits.

3.4.1 Rainwater

Collected rainwater is an excellent source of water for aquaponics. The water will usually have a neutral pH and very low concentrations of both types of hardness (KH and GH) and almost zero salinity, which is optimal to replenish the system and avoid long-term salinity buildups. However, in some areas affected by acid rain as recorded in a number of localities in eastern Europe, eastern United States of America and areas of southeast Asia, rainwater will have an acidic pH. Generally, it is good practice to buffer rainwater and increase the KH as indicated in Section 3.5.2. In addition, rainwater harvesting will reduce the overhead costs of running the unit, and it is more sustainable.

3.4.2 Cistern or aquifer water

The quality of water taken from wells or cisterns will largely depend on the material of the cistern and bedrock of the aquifer. If the bedrock is limestone, then the water will probably have quite high concentrations of hardness, which may have an impact on the pH of the water. Water hardness is not a major problem in aquaponics, because the alkalinity is naturally consumed by the nitric acid produced by the nitrifying bacteria. However, if the hardness levels are very high and the nitrification is minimal because of small fish biomass, then the water may remain slightly basic (pH 7–8) and resist the natural tendency of aquaponic systems to become acidic through the nitrification cycle and fish respiration. In this case, it may be necessary to use very small amounts of acid to reduce the alkalinity before adding the water to the system in order to prevent pH swings within the system. Aquifers on coral islands often have saltwater intrusion into the freshwater lens, and can have salinity levels too high for aquaponics, so monitoring is necessary and rainwater collection or reverse osmosis filtration may be better options.

3.4.3 Tap or municipal water

Water from the municipal supplies is often treated with different chemicals to remove pathogens. The most common chemicals used for water treatment are chlorine and chloramines. These chemicals are toxic to fish, plants and bacteria; these chemicals are used to kill bacteria in water and as such are detrimental to the health of the overall aquaponic ecosystem. Chlorine test kits are available; and if high levels of chlorine are detected, the water needs to be treated before being used. The simplest method is to store the water before use, thereby allowing all the chlorine to dissipate into the atmosphere. This can take upwards of 48 hours, but can occur faster if the water is heavily aerated with air stones. Chloramines are more stable and do not off-gas as readily. If the municipality uses chloramines, it may be necessary to use chemical treatment techniques such as charcoal filtration or other dechlorinating chemicals. Even so, off-gassing is usually enough in small-scale units using municipal water. A good guideline is to never replace more than 10 percent of the water without testing and removing the chlorine first. Moreover, the quality of the water will depend on the bedrock where the initial water is sourced. Always check new sources of water for

hardness levels and pH, and use acid if appropriate and necessary to maintain the pH within the optimum levels indicated above.

3.4.4 Filtered water

Depending on the type of filtration (i.e. reverse osmosis or carbon filtering), filtered water will have most of the metals and ions removed, making the water very safe to use and relatively easy to manipulate. However, like rainwater, deionized water from reverse osmosis will have low hardness levels and should be buffered.

3.5 MANIPULATING pH

There are simple methods to manipulate the pH in aquaponic units. In regions with limestone or chalk bedrock, the natural water is often hard with high pH. Therefore, periodic acid additions may be necessary to lower the pH. In regions with volcanic bedrock, the natural water will often be soft, with very low alkalinity, indicating a need to periodically add a base or a carbonate buffer to the water to counteract the natural acidification of the aquaponic unit. Base and buffer additions are also required for rainfed systems.

3.5.1 Lowering pH with acid

Aquaponic water naturally acidifies because of nitrification and respiration. With patience, the pH levels often decrease to the target range.

However, adding acid may be necessary if the source water has a high KH and high pH, and there is a high evaporation rate. In these uncommon and exceptional cases, the volume of water to resupply the system is such that it significantly raises the pH above the optimal ranges and overpowers the natural acidification. Adding acid is also necessary if the amount of fish stocked is not sufficient to produce enough dissolved wastes to drive nitrification and the resulting acidification. In these cases, the resupply of water will result in a resupply of the buffering agents, carbonates. The natural acid production will not be sufficient to react with the buffering agents and subsequently lower pH. Only add acid if the source water is very hard and basic and if there is not rainwater that can supply the system with KH-free water to help nitrifying bacteria to naturally lower the pH.

Adding acid to an aquaponics system is dangerous. The danger is that at first the acid reacts with buffers and no pH change is noticed. More and more acid is added with no pH change, until finally all of the buffers have reacted and the pH drops drastically, often resulting in a terrible and stressful shock to the system. It is better practice, if necessary to add acid, to treat a reservoir of this resupply water with acid, and then add the treated water to the system (Figure 3.10). This removes the risk to the system if too much acid is used. The acid should always be added to a volume of resupply water, and extreme care should be used not to add too much acid to the system. If the system is designed with an automatic water supply line it may be necessary to add acid directly to the system, but the danger is increased.

Phosphoric acid (H_3PO_4) can be used to lower the pH. Phosphoric acid is a relatively mild acid. It can be found in food-grade quality from hydroponic or agricultural supply stores under various trade names. Phosphorus is an important macronutrient for plants, but overuse of phosphoric acid can lead to toxic concentration of phosphorous in the system. In situations with extremely hard and basic source water

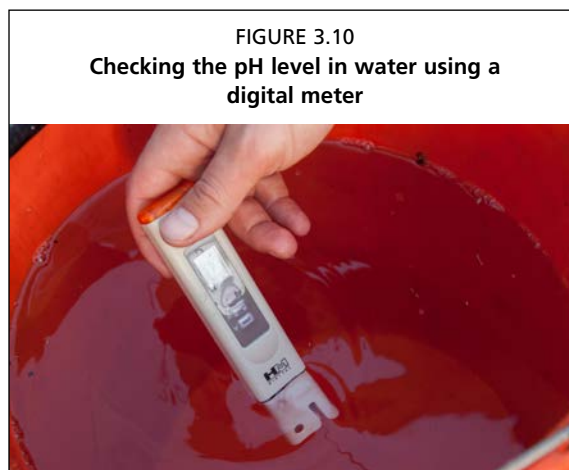

FIGURE 3.11
Phosphoric acid (H_3PO_4 – 85% concentration) used to lower pH



FIGURE 3.12
Adding seashells in a net bag to release carbonate into the aquaponic unit



(high KH, high pH), sulphuric acid (H_2SO_4) has been used. However, owing to its high corrosiveness and even higher level of danger, its use is not recommended to beginners. Nitric acid (HNO_3) has also been used as a relatively neutral acid. Citric acid, while tempting to use, is antimicrobial and can kill the bacteria in the biofilter; citric acid should not be used.

Concentrated acids are dangerous, both to the system and to the operator. Proper safety precautions should be used, including safety goggles and gloves (Figure 3.11). Never add water to acid, always add acid to water.

3.5.2 Increasing pH with buffers or bases

If the pH level drops below 6.0, it is necessary to add a base and/or increase carbonate hardness. Commonly used bases are potassium hydroxide (KOH) and calcium hydroxide ($Ca(OH)_2$). These bases are strong, and should be added in the same way as acids; always change pH slowly. However, a safer and easier solution is to add calcium carbonate ($CaCO_3$) or potassium carbonate (K_2CO_3), which will increase both the KH and pH. There are many natural and inexpensive sources of calcium carbonate that can be added to the system. Some of these include crushed eggshells, finely crushed seashells, coarse limestone grit and crushed chalk. The recommended method is to put the material in a porous bag suspended in the sump tank (Figure 3.12). Continue testing pH over the next few weeks to monitor the increase in pH. Remove the bag if the pH increases above 7. Alternatively, add 2–3 handfuls of these materials per 1 000 litres either straight into the media beds or biofilter component. If using seashells, be sure to rinse away residual salt before adding to the system. The choice of the bases and buffers can also be driven by the type of plants growing in the system, as each of these compounds adds an important macronutrient. Leafy vegetables can

be favoured by calcium bases to avoid tip burns on leaves; while potassium is optimal in fruit plants to favour flowering, fruit settings and optimal ripening.

Sodium bicarbonate (baking soda) is often used to increase carbonate hardness in RASs, but should never be used in aquaponics because of the resulting increase in sodium, which is detrimental to the plants.

3.6 WATER TESTING

In order to maintain good water quality in aquaponic units, it is recommended to perform water tests once per week to make sure all the parameters are within the optimum levels. However, mature and seasoned aquaponic units will have consistent water chemistry and do not need to be tested as often. In these cases water testing is

only needed if a problem is suspected. In addition, daily health monitoring of the fish and the plants growing in the unit will indicate if something is wrong, although this method is not a substitution for water testing.

Access to simple water tests are strongly recommended for every aquaponic unit. Colour-coded freshwater test kits are readily available and easy to use (Figure 3.13). These kits include tests for pH, ammonia, nitrite, nitrate, GH, and KH. Each test involves adding 5–10 drops of a reagent into 5 millilitres of aquaponic water; each test takes no more than five minutes to complete. Other methods include digital pH or nitrate meters (relatively expensive and very accurate) or water test strips (cheapest and moderately accurate, Figure 3.14).

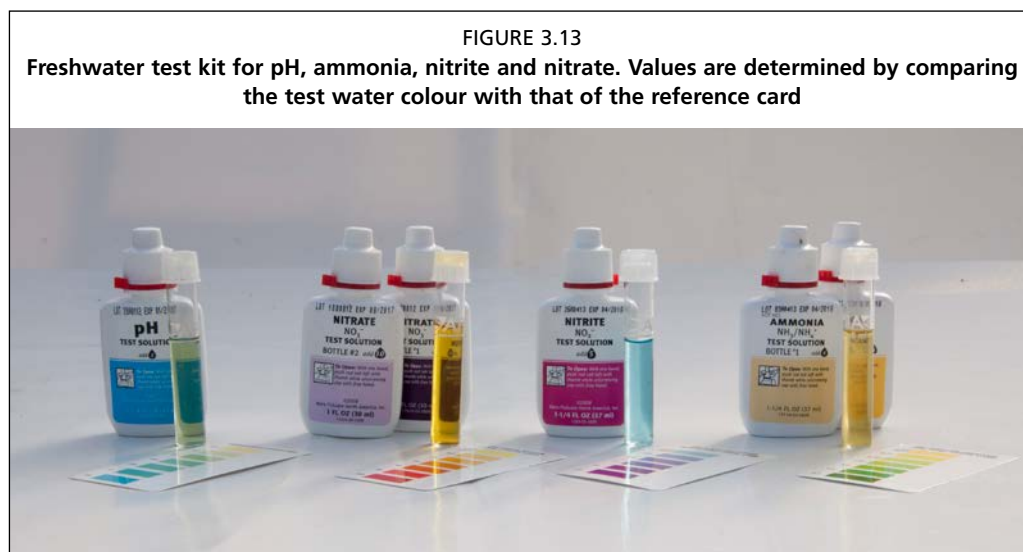

The most important tests to perform weekly are pH, nitrate, carbonate hardness and water temperature, because these results will indicate whether the system is in balance. The results should be recorded each week in a dedicated logbook so trends and changes can be monitored throughout growing seasons. Testing for ammonia and nitrite is also extremely helpful in order to diagnose problems in the unit, especially in new units or if an increase in fish mortality raises toxicity concerns in an ongoing system. Although they are not essential for weekly monitoring in established units, they can provide very strong indicators of how well the bacteria are converting the fish waste and the health of the biofilter. Testing for ammonia and nitrate are the first action if any problems are noticed with the fish or plants.

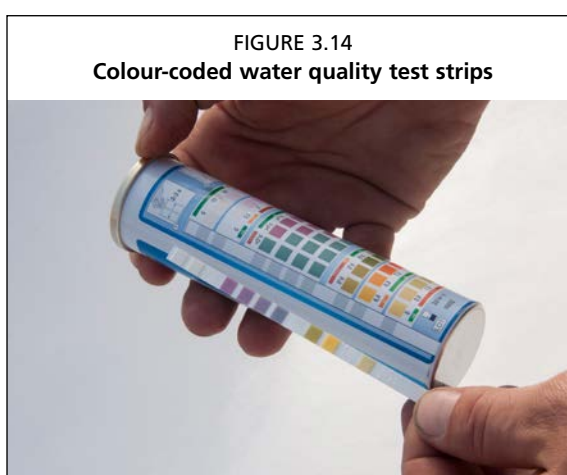

3.7 CHAPTER SUMMARY

- Water is the life-blood of an aquaponic system. It is the medium through which plants receive their nutrients and the fish receive their oxygen. It is very important to understand water quality and basic water chemistry in order to properly manage aquaponics.
- There are five key water quality parameters for aquaponics: dissolved oxygen (DO), pH, water temperature, total nitrogen concentrations and hardness (KH). Knowing the effects of each parameter on fish, plants and bacteria is crucial.

- Compromises are made for some water quality parameters to meet the needs of each organism in aquaponics.
- The target ranges for each parameter are as follows:

pH	6–7
Water temperature	18–30 °C
DO	5–8 mg/litre
Ammonia	0 mg/litre
Nitrite	0 mg/litre
Nitrate	5–150 mg/litre
KH	60–140 mg/litre

- There are simple ways to adjust pH. Bases, and less often acids, can be added in small amounts to the water in order to increase or lower the pH, respectively. Acids and bases should always be added slowly, deliberately and carefully. Rainwater can be alternatively used to let the system naturally lower the pH through nitrifying bacteria consuming the system's alkalinity. Calcium carbonate from limestone, seashells or egg shells increases KH and buffers pH against the natural acidification.
- Some aspects of the water quality and water chemistry knowledge needed for aquaponics can be complicated, in particular the relationship between pH and hardness, but basic water tests are used to simplify water quality management.
- Water testing is essential to maintaining good water quality in the system. Test and record the following water quality parameters each week: pH, water temperature, nitrate and carbonate hardness. Ammonia and nitrite tests should be used especially at system start-up and if abnormal fish mortality raises toxicity concerns.

4. Design of aquaponic units

This chapter discusses the theory and design of aquaponic systems. There are many design aspects to take into consideration, as virtually all environmental and biological factors will have an impact on the aquaponic ecosystem. The aim of this chapter is to present these aspects in the most accessible way and to provide a thorough explanation of each component within an aquaponic unit.

Section 4.1 discusses the factors to consider when selecting a site for an aquaponic unit, including access to sunlight, wind and rain exposure, average temperature and others. Section 4.2 discusses the general aquaponic components essential for any method of aquaponics, including the fish tank, water and air pumps, the biofilter, the plant growing method and associated plumbing materials. The hydroponic component is then discussed in further detail, focusing on the three most common methods used in aquaponics: the media bed method (Figures 4.1–4.5); the nutrient film technique (NFT) method (Figures 4.6–4.9); and the deep water culture (DWC) method (Figures 4.10–4.13).

Method	Abbreviation	Other names	Name of planting area	Section
Deep water culture	DWC	floating raft	canal, trough	4.3
Nutrient film technique	NFT		pipe, gutter	4.4
Media bed	n/a	particulate	bed, tray	4.5

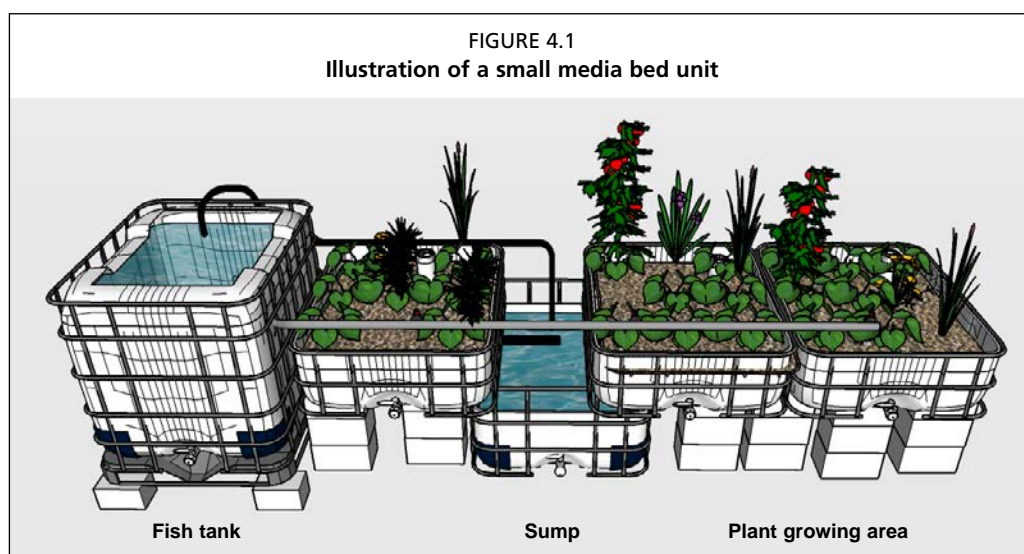

A specific section then presents a particular type of DWC with low stocking density. A final summary table of each method is provided in order to compare and contrast these three methods.

This chapter is intended only to explain the essential unit components and different methods of aquaponics. For more information regarding the sizing and design ratios for different unit components, please see Chapter 8, which provides the more detailed information, figures and design plans needed to actually design and construct small-scale aquaponic units. In addition, Appendix 8 gives a full step-by-step guide to building a small-scale version of the three methods explained in this chapter using materials widely available.

FIGURE 4.2
Example of a newly assembled media bed unit using intermediate bulk containers



FIGURE 4.3
Taro (*Colocasia esculenta*) plants growing in a semi-commercial media bed unit constructed in wood and lined with polyethylene liner



FIGURE 4.4
Lush vegetable growth in a backyard media bed unit



FIGURE 4.5
A media bed unit planted with chili pepper (*Capsicum* spp.)



FIGURE 4.6
Illustration of a small nutrient film technique unit

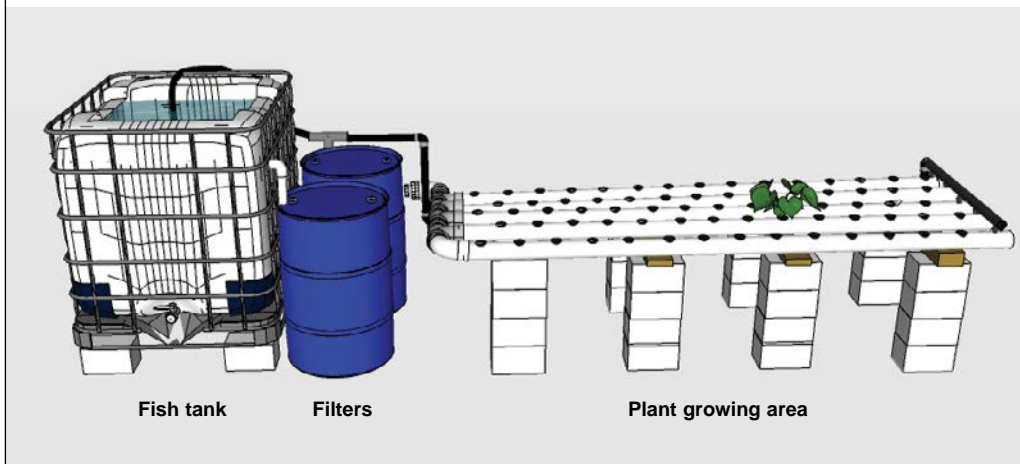

FIGURE 4.7
Parsley (*Petroselinum* sp.) growing in a small nutrient film technique unit

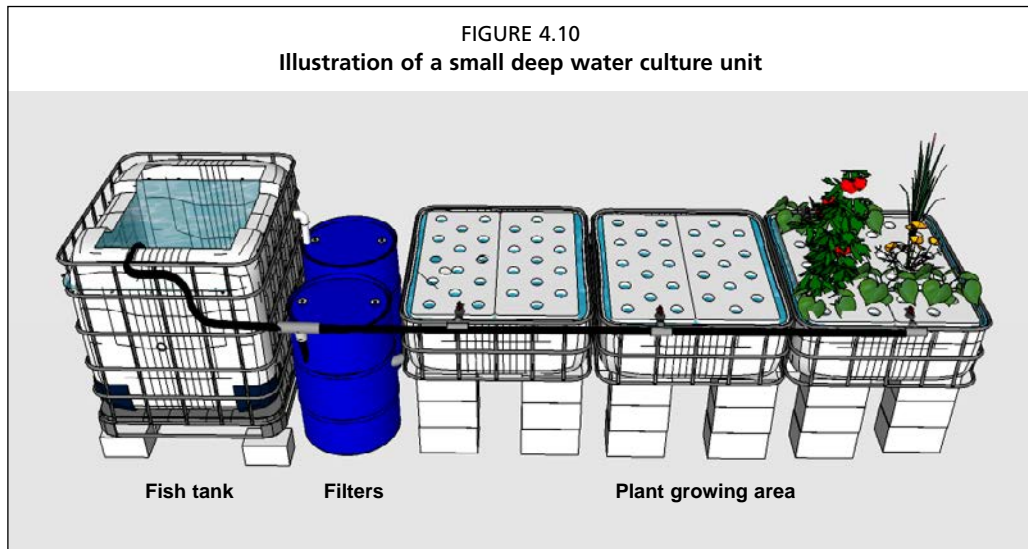

FIGURE 4.8
Farmers tending young tomato plants in a nutrient film technique unit. Net cups are made from recycled plastic bottles with holes in the bottom



FIGURE 4.9
A nutrient film technique unit using vertical space





4.1 SITE SELECTION

Site selection is an important aspect that must be considered before installing an aquaponic unit. This section generally refers to aquaponic units built outdoors without a greenhouse. However, there are brief comments about greenhouses and shading net structures for larger units. It is important to remember that some of the system's components, especially the water and stone media, are heavy and hard to move, so it is worth building the system in its final location. Selected sites should be on a surface

that is stable and level, in an area that is protected from severe weather but exposed to substantial sunlight.

4.1.1 Stability

Be sure to choose a site that is stable and level. Some of the major components of an aquaponic system are heavy, leading to the potential risk of the legs of the system sinking into the ground. This can lead to disrupted water flow, flooding or catastrophic collapse. Find the most level and solid ground available. Concrete slabs are suitable, but do not allow any components to be buried, which can lead to tripping hazards. If the system is built on soil, it is useful to grade the soil and put down material to mitigate weeds. In addition, place concrete or cement blocks under the legs of the grow beds to improve stability. Stone chips are often used to level and stabilize soil locations. Moreover, it is important to place the fish tanks on a base; this will help to provide stability, protect the tank, allow for plumbing and drains on the tank bottom, and thermally isolate it from the ground.

4.1.2 Exposure to wind, rain and snow

Extreme environmental conditions can stress plants and destroy structures (Figure 4.14). Strong prevailing winds can have a considerable negative impact on plant production and can cause damage to stems and reproductive parts. In addition, strong rain can harm the plants and damage unprotected electrical sockets. Large amounts of rain can dilute the nutrient-rich water, and can flood a system if no overflow mechanism is integrated into the unit. Snow causes the same problems as heavy rain, with the added threat of cold damage. It is recommended that the system be located in a wind-protected zone. If heavy rains are common, it may be worth protecting the system with a plastic-lined hoop house, although this may not be necessary in all locations.

4.1.3 Exposure to sunlight and shade

Sunlight is critical for plants, and as such, the plants need to receive the optimum amount of sunlight during the day. Most of the common plants for aquaponics grow well in full sun conditions; however, if the sunlight is too intense, a simple shade structure can be installed over the grow beds. Some light-sensitive plants, including lettuce, salad greens and some cabbages, will bolt in too much sun, go to seed and become bitter and unpalatable. Other tropical plants adapted to the jungle floor such as turmeric and certain ornamentals can exhibit leaf burn when exposed to excessive sun, and they do better with some shade. On the other hand, with insufficient sunlight, some plants can have slow growth rates. This situation can be avoided by placing the aquaponic unit in a sunny location. If a shady area is the only location available, it is recommended that shade-tolerant species be planted.

Systems should be designed to take advantage of the sun travelling from east to west through the sky. Generally, the grow beds should be spatially arranged such that the longest side is on a north–south axis. This makes the most efficient use of the sun during the day. Alternatively, if less light is preferable, orient the beds, pipes and canals following the east–west axis. Also consider where and when there are shadows that cross



FIGURE 4.15
Shade material (blue) filtering sunlight in the fish tank



the chosen site. Be careful in the arrangement of plants such that they do not inadvertently shade one another. However, it is possible to use tall, sun-loving plants to shade low, light-sensitive plants from intense afternoon sun by placing the tall plants to the west or by alternating the two in a scattered distribution.

Unlike the plants, the fish do not need direct sunlight. In fact, it is important for the fish tanks to be in the shade. Normally, the fish tanks are covered with a removable shading material that is placed on top of the tank (Figure 4.15). However, where possible, it is better to isolate the fish tanks using a separate shading structure. This will prevent algae growth (see Chapter 3) and will help to maintain a stable water temperature during the day. It is also worth preventing leaves and organic debris from entering the fish tanks, as the decaying leaf matter can stain the water, affect water chemistry and clog pipes. Either locate the system away from overhanging vegetation or keep the tank covered with a

screen. Moreover, fish tanks are vulnerable to predators. Using shade netting, tarps or other screening over the fish tanks will prevent all of these threats.

4.1.4 Utilities, fences and ease of access

In site selection, it is important to consider the availability of utilities. Electric outlets are needed for water and air pumps. These outlets should be shielded from water and equipped with a residual-current device (RCD) to reduce the risk of electrical shock; RCD adaptors can be purchased from standard hardware stores. Moreover, the water source should be easily accessible, whether it is municipal water or rain collection units. Similarly, consider where any effluent from the system would go. Although extremely water efficient, aquaponic systems occasionally require water changes, and filters and clarifiers need to be rinsed. It is convenient to have some soil plants located nearby that would benefit from this water. The system should be located where it is easy for daily access because frequent monitoring and daily feeding are required. Finally, consider if it is necessary to fence the entire section. Fences are sometimes required to prevent theft and vandalism, animal pests and for some food safety regulations.

FIGURE 4.16
A small media bed unit on a rooftop



4.1.5 Special considerations: rooftop aquaponics

Flat rooftops are often suitable sites for aquaponics because they are level, stable, exposed to sunlight and are not already used for agriculture (Figures 4.16–4.18). However, when building a system on a rooftop it is crucial to consider the weight of the system, and whether or not the roof is capable of supporting it. It is essential to consult with an architect or civil engineer before building a rooftop system. In addition, be sure that materials can be transported both safely and effectively to the rooftop site.

FIGURE 4.17
Multiple aquaponic systems on a rooftop

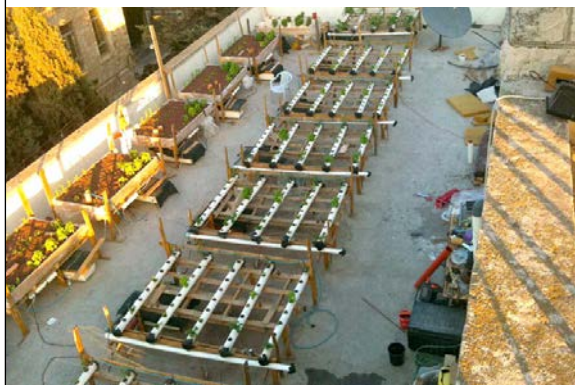

FIGURE 4.18
Variety of vegetables growing on a rooftop in nutrient film technique systems



4.1.6 Greenhouses and shading net structures

Greenhouses are not essential for small-scale aquaponic units, yet they may be useful in extending the growing season in some regions (Figures 4.19 and 4.20). This is particularly true in temperate and other cooler regions around the world, as greenhouses can be used to maintain a warm water temperature during the cold months, thereby allowing year-round production.

A greenhouse is a metal, wood or plastic frame structure that is covered by transparent nylon, plastic or glass. The purpose of this structure is to allow sunlight (solar radiation) to enter the greenhouse and then trap it so it begins heating the air inside the greenhouse. As the sun begins to set, the heat is retained in the greenhouse by the roof and walls, allowing for a warmer and more stable air temperature during a 24-hour period. Greenhouses provide general environmental protection from wind, snow and heavy rain. Greenhouses extend the growing season by retaining ambient solar heat, but can also be heated from within. Greenhouses can keep away animals and other pests, and serve as some security against theft. Greenhouses are comfortable to work in during colder seasons, and provide the grower with protection from the weather. Greenhouse frames can be used to support climbing plants or to hang shade material. Together, these advantages of a greenhouse result in higher productivity and in an extended cropping season.

However, these benefits need to be balanced against the drawbacks of greenhouses. The initial capital costs for a greenhouse can be high depending on the degree of technology and sophistication desired. Greenhouses also require additional operating costs because fans are needed to create air circulation to prevent overheating and overly humid conditions. Some

FIGURE 4.19
Small aquaponic units in a greenhouse



FIGURE 4.20
Newly assembled aquaponic units in a greenhouse





diseases and insect pests are more common in greenhouses and need to be managed accordingly (i.e. use of insect nets on doors and windows), although the confined environment can favour the use of certain pest controls.

In some tropical regions, net houses are more appropriate than conventional greenhouses covered with polyethylene plastic or glass (Figure 4.21). This is because the hot climates in the tropics or subtropics raise the need for better ventilation to avoid high temperatures and humidity. Net houses consist of a frame over the grow beds that is covered with mesh netting along the four walls and a plastic roof over the top. The plastic roof is particularly important

to prevent rain from entering, especially in areas with intense rainy seasons, as units could overflow in a matter of days. Net houses are used to remove the threat of many noxious pests associated with the tropics, as well as birds and larger animals. The ideal mesh size for the four walls depends on the local pests. For large insects, the mesh size should be 0.5 mm. For smaller ones, which are often vectors of viral diseases, the mesh size should be thicker (i.e. mesh 50). Net houses can provide some shade if the sunlight is too intense. Common shade materials vary from 25 to 60 percent sunblock.

4.2 ESSENTIAL COMPONENTS OF AN AQUAPONIC UNIT

All aquaponic systems share several common and essential components. These include: a fish tank, a mechanical filter, a biofilter, and hydroponic containers. All systems use energy to circulate water through pipes and plumbing while aerating the water. As introduced above, there are three main designs of the plant growing areas including: grow beds, grow pipes and grow canals. This section discusses the mandatory components, including the fish tanks, mechanical filter, biofilter, plumbing and pumps. The following sections are dedicated to the separate hydroponic techniques, and a comparison is made to determine the most appropriate combination of techniques for different circumstances.

4.2.1 Fish tank

Fish tanks are a crucial component in every unit. As such, fish tanks can account for up to 20 percent of the entire cost of an aquaponic unit. Fish require certain conditions in order to survive and thrive, and therefore the fish tank should be chosen wisely. There are several important aspects to consider, including the shape, material and colour.

Tank shape

Although any shape of fish tank will work, round tanks with flat bottoms are recommended. The round shape allows water to circulate uniformly and transports solid wastes towards the centre of the tank by centripetal force. Square tanks with flat bottoms are perfectly acceptable, but require more active solid-waste removal. Tank shape greatly affects water circulation, and it is quite risky to have a tank with poor circulation. Artistically shaped tanks with non-geometric shapes with many curves and bends can create dead spots in the water with no circulation. These areas can gather wastes and create anoxic, dangerous conditions for the fish. If an odd-shaped tank is to be used, it may be necessary to add water pumps or air pumps to ensure proper circulation and remove the solids. It is important to choose a tank to fit the characteristics of the aquatic species reared because many species of bottom dwelling fish show better growth and less stress with adequate horizontal space.

Material

Either strong inert plastic or fibreglass is recommended because of their durability and long life span. Metal is not possible because of rust. Plastic and fibreglass are convenient to install (also for plumbing) and are fairly light and manoeuvrable. Animal-watering troughs are commonly used, as they tend to be cheap. If using plastic containers, make sure that they are UV-resistant because direct sunlight can destroy plastic. In general, low-density polyethylene (LDPE) tanks are preferable because of their high resistance and food-grade characteristics. Indeed, LDPE is the most commonly used material for water storage tanks for civil uses. Another option is an in-ground pond. Natural ponds are very difficult to manage for aquaponics because the natural biological processes, already occurring within the substrate and mud at the bottom, can be hard to manipulate and the nutrients are often already used by aquatic plants. Cement or plastic-lined ponds are much more acceptable, and can be an inexpensive option. In-ground ponds can make plumbing operations difficult, and the plumbing design should be carefully considered before embarking on this option. One of the simplest fish tanks is a hole dug in the ground, lined with bricks or cinderblocks, and then lined with a waterproof liner such as polyethylene plastic. Other options include second-hand containers, such as bathtubs, barrels or intermediate bulk containers (IBCs). It is very important to make sure the container has not been used previously to store toxic material. Contaminants, such as solvent-borne chemicals, will have penetrated into the porous plastic itself and are impossible to remove with washing. Thus, choose used containers carefully, and know the seller if possible.

Colour

White or other light colours are strongly advised as they allow easier viewing of the fish in order to easily check behaviour and the amount of waste settled at the bottom of the tank (Figures 4.22–4.24). White tanks will also reflect sunlight and keep the water cool. Alternatively, the outside of darker coloured tanks can be painted white. In very hot or cold areas, it may be necessary to further thermally insulate the tanks.

Covers and shading

All fish tanks should be covered. The shade covers prevent algal growth. In addition, the covers prevent fish from jumping out (often occurs with newly added fish or if water quality is sub-optimal), prevent leaves and debris from entering, and prevent predators such as cats and birds from attacking the fish. Often, agricultural shading nets that block 80–90 percent of sunlight are used. The shade cloth can be attached to a simple wooden frame to provide weight and make the cover easy to remove.

Failsafe and redundancy

Do not let the fish tank lose its water; fish will die if the fish tank accidentally drains. Although some accidents are unavoidable (e.g. a tree falling on the tank), most catastrophic fish kills are the result of human error. Ensure that

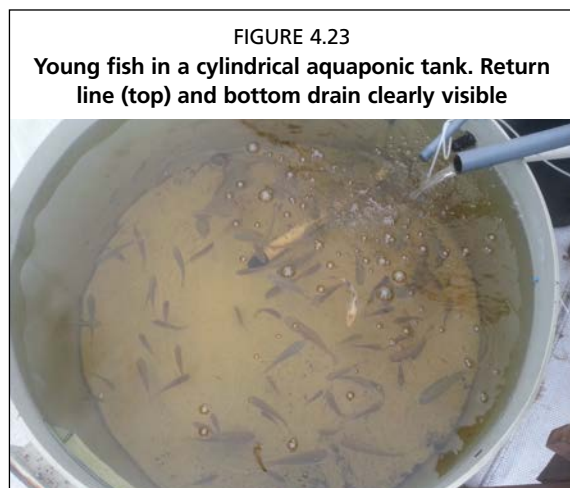
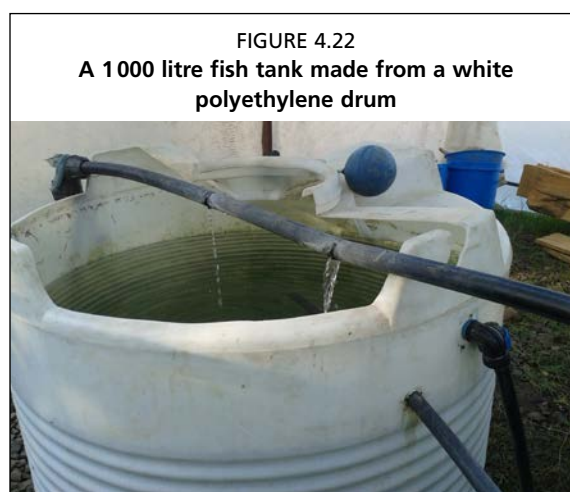



there is no way for the tank to drain without a deliberate choice by the operator. If the water pump is located in the fish tank, be sure to lift the pump off the bottom so that the tank can never be pumped dry. Use a standpipe inside the tank to guarantee a minimum water level. This is discussed further in Section 4.2.6.

4.2.2 Filtration – mechanical and biological

Mechanical filtration

For RASs, mechanical filtration is arguably the **most important** aspect of the design. Mechanical filtration is the separation and removal of solid and suspended fish waste from fish tanks. It is essential to remove these wastes for the health of the system, because harmful gases are released by anaerobic bacteria if solid waste is left to decompose inside the fish tanks. Moreover, the wastes can clog systems and disrupt water flow, causing anoxic conditions to the plant roots. Small-scale aquaponics typically has lower stocking densities than the intensive RAS

methods for which these mechanical filters were originally designed, but some level of mechanical filtration is essential for healthy aquaponic tanks, regardless of the type of hydroponic method used.

There are several types of mechanical filters. The simplest method is a screen or filter located between the fish tank and the grow bed. This screen catches solid wastes, and needs to be rinsed often. Similarly, water leaving the fish tank can pass through a small container of particulate material, separate from the media bed; this container is easier to rinse periodically. These methods are valid for some small-scale aquaponic units, but are insufficient in larger systems with more fish where the amount of solid waste is relevant. There are many types of mechanical filters, including sedimentation tanks, radial-flow clarifiers, sand or bead filters and baffle filters; each of them can be used according to the amount of solid wastes that needs to be removed. However, as this publication focuses on small-scale aquaponics, clarifiers, or mechanical separators, are the most appropriate filters. Clarifiers, in general, can remove up to 60 percent of the total removable solids. For further information on different methods of mechanical filtration, please refer to the further reading section at the end of this publication.

Mechanical separators (clarifiers)

A clarifier is a dedicated vessel that uses the properties of water to separate particles. Generally, water that is moving slower is unable to carry as many particles as water that is flowing faster. Therefore, the clarifier is constructed in such a way as to speed up and slow down the water so that the particles concentrate on the bottom and can be removed. In a swirl clarifier, the water from the fish tank enters near the lower-middle of the clarifier through a pipe. This pipe is positioned tangentially to the container thereby forcing the water to swirl in a circular motion inside the container. The centripetal force created by the circular motion of the water forces the solid waste in the water to the centre and bottom of the container, because the water in the centre of the vortex is slower than that on the outside. Once this waste is collected on the bottom, a pipe attached to the bottom of the container can be periodically opened, allowing the solid waste to flush out of the container. The clarified water exits the

clarifier at the top, through a large slotted outlet pipe covered with a secondary mesh filter, and flows into the biofilter or into the media beds. Figures 4.25–4.27 show examples of simple mechanical separators for small to large units. The solid wastes trapped and removed contain nutrients and are very useful for the systems or for garden plants in general; mineralization of solid waste is discussed in the following section. A general guideline for small-scale units is to size the mechanical separator container to be about one-sixth the volume of the fish tank, but this depends on stocking density and the exact design. Appendix 8 contains detailed, step-by-step instruction on the construction of each part of these systems.

Adequate preliminary mechanical filtration is especially important for NFT and DWC units used to trap and remove solid waste. Without this preliminary process, solid and suspended waste will build up in the grow pipes and canals and will clog the root surfaces. Solid waste accumulation causes blockages in pumps and plumbing components. Finally, unfiltered wastes will also create hazardous anaerobic spots in the system. These anaerobic spots can harbour bacteria that produce hydrogen sulphide, a very toxic and lethal gas for fish, produced from fermentation of solid wastes, which can often be detected as a rotten egg smell.

Biofiltration

Biofiltration is the conversion of ammonia and nitrite into nitrate by living bacteria. Most fish waste is not filterable using a mechanical filter because the waste is dissolved directly in the water, and the size of these particles is too small to be mechanically removed. Therefore, in order to process this microscopic waste an aquaponic system uses microscopic bacteria. Biofiltration is essential in aquaponics because ammonia and nitrite are toxic even at low concentrations, while plants need the nitrates to grow. In an aquaponic unit, the biofilter is a deliberately installed component to house a majority of the living bacteria. Furthermore, the dynamic movement of water within a biofilter will break down very fine solids not captured by the clarifier, which further prevents waste build up on plant roots in NFT and DWC. However, some large aquaponic facilities following the design of the system developed at the University of the Virgin Islands do not use a separate biofilter as they mostly rely on the units' wet surfaces, on plant roots and direct plant uptake to process ammonia. Separate biofiltration is unnecessary in the media bed technique because the grow beds themselves are perfect biofilters.

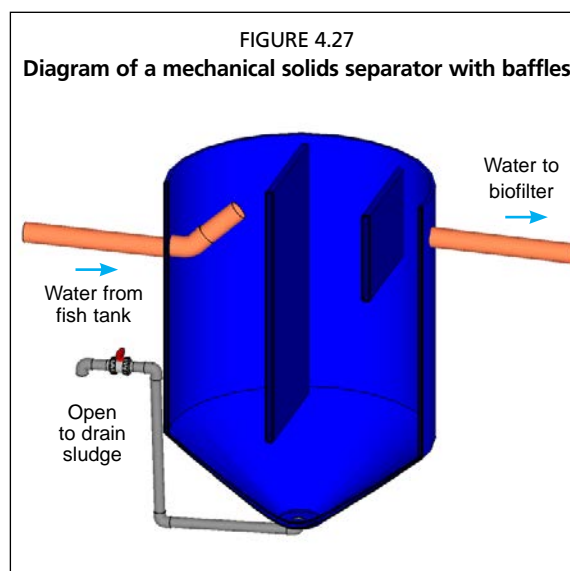
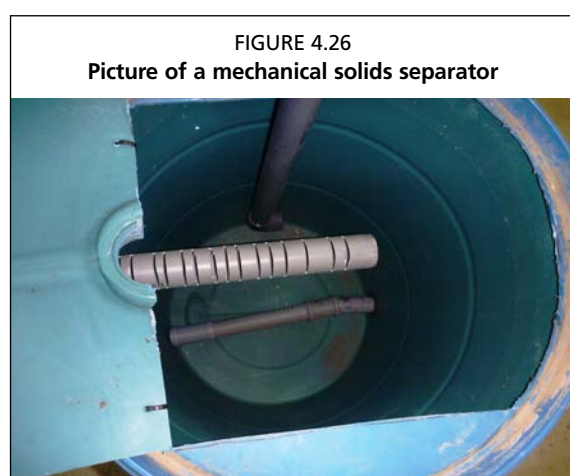
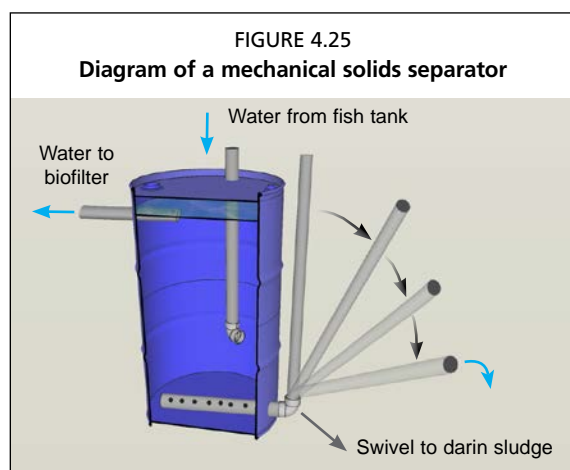

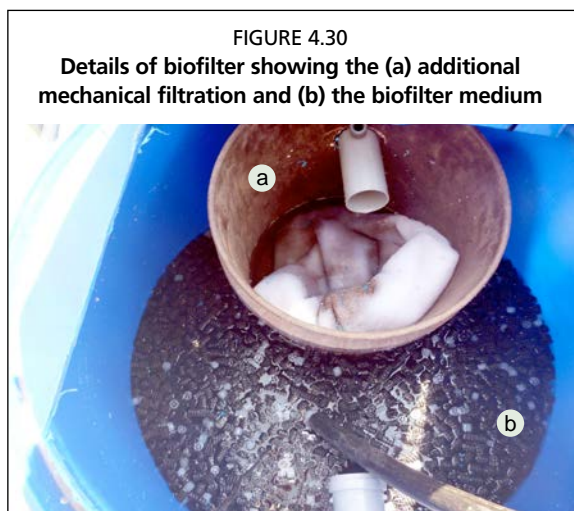
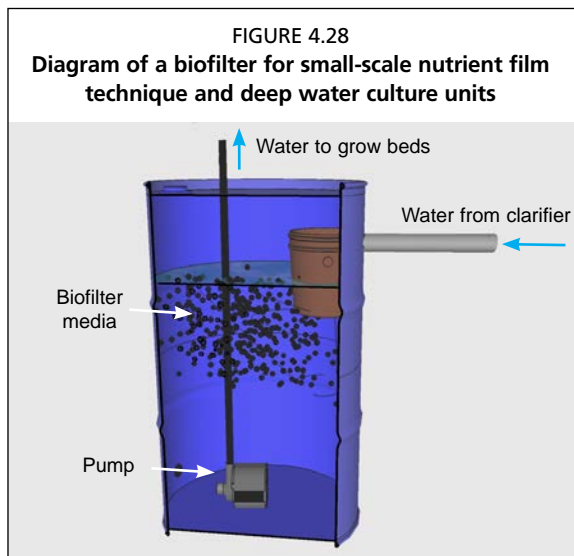

The biofilter is designed to have a large surface area supplied with oxygenated water. The biofilter is installed between the mechanical filter and the hydroponic containers. The minimum volume of this biofilter container should be one-sixth that of the fish tank. Figure 4.28 shows an example of a biofilter for small-scale units.

One commonly used biofilter medium is Bioballs® a proprietary product available from aquaculture supply stores, although similar generic brands exist (Figure 4.29). These are designed to be an ideal biofilter material, because they are small, specially shaped plastic items that have a very large surface area for their volume (500–700 m²/m³). Other media can be used, including volcanic gravel, plastic bottle caps, nylon shower poufs, netting, polyvinyl chloride (PVC) shavings and nylon scrub pads. Any biofilter needs to have a high ratio of surface area to volume, be inert and be easy to rinse. Bioballs® have almost double the surface area to volume ratio of volcanic gravel, and both have a higher ratio than plastic bottle caps. When using suboptimal biofilter material, it is important to fill the biofilter as much as possible, but even so the surface provided by the media may be not sufficient to ensure adequate biofiltration. It is always better to oversize the biofilter during the initial construction, but secondary biofilters can be added later if necessary. Biofilters occasionally need stirring or agitating to prevent clogging, and occasionally need rinsed if the solid waste has clogged them, creating anoxic zones. See Chapter 8 and Appendix 4 for further information on biofiltration size requirements for small-scale units.

Another required component for the biofilter is aeration. Nitrifying bacteria need adequate access to oxygen in order to oxidize the ammonia. One easy solution is to use an air pump, placing the air stones at the bottom of the container. This ensures that the bacteria have constantly high and stable DO concentrations. Air pumps also help break down any solid or suspended waste not captured by the mechanical separator by agitating and constantly moving the floating

Bioballs®. To further trap solids within the biofilter, it is also possible to insert a small cylindrical plastic bucket full of nylon netting (such as Perlon®), sponges or a net bag full of volcanic gravel at the inlet of the biofilter (Figure 4.30). The waste is trapped by this secondary mechanical filter, allowing the remaining water to flow down through small holes drilled at the bottom of the bucket into the biofilter container. The trapped waste is also subject to mineralization and bacterial degradation.

Mineralization

Mineralization, in terms of aquaponics, refers to the way that solid wastes are processed and metabolized by bacteria into nutrients for plants. Solid wastes that are trapped by the mechanical filter contain nutrients; although processing these wastes is different from biofiltration and requires separate consideration. Retaining the solids within the overall system will add more nutrients back to the plants. Any waste that remains on the mechanical filters, within the biofilters or in the grow beds is subjected to some mineralization. Leaving the waste in place for longer allows more mineralization; longer residence time of the waste in the filters will lead to more mineralization and more nutrients being retained in the system. However, this same solid waste, if not properly managed and mineralized, will block water flow, consume oxygen and lead to anoxic conditions, which in turn lead to dangerous hydrogen sulphide gas production and denitrification. Some large systems therefore deliberately leave the solid waste within the filters, ensuring adequate water flow and oxygenation, so that a maximum of the nutrients is released. However, this method is impractical for small-scale NFT and DWC systems. If it is decided to deliberately mineralize these solids, there are simple ways to facilitate the bacterial breakdown in a separate container, simply storing these wastes in this separate container with adequate oxygenation using air stones. After an indefinite amount of time, the solid waste will have been consumed, metabolized and transformed by heterotrophic bacteria. At this point, the water can be decanted and re-added to the aquaponic system, and the remaining waste, which has decreased in volume, can be added to the soil.

Alternatively, these solid wastes can be separated, removed and added to any in-ground agriculture, garden or compost bin as a valuable fertilizer. However, losing these nutrients can cause deficiencies in the plants which may then require supplementation of nutrients (see Chapter 6).

Using a media bed for a combination of mechanical and biological filtration

It is also possible to use a media-filled bed for mechanical and biofiltration in NFT and DWC units (Figures 4.31 and 4.32). This can be important where it is not possible to obtain the materials needed for a swirl separator and/or separate biofilter. Although more fully discussed in Chapter 8, here it is sufficient to say that for every 200 g of fish feed per day the biofilter needs to be 300 litres in volume. This small gravel would provide adequate biofiltration for about 20 kg of fish. Although this media bed would provide adequate biofiltration for an NFT or DWC unit as well as capturing and retaining solid wastes, an additional solids capture device placed into the bed is sometimes recommended in order to prevent the media bed

FIGURE 4.31
Small-scale media bed unit using a screen for additional mechanical filtration



FIGURE 4.32
A media bed unit used for filtration in a deep water culture system



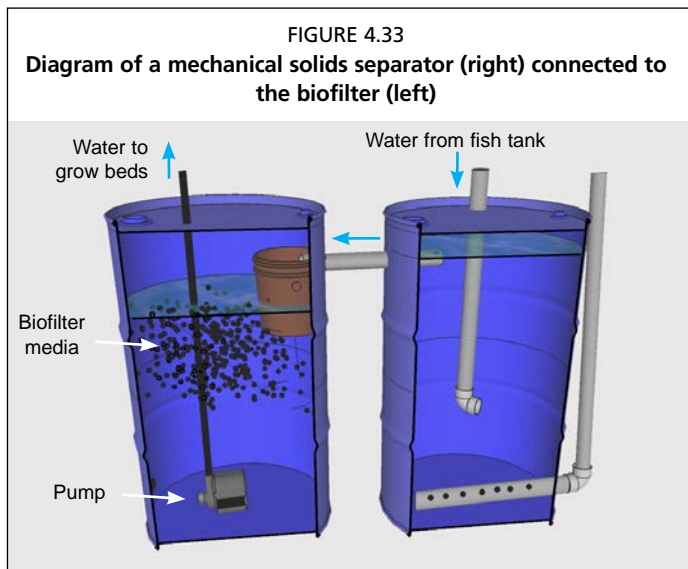

from clogging with fish solids. The bed will need rinsing periodically to remove solid wastes.

In summary, some level of filtration is essential to all aquaponics, although fish stocking density and system design determines how much filtration is necessary. Mechanical filters separate solid wastes to prevent toxic build up, and biofiltration converts dissolved nitrogenous wastes into nitrate (Figures 4.33 and 4.34). The media beds themselves act as both mechanical filters and biofilters when using that technique, but additional mechanical filtration is sometimes necessary for higher fish densities (15 kg/m^3). Without the media beds, such as in NFT and DWC units, standalone filtration is necessary. Mineralization of solid wastes returns more nutrients to the system. Mineralization occurs in media beds, but within NFT and DWC systems separate apparatus are needed.

4.2.3 Hydroponic components – media beds, NFT, DWC

The hydroponic component is the term to describe the plant-growing sections in the unit. There are several designs, three of which are discussed in detail in this publication, but each warrants a separate section. These three designs are: media bed units, sometimes called

particulate beds, where plants grow within a substrate (Figures 4.35 and 4.36); nutrient film technique (NFT) units, where plants grow with their roots in wide pipes supplied with a trickle of culture water (Figure 4.37 and 4.38); and deep water culture (DWC)

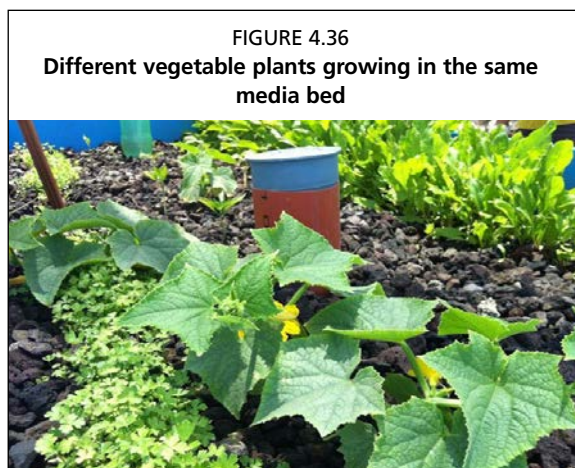

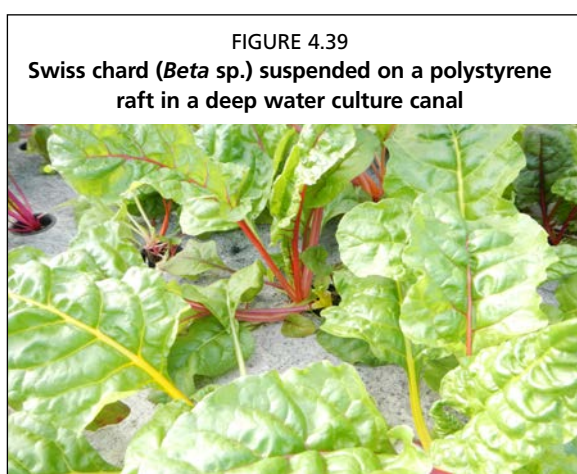
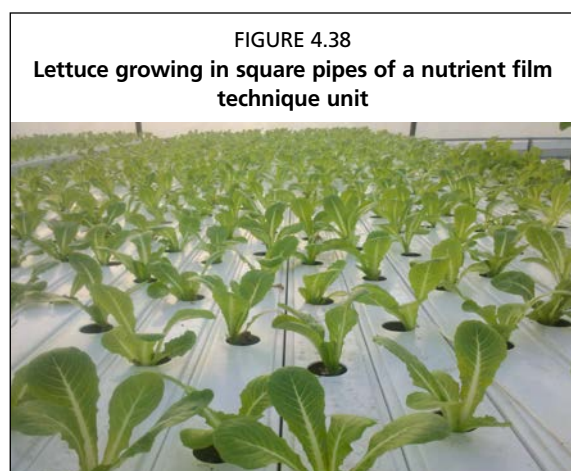
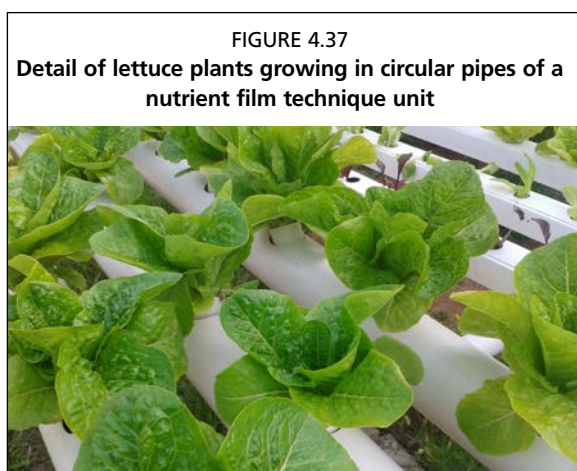

units, also called raft aquaponics or floating bed systems, where plants are suspended above a tank of water using a floating raft (Figure 4.39 and 4.40). Each method has advantages and disadvantages, all with different component styles to suit the needs of each method. See Sections 4.3–4.6 for details of each.

4.2.4 Water movement

Water movement is fundamental for keeping all organisms alive in aquaponics. The flowing water moves from the fish tanks, through the mechanical separator and the biofilter and finally to the plants in their media beds, pipes or canals, removing the dissolved nutrients. If water movement stops, the most immediate effect will be a reduction in DO and accumulation of wastes in the fish tank; without the mechanical filter and biofilter fish can suffer and die within a few hours. Without water flow, the water in media beds or DWC units will stagnate and become anoxic, and NFT systems will dry out.

A commonly cited guideline for densely-stocked aquaponic systems is to cycle the water two times per hour. For example, if an aquaponic unit has a total water volume of 1 000 litres, the water flow rate should be 2 000 litres/h, so that every hour the water is cycled two times. However, at low stocking densities this turnover rate is unnecessary, and the water only needs to be cycled one time per hour. There are three commonly used methods of moving water through a system: submersible impeller pumps, airlifts and human power.

Submersible impeller water pump

Most commonly, an impeller-type submersible water pump is used as the heart of an aquaponics unit, and this type of pump is recommended (Figure 4.41). External pumps

FIGURE 4.41
Submersible water pump, commercially available in many brands, used in small-scale aquaponic units



could be used, but they require further plumbing and are more appropriate for larger designs. High-quality water pumps should preferably be used in order to guarantee a long life span and energy efficiency. Top-quality pumps will maintain their pumping capacity and efficiency for least 1–2 years, with an overall life span of 3–5 years, whereas inferior products will lose their pumping power in a shorter time leading to significantly reduced water flows. Regarding flow rate, the small-scale units described in this publication need a flow rate of 2 000 litres/h at a head height of 1.5 meters; a submersible pump of this capacity would consume 25–50 W/h. A helpful approximation to calculate energy efficiency for submersible pumps is that a pump can move 40 litres of water per hour for every watt per hour consumed, although some models claim twice this efficiency.

When designing the plumbing for the pump, it is important to realize that pumping power is reduced at every pipe fitting; up to 5 percent of the total flow rate can be lost at each pipe connection when water is forced through. Thus, use the minimal number of connections between the pump and the fish tanks. It is also important to note that the smaller the diameter of the pipes, the larger the water flow loss. A 30 mm pipe has twice the flow of a 20 mm pipe even if served from pumps with same capacity. In addition, a larger pipe does not require any maintenance to remove the buildup of solids accumulating inside. In practical terms, this results in significant savings on electricity and operating costs. When installing an aquaponic unit, be sure to place the submersible pump in an accessible location because periodic cleaning is necessary. Indeed, the internal filter will need cleaning every 2–3 weeks. Submersible water pumps will break if they are run without water; never run a pump dry.

FIGURE 4.42
Simple water airlift



Airlift

Airlifts are another technique of lifting water (Figure 4.42). They use an air pump rather a water pump. Air is forced to the bottom of a pipe within the fish tank, bubbles form and burst, and during their rise to the surface the bubbles transport water with them. One benefit is that airlifts can be more electrically efficient, but only at small head heights (30–40 cm). Air lifts gain power in deeper tanks, and are best at a depth greater than one metre. An added value is that airlifts do not clog the way that submersible impeller-type pumps do. In addition, water is also oxygenated through the vertical movement operated by the air bubbles. However, the volume of air pumped should be adequate to move the water along the pipe. Air pumps generally have a longer life than submersible water pumps. The main benefit comes from an economy of scale – a single air pump can be purchased for both aeration and water circulation, which reduces the capital investment in a second pump.

Human power

Some aquaponic systems have been designed to use human power to move water (Figure 4.43). Water can be lifted in buckets or by using pulleys, modified bicycles or other means. A header tank can be filled manually and allowed to slowly drain throughout the course of the day. These methods are only applicable for small systems, and should only be considered where electricity is unavailable or unreliable. Often these systems will have low DO and insufficient mixing of nutrients, although they can be used successfully in conjunction with some modified techniques discussed in Chapter 9.

4.2.5 Aeration

Air pumps inject air into the water through air pipes and air stones that lie inside the water tanks, thereby increasing the DO levels in the water (Figure 4.44). Additional DO is a vital component of NFT and DWC units. Air stones are located at the end of the air line, and serve to diffuse the air into smaller bubbles (Figure 4.45). Small bubbles have more surface area, and therefore release oxygen into water better than large bubbles; this makes the aeration system more efficient and contributes to saving on costs. It is recommended that quality air stones be used in order to obtain the smallest air bubbles. Biofouling will occur, and air stones should be cleaned regularly first with a chlorine solution to kill bacterial deposits and then, if necessary, with a very mild acid to remove mineralization, or replaced, when the flow of bubbles is inconsistent. Quality air pumps are an irreplaceable component of aquaponic systems, and many systems have been saved from catastrophic collapse because of an abundance of DO. If possible, it is preferable to use a combination AC/DC air pump in case of electricity shortages, because when disconnected from AC power during an outage, the charged DC batteries can continue working.

Sizing aeration systems

For small-scale units, with about 1 000 litre fish tanks, it is recommended that at least two air lines, also called injectors, with air stones should be placed in the fish tank, and one injector in the biofilter container. To understand the volume of air entering the system, it is worth measuring the flow rate. To do this, simply invert a volumetric measuring device (a 2 litre bottle, measuring cup, graduated beaker) in the fish tank. With the help of an assistant, begin

FIGURE 4.43
Backyard aquaponic system without the use of a water pump



FIGURE 4.44
Small air pump commercially available in many brands



FIGURE 4.45
Air stone used to diffuse pressurized air into fine bubbles in the water



a stopwatch at the same time as the bubbling air stone is inserted into the measuring device. Stop the stopwatch when the container is full of air. Then, determine the flow rate in litres per minute using a ratio. The target for systems described here is 4–8 litres/min for all of the air stones combined. It is always better to have extra DO rather than not enough.

Try to place air stones so that they do not re-suspend settling solids, thus preventing their removal through the centre drain.

Venturi siphons

Low-tech and simple to construct, Venturi siphons are another technique to increase the DO levels in aquaponics. This technique is especially valuable in DWC canals. Simply speaking, Venturi siphons use a hydrodynamic principle that pulls in air from the outside (aspiration) when pressurized water flows with a faster speed through a pipe section of a smaller diameter. With constant water flow, if the pipe diameter diminishes the water velocity must increase, and this faster speed creates a negative pressure. Venturi siphons are short sections of pipe (20 mm diameter, 5 cm length) inserted inside the main water pipe of a larger diameter (25 mm). As the water in the main pipe is forced through the narrower section, it creates a jet effect (Figure 4.46). This jet effect sucks surrounding air into the water stream through a small hole cut into the outer constriction pipe. If the Venturi siphon is underwater, the small hole can be connected to a length of tubing that is exposed to the atmosphere. Venturi siphons can be integrated into each inflow pipe in DWC canals, which will raise the DO content of the canal. They can also serve as a redundancy for fish tank aeration if the air pump fails. See the section Further Reading for more sources of information.

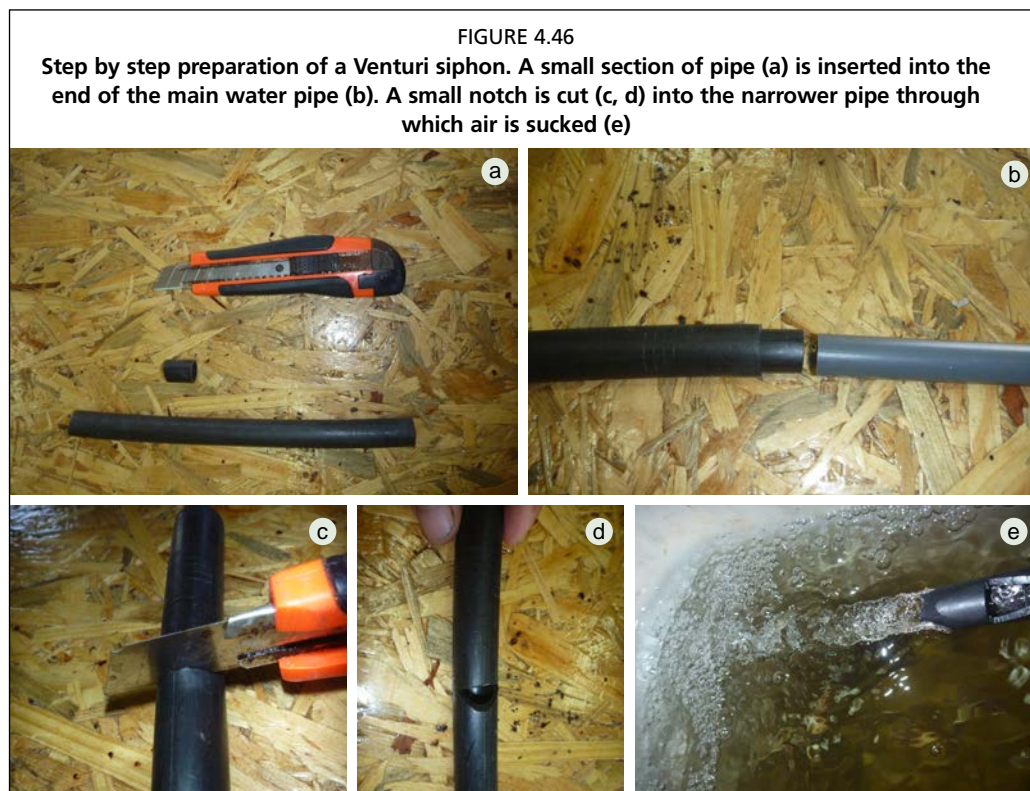

4.2.6 Sump tank

The sump tank is a water collection tank at the lowest point in the system; water always runs downhill to the sump (Figure 4.47). This is often the location of the submersible pump. Sump tanks should be smaller than the fish tanks, and should be able to hold

between one-fourth and one-third of the volume of the fish tank. For ebb-and-flow type media beds, the sump needs to be large enough to hold at least the entire volume of water in the grow beds (see Section 4.3). External sump tanks are mainly used in media bed units; however, for DWC units the actual hydroponic canal can be used as a sump tank / pump house also. Although helpful, it is not an essential system component, and many designs do not employ an external sump tank. Very small units, with fish tanks up to 200 litres can simply pump water from the fish tank to the grow beds, from where water trickles back down into the fish tank. However, for larger units it is very useful to have a sump.

A common method of aquaponics, and the one recommended here, is to have the pump located in the sump tank. A commonly used acronym describes the key points of this design, which is: constant height in fish tank – pump in sump tank (CHIFT-PIST). Using this method means that any water losses, including both evaporation and leaking components, are only manifested within the sump tank and do not affect the volume of the fish tank. It is then straight-forward to measure the normal evaporative losses and to calculate how often water needs replenishing, and it can be determined immediately if there is a leak. Perhaps more importantly, any leaks in the hydroponic system will not harm the fish. Section 9.2 discusses securing water levels in different ways.

4.2.7 Plumbing materials

Every system requires a selection of PVC pipe, PVC connections and fittings, hoses and tubes (Figure 4.48). These provide the channels for water to flow into each component. Bulkhead valves, Uniseals® (hereafter uniseal), silicone sealant and Teflon tape are also needed. The PVC components are connected together in a permanent way using PVC cement, although silicone sealant can be temporarily used if the plumbing is not permanent and the joints are not under high water pressure. In addition, some general tools are needed such as hammers, drills, hand saws, electric saws, measuring tapes, pliers, channel-locking pliers, screwdrivers, levels, etc. One special tool is a hole-saw and/or spade bit, which are used in an electric drill to make holes up to 8 cm, necessary for inserting the pipes into the fish tanks and filters, as well as for making holes in the PVC or polystyrene grow beds in NFT and DWC systems. Appendix 8 contains a detailed list of materials needed for each unit described in this publication.

Make sure that the pipes and plumbing used in the system have never previously been used to hold toxic substances. It is also important that the plumbing used is of food-grade quality to prevent possible leeching of chemicals into the system water. It is also important to use pipes that are black and/or non-transparent to light, which will stop algae from growing.

FIGURE 4.47
Sump tank buried in the ground to allow water collection by gravity



FIGURE 4.48
A selection of commonly used plumbing materials



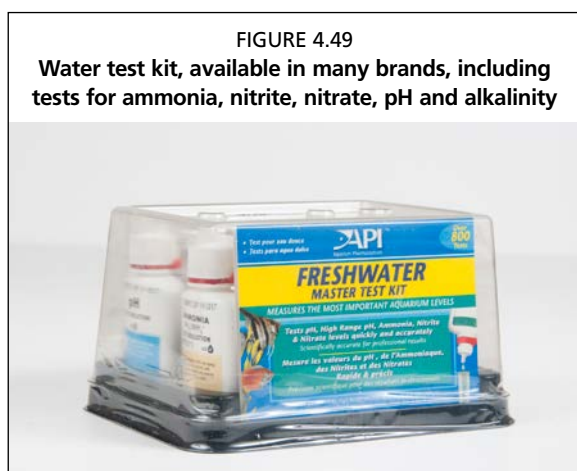

4.2.8 Water testing kits

Simple water tests are a requirement for every aquaponic unit. Colour-coded freshwater test kits are readily available, fairly economical and easy to use, and thus these are recommended. These can be purchased in aquarium stores or online. These kits include tests for pH, ammonia, nitrite, nitrate, GH and KH (Figure 4.49). Be sure that the manufacturers are reliable and that the expiration date is still valid. Other methods include digital meters or test strips. If using digital meters for pH or nitrate, be sure to calibrate the units according to the manufacturer's directions. A thermometer is necessary to measure water

temperature. In addition, if there is risk of saltwater in the source water, a cheap hydrometer, or a more accurate but more expensive refractometer, is worthwhile. More details on the use of colourimetric test kits are included in Section 3.3.6.

4.3 THE MEDIA BED TECHNIQUE

Media-filled bed units are the most popular design for small-scale aquaponics. This method is strongly recommended for most developing regions. These designs are efficient with space, have a relatively low initial cost and are suitable for beginners because of their simplicity. In media bed units, the medium is used to support the roots of the plants and also the same medium functions as a filter, both mechanical and biological. This double function is the main reason why media bed units are the simplest; the following sections demonstrate how NFT and DWC methods both require isolated and more complicated components for filtration. However, the media bed technique can become unwieldy and relatively expensive at a larger-scale. Media can become clogged if fish stocking densities exceed the beds' carrying capacity, and this can require separate filtration. Water evaporation is higher in media beds with more surface area exposed to the sun. Some media are very heavy.

There are many designs for media beds, and this is probably the most adaptable technique. For example, *Bumina* is an aquaponic technique used in Indonesia that uses many small media beds connected to an in-ground fish tank (Section 9.4.3). Moreover, recycled materials can easily be repurposed to hold the media and the fish.

4.3.1 Water flow dynamics

Figure 4.50 shows the main components of an aquaponic system using media beds, including the fish tank, the media beds, the sump tank and water pump, as well as concrete blocks for support. It is easiest to understand by following the water flow through the system. Water flows by gravity from the fish tank, through a simple mechanical filter and into the media beds. These media beds are full of porous biofilter media that serves as both the mechanical and biological filter and location for mineralization. These beds both host the colony of nitrifying bacteria as well as provide the place for the plants to grow. On exiting the media beds, the water travels down to the sump tank, again by gravity. At this point, the water is relatively free of solid and dissolved wastes. Finally, this clean water is pumped back to the fish tank, which causes the water level to rise and over-flow from the fish tank back into the media beds, completing the cycle. Some media beds are designed to flood-and-drain, which means that the water level rises to a certain point and then completely drains. This adds oxygen to the plant roots and aids in the biofiltration of the ammonia. Other media irrigation methods use a constant flow of water, either entering one side of the bed and exiting the other, or distributed through a drip irrigation array.

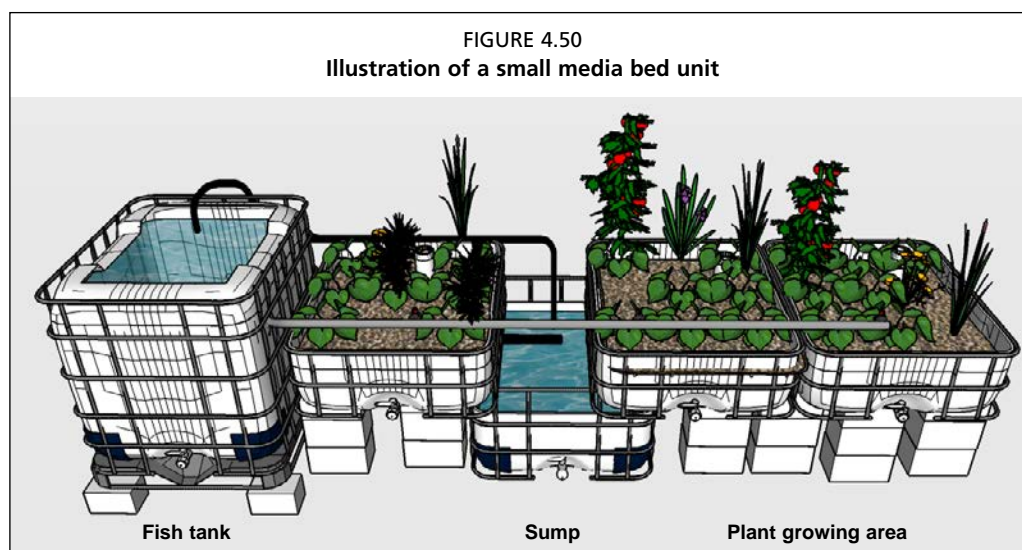

4.3.2 Media bed construction

Materials

Media beds can be made from plastic, fibreglass or a wooden frame with water-tight rubber or polyethylene sheeting on the base and inside the walls. The most popular “do-it-yourself” (DIY) media beds are made from plastic containers, modified IBCs or even old bathtubs (Figure 4.51). It is possible to use all of the above as beds and other kinds of tanks so long as they meet these following requirements:

- strong enough to hold water and growing media without breaking;
- able to withstand difficult weather conditions;
- made of food-grade material that is safe for the fish, plants and bacteria;
- can be easily connected to other unit components through simple plumbing parts; and
- can be placed in close proximity to the other unit components.

Shape

The standard shape for media beds is a rectangle, with a width of about 1 m and a length of 1–3 m. Larger beds can be used / manufactured, but they require additional support (i.e. concrete blocks) in order to hold their weight. In addition, longer beds may have unequal distributions of solids that tend to accumulate at the water inlet, raising the risk of anaerobic spots. The beds should not be so wide that the farmer/operator is unable to reach across, at least half-way.

Depth

Media bed depth is important because it controls the amount of root space volume in the unit which determines the types of vegetables that can be grown. If growing large fruiting vegetables such as tomatoes, okra or cabbage, the media bed should have a depth of 30 cm, without which the larger vegetables would not have sufficient root space, would experience root matting and nutrient deficiencies, and would probably topple

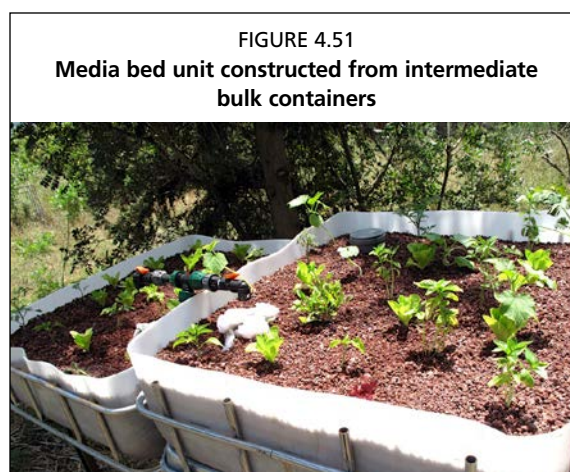



over (Figure 4.52). Small leafy green vegetables only require 15–20 cm of media depth, making them a good choice if the media bed size is limited. Even so, some experiments have shown that even the larger crops can be grown in shallow beds if the nutrient concentrations are sufficient.

4.3.3 Choice of medium

All applicable growing media will have several common and essential criteria. The medium needs to have adequate surface area while remaining permeable for water and air, thus allowing the bacteria to grow, the water to flow and the plants roots to breathe. The medium

must be inert, not dusty, and non-toxic, and it must have a neutral pH so as not to affect the water quality. It is important to wash the medium thoroughly before placing it into the beds, particularly volcanic gravel which contains dust and tiny particles. These particles can clog the system and potentially harm the fishes' gills. Finally, it is important to work with material that is comfortable for the farmer. These essential criteria are listed below:

- large surface area for bacterial growth;
- neutral pH and inert (meaning the medium will not leach out any potentially toxic substances);
- good drainage properties;
- easy to work with;
- sufficient space for air and water to flow within the medium;
- available and cost-effective; and
- light-weight, if possible.

Several common media meeting the criteria are discussed include:

Volcanic gravel (tuff)

Volcanic gravel is the most popular medium to use for media bed units and is recommended where available (Figure 4.53). The three best qualities of volcanic gravel are that it has a very high surface area to volume ratio, it can be cheap and easy to obtain, and it is almost chemically inert. Volcanic gravel has a surface area to volume



ratio of about 300 m²/m³, depending on the particle size, which provides ample space for bacteria to colonize. Volcanic gravel is abundant in many locations around the world. Once washed of dust and dirt, volcanic gravel is almost completely chemically inert, except for small releases of microelements such as iron and magnesium and the absorption of phosphate and potassium ions within the first few months of starting a unit. The recommended size of volcanic gravel is 8–20 mm in diameter. Smaller gravel is likely to clog with solid waste and larger gravel does not offer the surface area or plant support as required.

Limestone

Limestone is not recommended as a growing medium, though it is commonly used (Figure 4.54). Limestone, a sedimentary rock, is less desirable than other media because it has a lower surface area to volume ratio, is heavy and is not inert. Limestone is composed primarily of calcium carbonate (CaCO_3), which dissolves in water and affects water quality. Limestone will increase the KH of the water, which will also increase the pH (see Section 3.3). Therefore, this material is better used where water sources are very low in alkalinity or acidic, as in cases of alkaline water it would call for constant acid corrections of incoming waters. Nevertheless, a small addition of limestone can help to counterbalance the acidifying effect of nitrifying bacteria, which can offset the need for regular water buffering in well balanced systems. Limestone may not be as comfortable to work with in terms of planting and harvesting, and it can experience clogging if the proper granulometry is not chosen. However, it is often the cheapest and most common form of gravel available. Limestone is only acceptable as a medium if no other media are available, but be aware of its impact on water quality.



Light expanded clay aggregate

Light expanded clay aggregate (LECA) consists of expanded clay pebbles (Figure 4.55). Originally, it was manufactured for thermal insulation of building roofs, but it has more recently been used in hydroponics. These pebbles are round in shape and very lightweight compared with other substrates. They are very comfortable to work with and ideal for rooftop production. The surface area of LECA is about $250\text{--}300\text{ m}^2/\text{m}^3$, which is within the target range. However, LECA is relatively expensive and not widely available around the world. It comes in a variety of sizes; for aquaponics the larger sizes with diameters $8\text{--}20\text{ mm}$ are recommended. This material can give additional benefits to growers in case of media beds placed directly on rooftop floors (depending on design). The building can in fact benefit from additional insulation, which can decrease houses' cooling/heating costs.



Other possible media choices

If the above-listed media are unavailable, it is possible to use other media. Alternatives include: river-bed gravel, which is usually limestone but can have a low surface area to volume ratio depending on the granulometry; pumice (also rockwool), a white/grey volcanic material also popularly used as growing medium in hydroponics; recycled plastic, although plastic floats and needs to be held submerged with a layer of gravel on top; or organic substrates such as coconut fibre, sawdust, peat moss or rice hull, which are often inexpensive but risk becoming anoxic, deteriorating over time and clogging the system. However, organic substrate can be used for a time within aquaponics, and once it begins to deteriorate, the media can be removed from the system, composted, and used as a valuable soil addition for soil crops. Table 4.1 summarizes the major characteristics for all the growing media mentioned above.

TABLE 4.1
Characteristics of different growing media

Media type	Surface area (m ² /m ³)	pH	Cost	Weight	Lifespan	Water retention	Plant support	Ease to work with
Volcanic gravel (tuff)	300–400	Neutral	Medium	Medium	Long	Medium–Poor	Excellent	Medium
Volcanic gravel (pumice)	200–300	Neutral	Medium–High	Light	Long	Medium	Medium–Poor	Easy
Limestone gravel	150–200	Basic	Low	Heavy	Long	Poor	Excellent	Difficult
Expanded clay (LECA)	250–300	Neutral	High	Light	Long	Medium–Poor	Medium	Easy
Plastic bottle caps	50–100	Inert	Low	Light	Long	Poor	Poor	Easy
Coconut fibre	200–400 (variable)	Neutral	Low–Medium	Light	Short	High	Medium	Easy

Displacement of water by media

Depending on the medium, it will occupy roughly 30–60 percent of the total media bed volume. This percentage will help decide on the sump tank size for each unit, because the sump tank, at the very least, will need to hold the total water volume contained in all the media beds. Sump tanks should be slightly oversized to ensure that there is always adequate water for the pump to run without ever running dry.

For example, for a media bed of 1 000 litres (dimensions 2 m long × 2 m wide × 0.25 m medium depth), the growing medium will displace 300–600 litres of this space, and therefore the water volume of the media bed would be 400–700 litres. It is recommended that the sump volume be at least 70 percent of the total media bed volume. For this example, the sump tank should be approximately 700 litres.

4.3.4 Filtration

The media beds serve as very efficient filters, both mechanical and biological. Unlike the NFT and DWC systems (discussed below), the media bed technique utilizes a combination filter and plant growing area. In addition, the media bed provides a place for mineralization to occur, which is absent in the NFT and DWC systems. However, at high stocking densities (>15 kg/m³), the mechanical filtration can be overwhelmed and can face the risk of having the media clogged and producing dangerous anaerobic spots.

Mechanical filter

The medium-filled bed functions as a large physical filter, capturing and containing the solid and suspended fish waste and other floating organic debris. The effectiveness of this filter will depend on the particle size of the medium because smaller particles are more densely packed and capture more solids. Moreover, a high water flow rate can force particles through the media bed and escape the filter. Over time, the captured solid wastes will break down and be mineralized. A properly balanced system will process all of the incoming solid wastes.

When media beds are improperly sized for the stocking density, the media bed can become clogged with solids. This indicates a mistake in the original design when the feed rate ratio was used to balance the system. This situation leads to beds clogged with solid waste, poor water circulation, anoxic areas and dangerous conditions. When this occurs, the medium needs to be washed, which is labour-intensive, disrupts the plant growing cycle and can briefly disturb the nitrifying bacteria.

To avoid this situation be sure that the original design considered the stocking density, feeding regime, and used the feed rate ratio to calculate the required area of the media bed. Alternatively, another solids capture device can be integrated into the

unit design. This is also recommended where the stocking density exceeds 15 kg/m³ and/or if the feeding rate is above 50 g/day for each square metre of grow bed. There are several options for this additional mechanical filter. A rudimentary and cheap technique is to affix an old, orphan sock to the tap where water from the fish tank enters the media bed. This simple filter can be removed each day and rinsed. Another more elaborate method is to place a 3–5 litre bucket inside the media bed with several small holes (6–8 mm) drilled into the side surfaces (Figure 4.31). Sponges, nylon netting or even growing media (volcanic gravel, LECA) can be tied in a porous inert net bag and placed into this bucket. This filter will trap the solid waste, and the filter can then be removed periodically to be rinsed and replaced.

Biological filtration

All of the growing media herein outlined have a large surface area where nitrifying bacteria can colonize. Of all of the aquaponic designs, media beds have the most biological filtration because of the huge area of media on which the bacteria can grow. Biofiltration capacity can be limited or lost if the media beds become anoxic, if the temperatures drop or if the water quality is poor, but generally media beds have more than adequate biological filtration.

Mineralization

Over time, the solid and suspended fish waste and all other debris are slowly broken down by biological and physical processes into simple nutrients in the form of simple molecules and ions that the plants can easily absorb. If sludge accumulates in the media bed and does not leave, it may indicate that the mineralization process is not sufficient. In this case, the recommendation is to use more effective mechanical filtration and process the filtered waste separately. This process is described in more detail in Section 4.2.2 and Chapter 5.

4.3.5 The three zones of media beds – characteristics and processes

The nature of a flood-and-drain media bed creates three separate zones that can be considered microecosystems, which are differentiated by their water and oxygen content. Each zone hosts a diverse group of bacteria, fungi, micro-organisms, worms, insects and crustaceans. One of the most important is the nitrifying bacteria used for biofiltration, but there are many other species that all have a role in the breaking down of fish wastes. It is not essential to be aware of all these organisms, but this section briefly outlines the differences between these three zones and some of the ecological processes occurring in each.

Dry zone

The top 2–5 cm of the bed is the dry zone (Figure 4.56). This zone functions as a light barrier, preventing the light from hitting the water directly which can lead to algal growth. It also prevents the growth of fungus and harmful bacteria at the base of the plant stem, which can cause collar rot and other plant diseases. Another reason to have a dry zone is to minimize evaporation from beds by covering the wet zone from direct light. Moreover, beneficial bacteria are sensitive to direct sunlight.

Dry/wet zone

This is the zone that has both moisture and high gas exchange. In flood-and-drain techniques (discussed below) this is the 10–20 cm space where the media bed intermittently floods and drains (Figure 4.57). If not using flood-and-drain techniques, this zone will be the path that the water flows through the medium. Most of the biological activity will occur in this zone. The root development, the beneficial bacteria colonies and beneficial micro-organisms are active in this zone. The plants and the

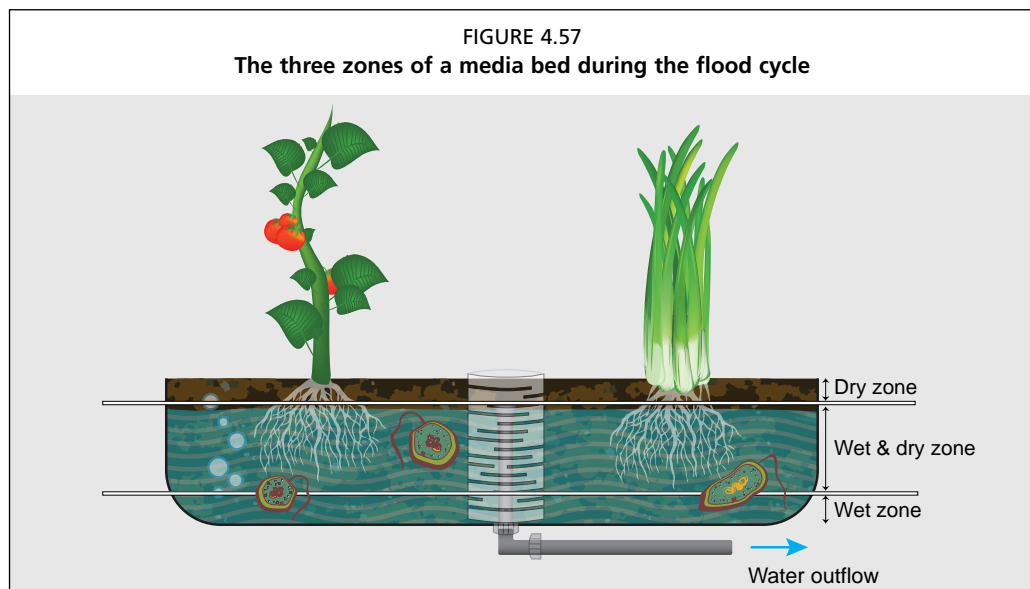
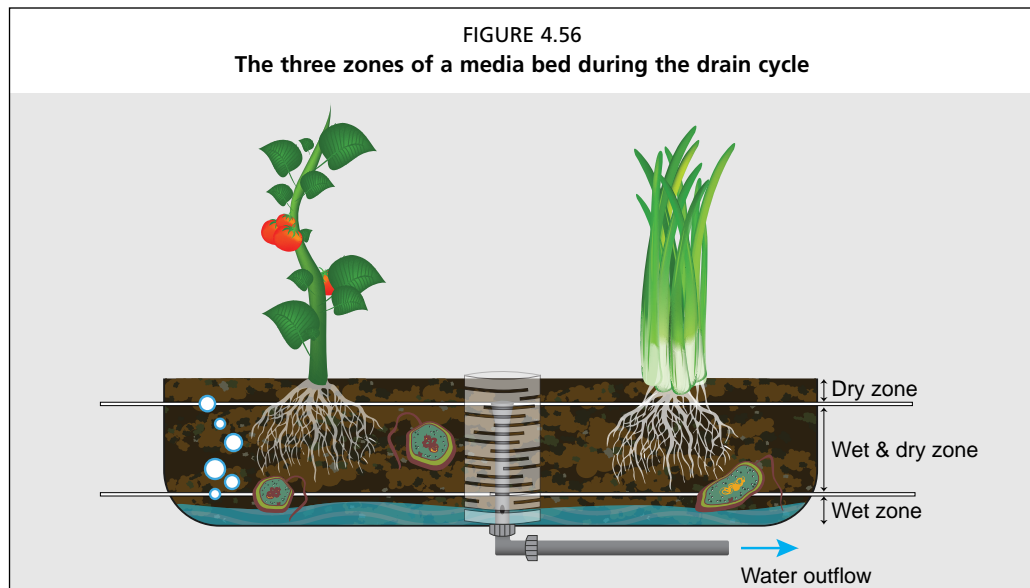

animals receive their water, nutrients and oxygen because of the interface between air and water.

One common technique is adding worms to the media bed which will live in this dry/wet zone. The worms will contribute to the breakdown of solid fish waste and they will also consume any dead leaves or roots. This activity will prevent wastes from clogging the system. See Section 9.1.1 for more information about worms and vermicompost.

Wet zone

This zone, the bottom 3–5 cm of the bed, remains permanently wet. In this zone, the small particulate solid wastes accumulate, and, therefore the organisms that are most active in mineralization are located here. These include heterotrophic bacteria and other micro-organisms. These organisms are responsible for breaking down the waste into smaller fractions and molecules that can be absorbed by the plants through the process of mineralization.

4.3.6 Irrigating media beds

There are different techniques to deliver water to media beds, each can be relevant depending on the local availability of materials, the degree of technology desired or the experience of the operators. Water can be simply trickled from holed pipes uniformly distributed on the medium; this is a perfectly acceptable design. Some experts have demonstrated that constant flow designs, where the water level within the grow bed is always the same, support the same growth rates of plants as more complicated methods. These water distribution systems can become clogged with solid fish waste and should be periodically cleared.

A method called flood-and-drain, also known as ebb-and-flow, can be used where the system of plumbing causes the media beds to flood with water from the fish tank and then drain back in the sump tank. This is accomplished through autosiphons or timed pumping. This alternation between flooding and draining ensures that the plants have both fresh nutrients and adequate air flow in the root zone. This thereby replenishes the oxygen levels for plants and bacteria. It also ensures that enough moisture is in the bed at all times so the bacteria can thrive in their optimum conditions. Usually, these systems go through the complete cycle 1–2 times every hour, but some successful systems only cycle 3–4 times per day. Flood-and-drain designs are not the only techniques for media beds, and managing the water flow cycle may be frustrating and time-consuming for novice operators.

This publication briefly discusses two popular methods for flooding and draining a bed, although other methods, such as the looped siphon, exist and are the subject of current research.

Bell siphon

The bell siphon is a type of autosiphon that exploits a few physical laws of hydrodynamics and allows the media bed to flood and drain automatically, periodically, without a timer (Figure 4.58). The action, timing and ultimate success of the siphon are dependent on the water's flow rate into the bed, which is constant. Bell siphons can nevertheless be finicky and require attention.

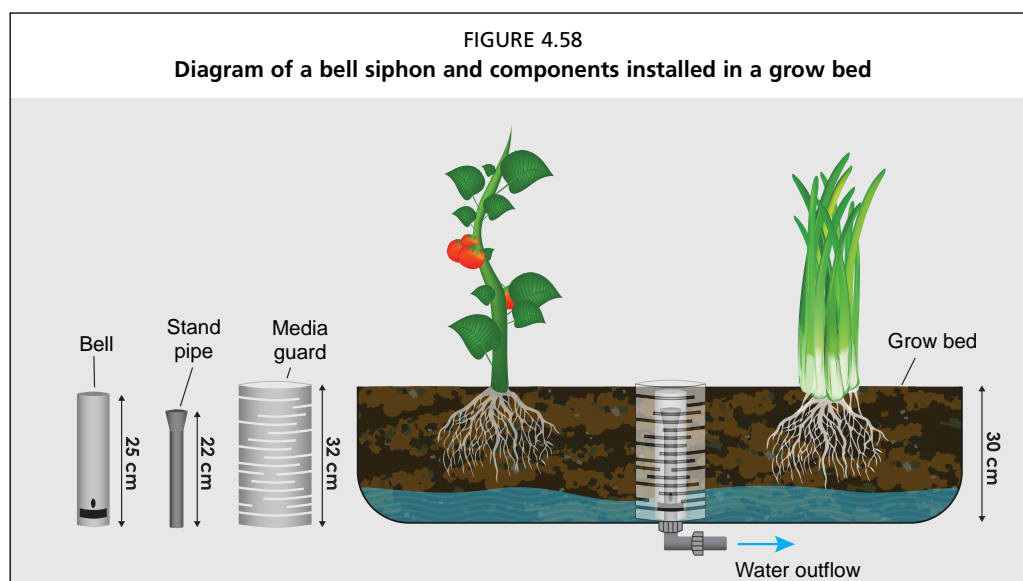

Water flow dynamics

Water flows into each grow bed at a constant flow rate. As the water fills the grow bed it reaches the top of the standpipe, and begins to drip through the standpipe back to the sump tank. Without the bell portion of the bell siphon, this would create a condition

of constant water height. Instead, as the water continues to fall through the standpipe, the bell, which sits over the standpipe something like a hat, acts as an air tight lock and produces a siphon effect. This suction within the bell starts the siphon. Once started, all the water from the bed starts to rapidly flush down the standpipe as the bell keeps its air tight seal. The draining through the standpipe is faster than the constant inflow from the fish tank. When the water in the grow bed drains all the way down to bottom, air enters the bottom of the bell and immediately stops the siphon. The water then slowly fills back up and repeats the whole cycle again continuously. See the section on Further Reading at the end of this publication for more information on bell siphons.

Main components of a bell siphon

The three main components of a bell siphon are described below. Note that detailed instructions for understanding, constructing and optimizing bell siphons, as well as pictures of these components, can be found in Appendix 8. The dimensions of the standpipe, bell and media guard are completely dependent on the size of the grow bed and incoming water flow rate. These dimensions are provided for the aquaponic designs outlined in this publication for a media bed of 1–3 m² with a media depth of 30 cm, with an incoming water flow rate of 200–500 litres/h for each bed. For large grow beds, all of the components would be larger.

Standpipe – The standpipe is constructed of a PVC pipe, 2.5 cm diameter, of a height of 22 cm. The standpipe passes through the bottom of the grow bed, connecting to the sump, and is the path of the water as it drains.

Bell – The bell is a PVC pipe, 7.5 cm diameter, of a height of 25 cm. The pipe is capped with a PVC end-cap on top, and is open on the bottom where it fits over the standpipe. Two rectangular gaps, 1 cm × 4 cm, are located near the bottom of the bell, 1.5 cm up on opposite sides, through which the water is pulled up into the standpipe inside the bell. A final 1 cm hole is drilled 5 cm from the bottom to help break the siphon once the grow bed is drained by allowing air to enter.

Media guard – The media guard is a PVC pipe, 11 cm diameter, of a height of 32 cm with many small holes drilled in its sides. The media guard prevents the gravel from the grow bed from entering and clogging the standpipe, without obstructing the flow of water.

Timer mechanism

This method of flood-and-drain irrigation relies on a timer switch on the water pump to control the periodic flooding and draining (Figure 4.59). The benefit of this method

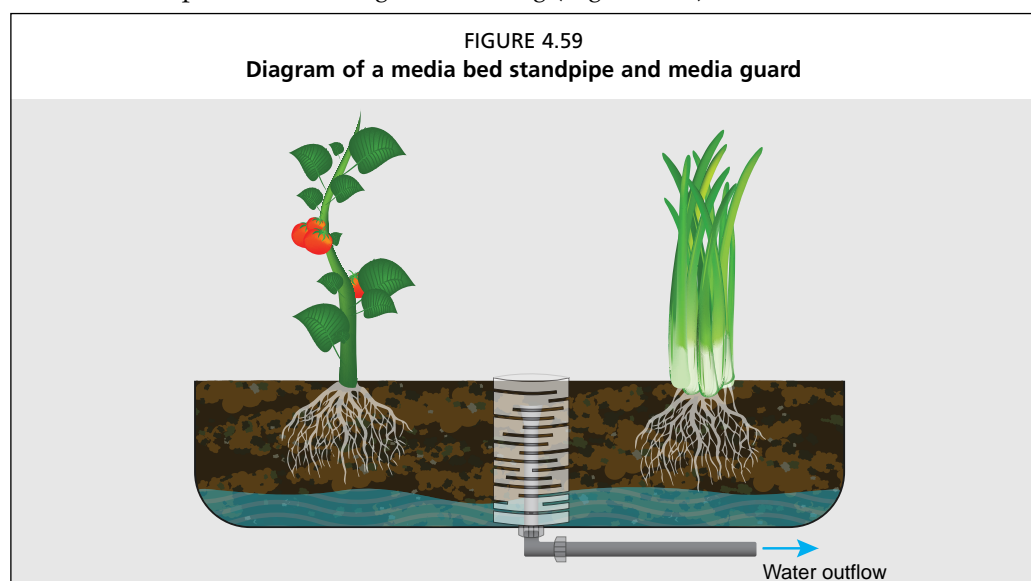

is that there is no autosiphon, which can be labour-intensive to calibrate. However, the reduced water circulation and reduced aeration in the fish tanks results in less overall filtration. This method is less appropriate in high-density stocking situations, and requires careful attention to provide supplemental aeration to fish.

Water flow dynamics

Water flows into the grow bed, flooding the bed until the water reaches the top of the standpipe. The water then drains through this standpipe and down into the sump tank. The large standpipe is of sufficient diameter to drain all of the inflowing water; the top of the large standpipe is the deepest flood that the grow bed will experience. There is also a small inlet, 6–12 mm diameter, into this same standpipe located near the bottom. This small inlet is insufficient to drain all of the incoming water and, therefore, even as water enters the small inlet, the grow bed continues to flood until it reaches the top. At some point after the bed is full, the timer cuts the power to the water pump. Water in the media bed begins to flow out through the small inlet hole, continuing to drain the grow bed until the water reaches the level of the bottom hole. At this point, the power is returned to the water pump and the grow bed is refilled with fresh fish-tank water. It is very important that the water flowing into the media bed is greater than the water flowing through the small inlet in the standpipe so that the bed will fully flood again. The flooding and draining cycle length and the diameter of the dripping hole are determined by the size of the media bed and the incoming flow rate.

To ensure adequate filtration, the entire fish tank volume should be pumped through the grow beds every hour. Finally, make sure to flush the beds out once every week by temporarily removing the standpipe and allowing the remaining water to drain.

The materials involved for the timer method for the aquaponic designs included in this publication are as follows: a standpipe, 2.5 cm diameter, of a height of 23 cm that has a secondary dripping hole, 6–12 mm diameter, 2.5 cm above the bottom; a media guard, 11 cm diameter and 32 cm in height, encircling the standpipe to prevent media from clogging it; and a timer that controls the pump that is calibrated based on the flow rate of the pump and the drain rate of the standpipe.

4.4 NUTRIENT FILM TECHNIQUE (NFT)

The NFT is a hydroponic method using horizontal pipes each with a shallow stream of nutrient-rich aquaponic water flowing through it (Figure 4.60). Plants are placed within holes in the top of the pipes, and are able to use this thin film of nutrient-rich water.

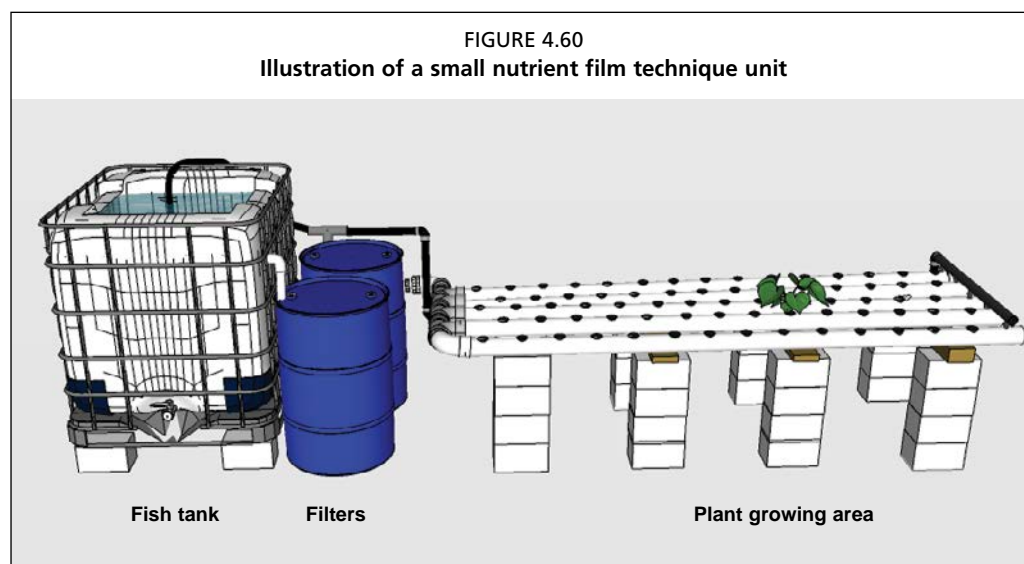



Both the NFT and DWC are popular methods for commercial operations as both are financially more viable than media bed units when scaled up (Figure 4.61). This technique has very low evaporation because the water is completely shielded from the sun. This technique is far more complicated and expensive than media beds, and may not be appropriate in locations with inadequate access to suppliers. This technique is most useful in urban applications, especially when using vertical space or weight-limitations are considerations.

Although all methods have a different approach to actually growing plants, the most important difference between them is the method

of filtration that both the NFT and DWC units utilize compared with the media bed method. The following text describes this method of filtration for NFT and DWC units in detail. Afterwards, the NFT and DWC methods are discussed individually. The general layout of this section begins with water flow dynamics, or how the water moves through the system. Then filtration methods are discussed, followed by specific planting guidelines for NFT systems.

4.4.1 Water flow dynamics

The water flows by gravity from the fish tank, through the mechanical filter and into the combination biofilter/sump. From the sump, the water is pumped in two directions through a “Y” connector and valves. Some water is pumped directly back to the fish tank. The remaining water is pumped into a manifold that distributes the water equally through the NFT pipes. The water flows, again by gravity, down through the grow pipes where the plants are located. On exiting the grow pipes, the water is returned to the biofilter/sump, where again it is pumped either into the fish tank or grow pipes. The water that enters the fish tank causes the fish tank to overflow through the exit pipe and back into mechanical filter, thus completing the cycle.

This design, as described in this publication, is called a “*Figure 8*” design because of the path of the water. This design ensures that filtered water enters both the fish tank and the grow pipes, while only using one pump. There is no need to place the sump lower than the rest of the unit, making this design possible to use on existing concrete floors or on rooftops. All components are at a comfortable working level for the farmer without stooping or using ladders. Moreover, the design fully utilizes the size of the IBC container to ensure adequate room for the fish. One drawback is that the combination sump/biofilter works to dilute the nutrient concentration of the water reaching the grow pipes, and at the same time, returns water to the fish before the water has been fully stripped of nutrients. However, the slight dilution is managed by controlling the bidirectional flow leaving the sump/biofilter and, overall, it has little effect on the efficacy of this system in light of the benefits provided. Generally, the pump returns 80 percent of the water to the fish tanks and the remaining 20 percent to the grow beds or canals, and this can be controlled with the valve.

4.4.2 Mechanical and biological filtration

Dedicated filtration is of critical importance in both NFT and DWC units. Whereas the medium in the media bed technique serves as a biofilter and a mechanical filter, the NFT and DWC techniques do not have this luxury. Therefore, both types of filters need to be deliberately constructed: first, a physical trap to catch the solid wastes, and then a biological filter for nitrification. As mentioned in Section 4.3, there are many

types of mechanical filters, and NFT and DWC units require those at the high end of the spectrum outlined therein. The designs described in Appendix 8 use a mechanical swirl filter to trap particulate wastes, with periodic venting of the captured solids. On exiting the swirl filter, the water passes through an additional mesh screen to trap any remaining solids and then reaches the biofilter. The biofilter is well oxygenated with air stones and contains a biofiltration media, usually Bioballs®, nylon netting or bottle caps, where the nitrifying bacteria transform the dissolved wastes. With insufficient filtration, both NFT and DWC units would clog, become anoxic and exhibit poor growing conditions for plants and fish alike.

4.4.3 Nutrient film technique grow pipes, construction and planting

Following on from the filtration methods explained above, NFT then employs the use of plastic pipes laid out horizontally to grow vegetables using the aquaponic water (Figure 4.62). Where possible, use pipes of rectangular section with width larger than height, which is standard among hydroponic growers. The reason lies in a larger film of water that hits the roots with the scope of increasing the nutrient uptake and plant growth. One of the benefits of the NFT is that the pipes can be arranged in many patterns, beyond the scope of this publication, and can make use of vertical space, walls and fences, and overhanging balconies (Figure 4.63).

The water is pumped from the biofilter into each hydroponic pipe with a small equal flow creating a shallow stream of nutrient-rich aquaponic water flowing along the bottom. The grow pipes contain a number of holes along the top of the pipe into which the plants are placed. As the plants start to consume the nutrient-rich water from the stream, they begin to develop root systems inside the grow pipes. At the same time, their stems and leaves grow out and around the pipes. The shallow film of water at the bottom of each pipe ensures that the roots receive large amounts of oxygen at the root zone along with moisture and nutrition. Keeping a shallow stream allows the roots to have a larger air exchange surface. The water flow for each grow pipe should be no greater than 1–2 litres/min. The flow rate is controlled from the Y-valve, with all excess water flow returned to the fish tank.

Grow pipe shape and size

It is wise to choose a pipe with the optimum diameter for the types of plants grown. Pipes with a square cross-section are best, but round pipes are more common and totally acceptable. For larger fruiting vegetables, 11 cm diameter grow pipes are needed while fast-growing leafy green and small vegetables with small root masses only require pipes with a diameter of 7.5 cm. For small-scale polyculture (growing many types of vegetables) 11 cm diameter pipes should be used (Figure 4.64). This avoids plant selection limitations because the small plants can always be grown in the larger pipes, although there would be a sacrifice in planting density. Plants with extensive root

FIGURE 4.62
Lettuce growing in square grow pipes of a nutrient film technique unit



FIGURE 4.63
Grow pipes of a nutrient film technique unit arranged vertically





Professional hydroponic pipes for commercial growers are typically this shape, and some growers use vinyl fence posts.

Planting within the grow pipes

The holes drilled into the hydroponic pipe should be 7–9 cm in diameter, and should match the size of the available net cups. There should be a minimum of 21 cm between the centre of each plant hole to allow adequate plant space for leafy greens and larger vegetables (Figures 4.65 and 4.66).

Each seedling is placed into a plastic net cup, which is then in turn placed within the grow pipe. This provides physical support for the plant. The net cups are filled with general purpose hydroponic media (volcanic gravel, rockwool or LECA) around the seedling. If desired, a 5–10 cm length of 5 cm PVC pipe can be placed inside the net cup as further balance and support to the plant. Detailed planting instructions are included in Appendix 8.

If plastic net cups are not available or are too costly, it is possible to use regular plastic drinking cups. Follow the planting procedure as outlined in the previous paragraph making sure to add many



systems, including mature older plants, can clog smaller pipes and cause overflows and losses of water. Be especially mindful of tomatoes and mint, as their massive root systems can easily clog even large pipes.

The grow pipe length can be anywhere between 1 and 12 m. In pipes longer than 12 m, nutrient deficiencies can occur in plants towards the end of the pipes because the first plants have already stripped the nutrients. A slope of about 1 cm/m of pipe length is needed to make sure the water flows through the whole pipe with ease. The slope is controlled by using shims (wedges) on the side away from the fish tank.

PVC pipes are recommended because they are usually the most commonly available and are inexpensive. White pipes should be used as the colour reflects the sun's rays, thereby keeping the inside of the pipes cool. Alternatively, square or rectangular hydroponic pipes with dimensions 10 cm width × 7 cm height are recommended.

holes to the plastic drink cup so the roots have plenty of access into the grow pipe. Other growers have had success with flexible, open-cell foam to support the plants within the grow pipe. If none of these options is available or desired, it is possible to transplant the seedlings directly into the pipes, particularly rectangular pipes (Figure 4.67). Seedlings can be transplanted with their germination medium, which will wash away into the system or the roots can be carefully rinsed, which keeps medium out of the system but can increase the transplant stress. Nevertheless, it is preferable to use net cups filled with media.

When initially planting the seedlings into the pipe, make sure the roots can touch the stream

FIGURE 4.66
Full size lettuce harvested from a nutrient film technique unit. Net cup and PVC extender are clearly visible



FIGURE 4.67
Lettuce plant grown without a net cup directly in a grow pipe



of water at the bottom of the pipe. This will ensure that the young seedlings do not become dehydrated. Alternatively, wicks can be added that trail into the water stream. In addition, it is advisable to water the seedlings with aquaponic water one week prior to transplanting them to the unit. This will help mitigate against transplant shock for the plants as they become accustomed to the new water.

4.5 DEEP WATER CULTURE TECHNIQUE

The DWC method involves suspending plants in polystyrene sheets, with their roots hanging down into the water (Figures 4.68 and 4.69). This method is the most common for large commercial aquaponics growing one specific crop (typically lettuce, salad leaves or basil, Figure 4.70), and is more suitable for mechanization. On a small-scale, this technique is more complicated than media beds, and may not be suitable for some locations, especially where access to materials is limited.

FIGURE 4.68
Illustration of a small deep water culture unit using a media bed as filtration

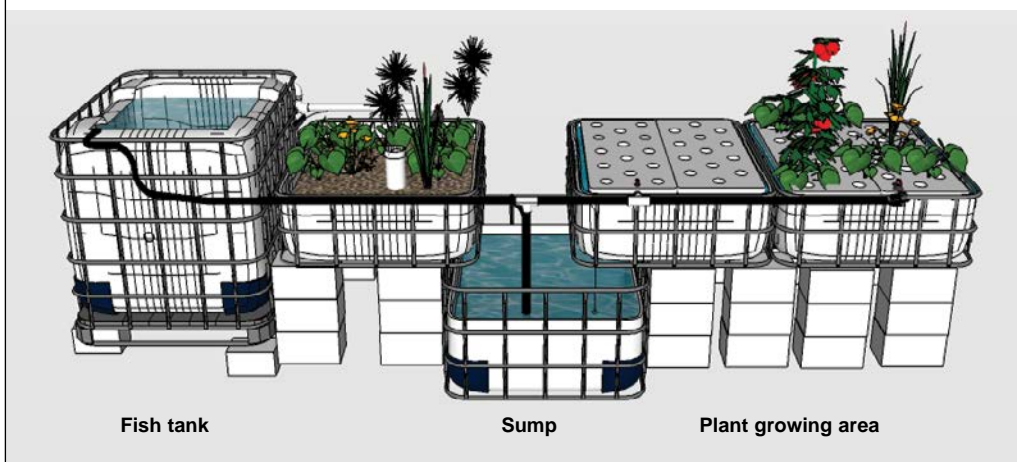

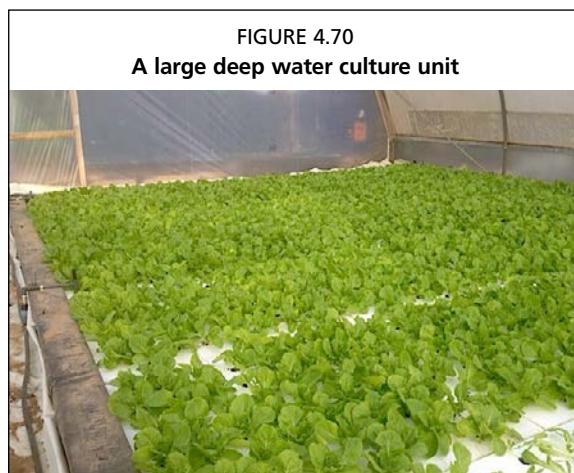
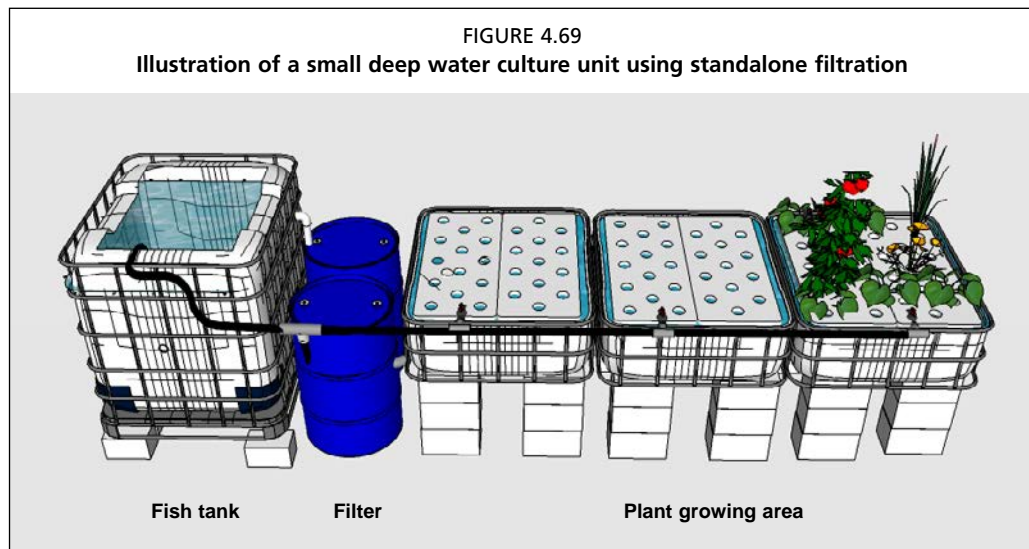

4.5.1 Water flow dynamics

The water flow dynamics in DWC are almost identical to those through an NFT. The water flows by gravity from the fish tank, through the mechanical filter, and into the combination biofilter/sump. From the sump, the water is pumped in two directions through a “Y” connector and valves. Some water is pumped directly back to the fish tank. The remaining water is pumped into the manifold, which distributes the water equivalently through the canals. The water flows, again by gravity, through the grow canals where the plants are located and exits on the far side. On exiting the canals the

water is returned to the biofilter/sump, where again it is pumped either into the fish tank or canals. The water that enters the fish tank causes the fish tank to overflow through the exit pipe and back into mechanical filter, thus completing the cycle.

This “*Figure 8*” configuration describes the path of the water seen in the DWC system. As in the NFT, the water flows through the mechanical filter and the biofilter before being pumped back to the fish tank and the plant canals. One drawback in this configuration is that the combination sump/biofilter returns part of the effluent water from the plant canals back to the plants. However, unlike in the NFT where the nutrients in the small film of water flowing at root level quickly become depleted, the large volume of water contained in the DWC canals allows for considerable amounts of nutrients to be used by plants. Such nutrient availability would also suggest different system designs. A serial distribution of water along the DWC canals can be constructed by simply using a “cascade” configuration with only a single inlet serving the farthest tank. In this case, the outlet of one tank would be the inlet of the successive one, and the increased water flow would help the roots to access a higher flow of nutrients.

In the DWC system shown in Figure 4.68, water is pumped from the biofilter container into canals that have polystyrene sheets floating on top supporting the plant. The flow rate of the water entering each canal is relatively low. Generally, every canal has 1–4 hours of retention time. Retention time is a similar concept to turnover rate, and refers to the amount of time it takes to replace all the water in a container. For example, if the water volume of one canal is 600 litres and the flow rate of water entering the container is 300 litres/h, the retention time would be 2 hours (600 litres ÷ 300 litres/h).

4.5.2 Mechanical and biological filtration

Mechanical and biological filtration in DWC units is the same as in NFT units which is described in Section 4.4.2.

4.5.3 DWC grow canals, construction and planting

Canals can be of variable lengths, from one to tens of metres (Figure 4.71). In general, their length is not an issue, as seen in the NFT, because the large volume of water enables adequate nutrient supply. Optimal plant nutrition in very long canals should always allow for adequate water inflow and re-oxygenation to ensure that nutrients are not depleted and that roots can breathe. As far as the width is concerned, it is generally recommended to be the standard width of a sheet of polystyrene, but it can be multiples of this. However, narrower and longer canals enable a higher water speed that can beneficially hit the roots with larger flows of nutrients. The choice of width should also consider accessibility by the operator. The recommended depth is 30 cm to allow for adequate plant root space. Similar to fish tanks, canals can be made out of any strong inert material that can hold water. For small-scale units, popular materials include fabricated IBC plastic containers or fibreglass. Much larger canals can be constructed using wood lengths or concrete blocks lined with food-grade waterproof sheeting. If using concrete, make sure it is sealed with non-toxic, waterproof sealer to avoid potential toxic minerals leaching from the concrete into the system water.

As mentioned above, the retention time for each canal in a unit is 1–4 hours, regardless of the actual canal size. This allows for adequate replenishment of nutrients in each canal, although the volume of water and the amount of nutrients in the deep canals is sufficient to nourish the plants over longer periods. Plant growth will definitely benefit from faster flow rates and turbulent water because roots will be hit by many more ions; whereas slower flows and almost stagnant water would have a negative impact on plant growth.

Aeration for DWC units is vital. In a densely planted canal, the oxygen demand for plants can cause DO levels to plummet below the minimum. Any decomposing solid waste present in the canal would exacerbate this problem, further diminishing DO. Thus, aeration is required. The simplest method is to place several small air stones in the canals (Figure 4.72). The air stones should release about 4 liters of air per minute, and be arranged every 2–4 m² of canal area. In addition, Venturi siphons (see Section 4.2.5) can be added to the water inflow pipes to aerate the water as it enters the canal. Finally, the Kratky method of DWC can be used (Figure 4.73). In this method, a space of 3–4 cm is left between the polystyrene and the water body inside the canal. This allows air to circulate around the top section of the plant roots. This approach removes the need for air stones in the canal as sufficient amounts of oxygen in the air are supplied to the roots. Another advantage of this method is the avoidance of direct contact of the plant

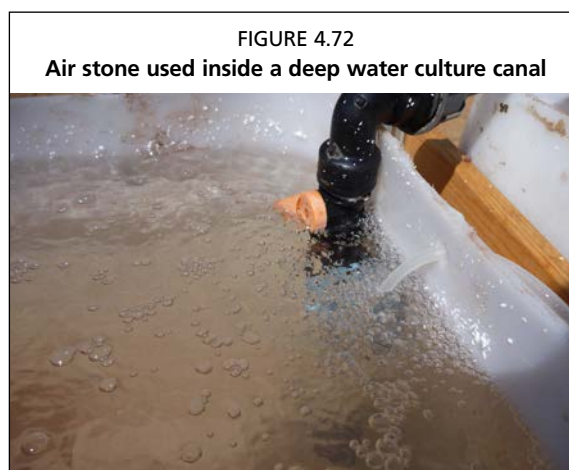
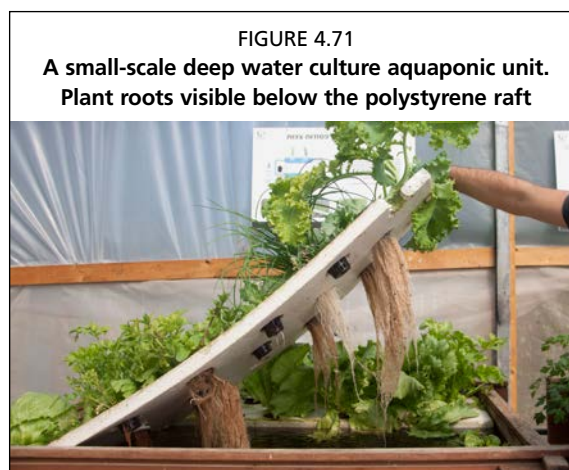

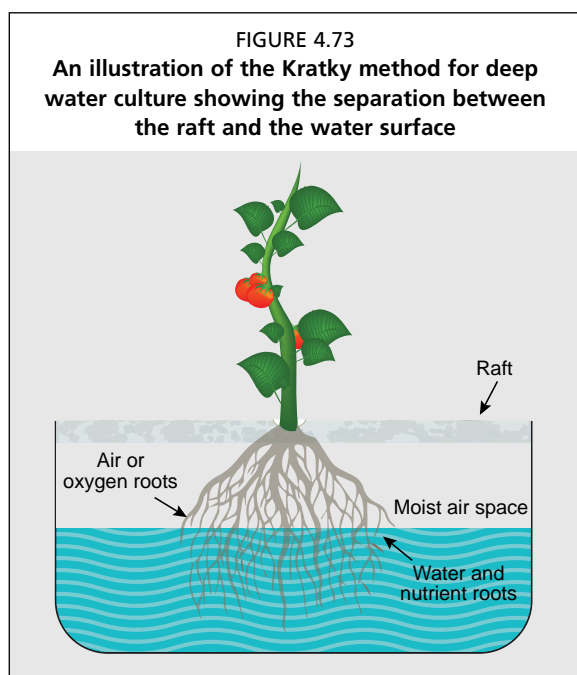

stems with water, which reduces the risks of plant diseases at the collar zone. Moreover, the increased ventilation as a result of the increased air space favours heat dissipation from water, which is ideal in hot climates

Do not add any fish into the canals that could eat the plant roots, e.g. herbivorous fish such as tilapia and carp. However, some small carnivorous fish species, such as guppies, mollies, or mosquito fish, can be used successfully to manage mosquito larvae, which can become a huge nuisance to workers and neighbours in some areas.

The polystyrene sheets should have a certain number of holes drilled to fit the net cups (or sponge cubes) used for supporting each plant (Figure 4.74). The amount and location of the holes is dictated by the vegetable type and the distance desired between the plants, where smaller plants can be spaced more closely. Appendix 8 includes specific details and helpful hints on how to drill the holes.

Seedlings can be started in a dedicated plant nursery (see Section 8.3) in soil blocks or a soil-less medium. Once these seedlings are large enough to handle, they can be transferred into net cups and planted into the DWC unit (Figure 4.75). The remaining space in the net cup should be filled with hydroponic media, such as volcanic gravel, rockwool or LECA, to support the seedling. It is also possible to simply plant a seed straight into the net cups on top of the media. This method is sometimes recommended if vegetable seeds are accessible because it avoids the transplant shock during replanting. When

harvesting, be sure to remove the whole plant, including roots and dead leaves, from the canal. After harvest the rafts should be cleaned but not left to dry so as to avoid killing the nitrifying bacteria on the submerged surface of the raft. Large scale units should clean the rafts with water to remove dirt and plant residues and immediately repositioned in the canals to avoid any stress to the nitrifying bacteria.

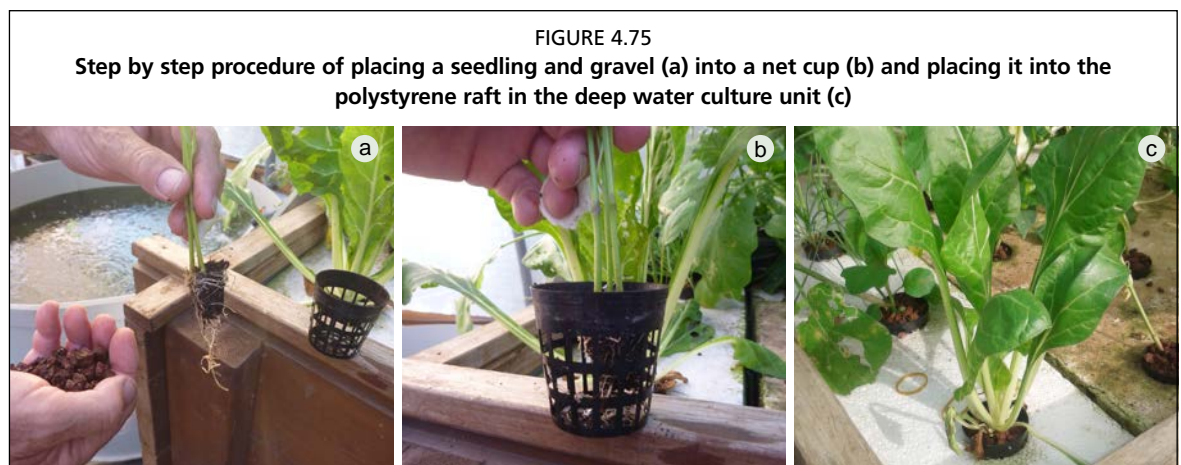

4.5.4 Special case DWC: low fish density, no filters

Aquaponic DWC units can be designed that do not require external additional filtration (Figure 4.76). These units carry a very low stocking density of fish (i.e. 1–1.5 kg of fish per m³ of fish tank), and then rely mainly on the plant root space and interior area of the canals as the surface area to house the nitrifying bacteria. Simple mesh screens capture the large solid waste, and the canals serve as settling tanks for fine waste. The advantage to this method is the reduction in initial economic investment and capital costs, while at the same time eliminating the need for additional filter containers and materials, which can be difficult and expensive to source in some locations. However, lower stocking densities will lead to lower fish production. At the same time, many aquaponic ventures make the vast majority of their profits on the plant yield rather than the fish production, essentially only using the fish as a source of nutrients. Often, this method requires nutrient supplementation to ensure plant growth. If considering this method, it is worth to assessing the desired fish and plant production and considering the relative costs and gains.

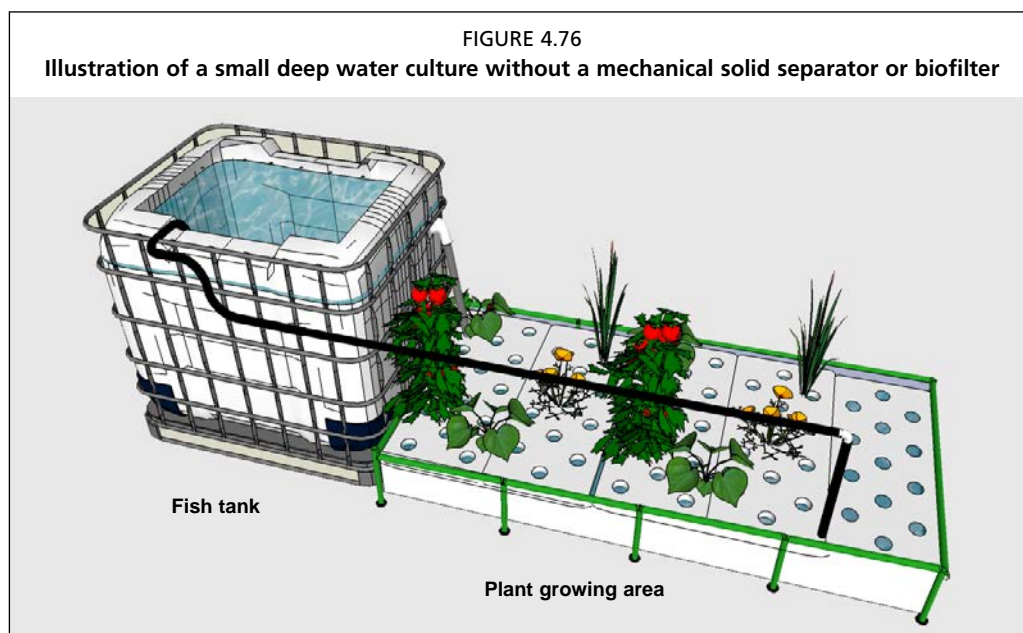

Water flow dynamics

The main difference between the two designs (high fish stocking vs. low fish stocking) is that the low-density design does not use either of the external filtration containers, mechanical or biological. Water flows by gravity from the fish tank straight into DWC canals, passing through a very simple mesh screen. Water is then returned either to a sump and pumped back to the fish tanks, or directly to the fish tanks without a sump. Water in both the fish tanks and canals is aerated using an air pump. The fish waste is broken down by nitrifying and mineralizing bacteria living on the plant root surface and the canal walls.

The fish stocking density is a continuum, stretching from very low densities that do not need filters all the way up to very high densities that need dedicated external filters. One simple solution to procure additional mineralization and biofiltration and to avoid waste accumulation of solids at the bottom of the canals consists in combining the simple mesh screen with a basket of pea gravel or clay balls positioned just above the water level where the water exits the fish tank. The basket would act as a trickling filter with its media trapping and mineralizing the solids. The water falling from the basket would also add oxygen through its splash effect. In addition, the use of pea gravel would have a buffering action against water acidification following

nitrification. Another option can include an internal biofilter within the fish tank, consisting of a simple mesh bag of biofilter material near an air stone. This can help to ensure adequate biofiltration without adding to the cost of external biofilters. Finally, increasing the overall water volume without increasing the fish stocking density, basically using large fish tanks for few fish, can help to mitigate water quality issues by diluting wastes and ensuring adequate time for the farmer to respond to changes before the fish become stressed, though this can dilute the available nutrients and hinder vegetable growth.

The lower fish density also means that the water flow rate can be lower. A smaller pump can be used, reducing the cost, but ensure that at least half of the total fish tank volume is exchanged per hour. In fact, some researchers have had success with removing the electric pump all together and relying on manual labour to cycle the water twice per day. However, these systems are utterly dependent on adequate aeration. Other than these differences, the recommendations for fish tanks and DWC canal construction are applicable for this low stocking density method.

Low stocking density unit management

The major difference from the management of the other units, discussed in more detail in Chapter 8, is the lower stocking density. The suggested stocking density for these types of systems is 1–5 kg/m³ (compare to 10–20 kg/m³ for other systems in this manual). Previously, it has been suggested that the balance between fish and plants follows the feed rate ratio, which helps to calculate the amount of fish feed entering the system given a set growing area for the plants. These low stocking density units still follow the suggested daily feed rate ratio of 40–50 g/m², but should be towards the lower end. A useful technique is to allow fish to feed for 30 minutes, 2–3 times per day, and then remove all uneaten food. Overfeeding will result in an accumulation of waste in the fish tanks and canals, leading to anoxic zones, poor growing conditions, diseases, and fish and plant stress. Always, but especially when using this method without filters, be sure to monitor water quality conditions closely, and reduce feeding if high ammonia or nitrite levels are detected.

Advantages and disadvantages of low stocking density

The major advantage is a simpler unit. This system is easier to construct and cheaper to begin, having lower capital costs. The fish are less stressed because they are grown in more spacious conditions. Overall, this technique can be very useful for initial projects with low capital. These systems can be very useful for growing high-value fish, such as ornamental fish, or specialty crops, such as medicinal herbs, where the lower production is compensated with higher value.

However, a serious disadvantage is that these units are hard to scale up. Fewer plants and fish are grown in a given area, so they are less intensive than some of the systems previously outlined. In order to produce a large amount of food, these systems would become prohibitively large. Essentially, the external mechanical and biofilters are what allow aquaponics to be very intensive within a small area.

Furthermore, fish production cannot function independently from the hydroponic component; plants must be in the canals at all times. The plant roots provide the area for bacteria growth, and without these roots the biofiltration would not be sufficient to keep the water clean for the fish. If it were ever necessary to harvest all the plants at once, which can occur during disease outbreaks, season changes or major climate events, the reduced biofiltration would cause high ammonia and fish stress. On the other hand, with external mechanical and biofilters the fish production can continue without the hydroponics as a standard RAS.

4.6 COMPARING AQUAPONIC TECHNIQUES

Table 4.2 below provides a quick reference and comparative summary of the various aquaponic culture systems described above.

TABLE 4.2

Strengths and weaknesses of main aquaponic techniques

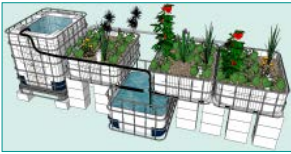
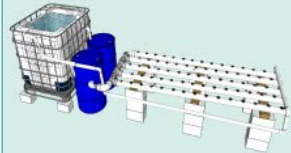
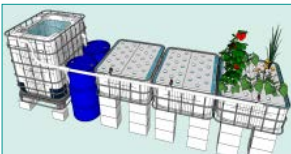
System type	Strengths	Weaknesses
Media bed units 	Simple and forgiving design Ideal for beginners Alternative/recycled parts can be used Tall fruiting vegetables are supported All types of plants can be grown Multiple irrigation techniques Many types of media can be used High aeration when using bell siphons Relatively low electrical energy Medium captures and mineralizes solids	Very heavy, depending on choice of media Media can be expensive Media can be unavailable Unwieldy at large scale Higher evaporation than NFT and DWC Labour-intensive to construct Flood-and-drain cycles require careful calculation of water volume Media can clog at high stocking density Plant transplanting is more labour-intensive as the media needs to be moved If water delivery is not uniform, plant performance may differ from bed to bed
NFT units 	More cost-effective than media beds on large scale Ideal for herbs and leafy green vegetables Minimal water loss by evaporation Light weight system Best method for rooftops Very simple harvesting methods Pipes spacing can be adjusted to suit different plants Well researched by commercial hydroponic ventures Smallest water volume required Minimal labour to plant and harvest	More complex filtration method Water pump and air pump are mandatory Cannot directly seed Low water volume magnifies water quality issues Increases variability in water temperature with stress on fish Water inlet pipes can easily clog Vulnerable to power outages
DWC units 	More cost-effective method than media beds on large scale Large water volume dampens changes in water quality Can withstand short interruptions in electricity Minimal water loss by evaporation Well researched by commercial hydroponic ventures Polystyrene rafts insulate water from heat losses/gains keeping constant temperatures Shifting rafts can facilitate planting and harvest Rafts provide biofilter surface area DWC canals can be fixed with plastic liners using almost any kind of wall (wood, steel frames, metal profiles) Can be used at multiple stocking densities	More complex filtration method Very heavy unit High dissolved oxygen required in the canal, and a more sophisticated air pump is required Plastic liners must be food-grade Polystyrene sheets are easily broken Tall plants are more difficult to support Large water volume increases humidity and the risk of fungal disease

4.7 CHAPTER SUMMARY

- The main factors when deciding where to place a unit are: stability of ground; access to sunlight and shading; exposure to wind and rain; availability of utilities; and availability of a greenhouse or shading structure.
- There are three main types of aquaponics: the media bed method, also known as particulate bed; the nutrient film technique (NFT) method; and the deep water culture (DWC) method, also known as the raft method or floating system.

- The essential components for all aquaponic units are: the fish tank, the mechanical and biological filtration, the plant growing units (media beds, NFT pipes or DWC canals), and the water/air pumps.
- The media beds must: (i) be made of strong inert material; (ii) have a depth of about 30 cm; (iii) be filled with media containing a high surface area; (iv) provide adequate mechanical and biological filtration; (v) provide separate zones for different organisms to grow; and (vi) be sufficiently wetted through flood-and-drain or other irrigation techniques to ensure good filtration.
- For NFT and DWC units, mechanical and biofiltration components are necessary in order to respectively remove the suspended solids and oxidize the dissolved wastes (ammonia to nitrate).
- For NFT units, the flow rate for each grow pipe should be 1–2 litres/minute to ensure good plant growth.
- For DWC units each canal should have a retention time of 2–4 hours.
- High DO concentration is essential to secure good fish, plant and bacteria growth. In the fish tank DO is supplied by means of air stones. Media bed units have an interface between the wet zone and dry zone that provides a high availability of atmospheric oxygen. In NFT units, additional aeration is provided into the biofilter, while in DWC air stones are positioned in both biofilter and plant canals.

5. Bacteria in aquaponics

Bacteria are a crucial and pivotal aspect of aquaponics, serving as the bridge that connects the fish waste to the plant fertilizer. This biological engine removes toxic wastes by transforming them into accessible plant nutrients. Chapter 2 discussed the nitrogen cycle, especially the critical role of nitrifying bacteria, and outlined the essential parameters for maintaining a healthy colony. Chapter 4 discussed the aspects of biofilter materials that host these same bacteria. This brief chapter serves as a review of the bacteria, including details of the important bacterial groups. Heterotrophic bacterial activity is more fully discussed in terms of its role in the mineralization of solid fish waste. Unwanted bacteria are discussed, including: denitrifying bacteria, sulphate-reducing bacteria and pathogens. Finally, the timeline of bacterial cycling is discussed in regard to the establishment of a new aquaponic system.

5.1 NITRIFYING BACTERIA AND THE BIOFILTER

Chapter 2 discussed the vital role of nitrifying bacteria in regard to the overall aquaponic process. The nitrifying bacteria convert the fish waste, which enters the system mainly as ammonia, into nitrate, which is fertilizer for the plants (Figure 5.1). This is a two-step process, and two separate groups of nitrifying bacteria are involved. The first step is converting ammonia to nitrite, which is done by the ammonia-oxidizing bacteria (AOB). These bacteria are often referred to by the genus name of the most common group, the *Nitrosomonas*. The second step is converting nitrite to nitrate is done by the nitrite-oxidizing bacteria (NOB). These are commonly referred to by the genus name of the most common group, the *Nitrobacter*. There are many species within these groups, but for the purposes of this publication, the individual differences are not important, and it is more useful to consider the group as a whole. The nitrification process occurs as follows:

- 1) AOB bacteria convert ammonia (NH_3) into nitrite (NO_2^-)
- 2) NOB bacteria then convert nitrite (NO_2^-) into nitrate (NO_3^-)

Nitrification and, therefore, a healthy bacterial colony is essential to a functioning aquaponic system. Nitrifying bacteria are relatively slow to reproduce and establish colonies, requiring days and sometimes weeks, and therefore the patience of the farmer is one of the most important management parameters when establishing a new aquaponic system. Many aquariums and aquaponic systems have failed because too many fish were added before the colony of bacteria was fully developed. There are several other key parameters to support nitrifying bacteria. Generally, bacteria require

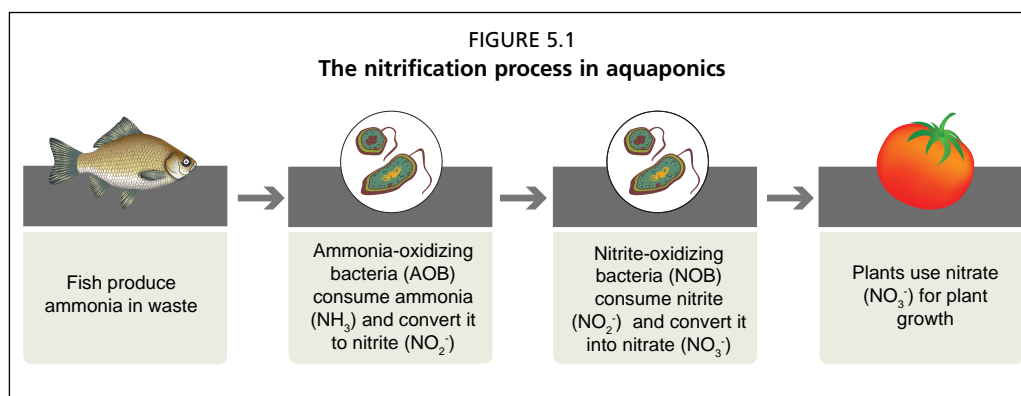

a large, dark location to colonize with good water quality, adequate food and oxygen. Often, nitrifying bacteria form a slimy, light brown or beige matrix on the biofilter, and have a distinctive odour that is difficult to describe, but does not smell particularly foul which could indicate other micro-organisms.

5.1.1 High surface area

Biofiltration material with a high specific surface area (SSA) is optimal to develop extensive colonies of nitrifying bacteria. SSA is a ratio defining the surface area exposed from a given volume of media, and is expressed in square metres per cubic metres (m^2/m^3). In general, the smaller and more porous the particles of the media, the greater is the surface available for bacteria to colonize. This results in more efficient biofiltration. There are many such materials used in aquaponics, either as growing media or for biofiltration, e.g. volcanic gravel, expanded clay, commercial plastic biofilter balls, and plant roots. The volcanic tuff and Bioballs® considered in this manual have, respectively, $300 \text{ m}^2/\text{m}^3$ and $600 \text{ m}^2/\text{m}^3$, which is an adequate SSA to enable bacteria to thrive. Further characteristics and SSA of the different media used in aquaponics are summarized in Table 4.1 and Appendix 4. If the biofilter material is not ideal and has a lower surface area to volume ratio, then the biofilter should be larger. An oversized biofilter cannot harm an aquaponic system, and although overly large biofilters would add unnecessary expense, excess biofiltration capacity has saved many systems from collapse.

5.1.2 Water pH

Nitrifying bacteria function adequately through a pH range of 6–8.5. Generally, these bacteria work better at higher pH, with the *Nitrosomonas* group preferring a pH of 7.2–7.8, and the *Nitrobacter* group preferring a pH of 7.2–8.2. However, the target pH for aquaponics is 6–7, which is a compromise between all of the organisms within this ecosystem. Nitrifying bacteria function adequately within this range, and any decrease in bacterial activity can be offset with a larger biofilter.

5.1.3 Water temperature

The optimal temperature range for nitrifying bacteria is 17–34 °C. This range encourages growth and productivity. If the water temperature drops below this range, the productivity of the bacteria will tend to decrease. In particular, the *Nitrobacter* group is less tolerant of lower temperature than is the *Nitrosomonas* group, and as such, during colder periods nitrite should be more carefully monitored to avoid harmful accumulations.

5.1.4 Dissolved oxygen

Nitrifying bacteria need adequate levels of DO in the water at all times to grow healthily and maintain high levels of productivity. Nitrification is a reduction/oxidation (redox) reaction, where the bacteria derive the energy to live when oxygen is combined with the nitrogen. Optimum levels of DO are 4–8 mg/litre, which is also the level required for the fish and the plants. Nitrification does not occur if the DO concentration drops below 2 mg/litre. Ensure adequate biofiltration by dedicating aeration to the biofilter, either through flood-and-drain cycles in media beds, air stones in external biofilters, or cascading water return lines to the canals and sump tanks.

5.1.5 UV light

Nitrifying bacteria are photosensitive until they fully establish a colony, and sunlight can cause considerable harm to the biofilter. Media beds already protect the bacteria from sunlight; but if using an external biofilter, be sure to keep it shaded from direct sunlight.

5.1.6 Monitoring bacterial activity

If all of these five parameters are respected, it is safe to assume that the bacteria are present and functioning properly. That said, bacteria are so important to aquaponics that it is worth knowing the overall health of the bacteria at any given time. However, bacteria are microscopic organisms, and it is impossible to see them without a microscope. There is a simple method to monitor the bacterial function; testing for ammonia, nitrite and nitrate provides information on the health of the bacterial colony. Ammonia and nitrite should always be 0–1 mg/litre in a functioning and balanced aquaponic unit. If either is detectable, it indicates a problem with the nitrifying bacteria. There are two possible, common reasons for this to occur. First, the biofilter is too small for the amount of fish and fish feed. Therefore, there is an imbalance and there are too many fish. To rectify, either increase the biofilter size or reduce the number of fish, or the fish feeding regime. Sometimes, this problem can occur when the system started out balanced when the fish were smaller, but gradually became unbalanced as the fish grew and were fed more with the same size biofilter. Second, if the system is balanced in size, then the bacteria themselves may not be functioning properly. This could indicate a problem with the water quality, and each parameter listed above should be checked. Often, this can occur during winter seasons as the water temperature begins to fall and bacterial activity slows.

5.2 HETEROTROPHIC BACTERIA AND MINERALIZATION

There is another important bacteria group, as well as other micro-organisms, involved in aquaponics. This bacteria group is generally called the heterotrophic group. These bacteria utilize organic carbon as its food source, and are mainly involved in the decomposition of solid fish and plant waste. Most fish only retain 30–40 percent of the food they eat, meaning that 60–70 percent of what they eat is released as waste. Of this waste, 50–70 percent is dissolved waste released as ammonia. However, the remaining waste is an organic mix containing proteins, carbohydrates, fats, vitamins and minerals. The heterotrophic bacteria metabolize these solid wastes in a process called mineralization, which makes essential micronutrients available for plants in aquaponics (Figure 5.2).

These heterotrophic bacteria, as well as some naturally occurring fungi, help decompose the solid portion of the fish waste. In doing so, they release the nutrients locked in the solid waste into the water. This mineralization process is essential because plants cannot take up nutrients in solid form. The wastes must be broken into simple molecules in order to be absorbed by plants' roots. Heterotrophic bacteria feed on any form of organic material, such as solid fish waste, uneaten fish food, dying plants, dying plant leaves and even dead bacteria. There are many sources of food available for these bacteria in aquaponic units.

Heterotrophic bacteria require similar growing conditions to the nitrifying bacteria especially in high levels of DO. The heterotrophic bacteria colonize all components of the unit, but are especially concentrated where the solid waste accumulates. Heterotrophic bacteria grow much faster than the nitrifying bacteria, reproducing in hours rather than days. In media beds, the wastes collect on the bottom, permanently wet zone and many heterotrophic bacteria are found here. In other systems, the main colonies are found on the filters and separators, and in the canals. Mineralization is important in aquaponics because it releases several micronutrients that

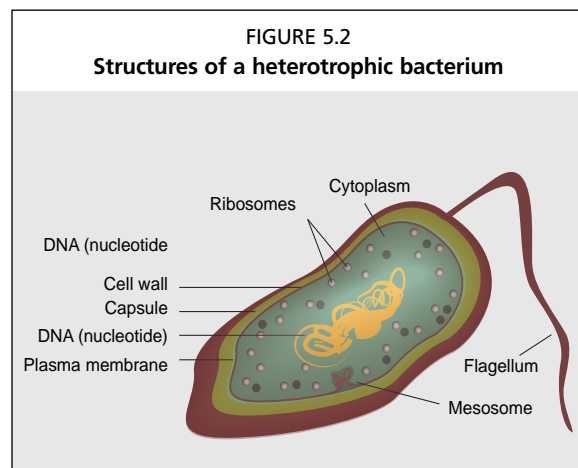

are necessary to plant growth. Without mineralization, some plants may experience nutrient deficiencies and would need supplemental fertilizer.

Heterotrophic bacteria are aided in the decomposition of solid waste by a community of other organisms. Often, earthworms, isopods, amphipods, larvae and other small animals can be found in aquaponic systems, especially within media beds. These organisms work together with the bacteria to decompose the solid waste, and having this community can prevent accumulation of solids.

5.3 UNWANTED BACTERIA

5.3.1 Sulphate reducing bacteria

Nitrifying and mineralizing bacteria are useful to aquaponic systems, but some other types of bacteria are harmful. One of these harmful groups of bacteria is the sulphate-reducing group. These bacteria are found in anaerobic conditions (no oxygen), where they obtain energy through a redox reaction using sulphur. The problem is that this process produces hydrogen sulphide (H_2S), which is extremely toxic to fish. These bacteria are common, found in lakes, saltmarshes and estuaries around the world, and are part of the natural sulphur cycle. These bacteria are responsible for the odour of rotten eggs, and also the grey-black colour of sediments. The problem in aquaponics is when solid wastes accumulate at a faster pace than the heterotrophic bacteria and associated community can effectively process and mineralize them, which can in turn lead to anoxic festering conditions that support these sulphate-reducing bacteria. In high fish density systems, the fish produce so much solid waste that the mechanical filters cannot be cleaned fast enough, which encourages these bacteria to multiply and produce their noxious metabolites. Large aquaponic systems often contain a degassing tank where the hydrogen sulphide can be released safely back to the atmosphere. Degassing is unnecessary in small-scale systems. However, even in small-scale systems, if a foul odor is detected, reminiscent of rotten eggs or raw sewage, it is necessary to take appropriate management action. These bacteria only grow in anoxic conditions, so to prevent them, be sure to supply adequate aeration and increase mechanical filtration to prevent sludge accumulation.

5.3.2 Denitrifying bacteria

A second group of unwanted bacteria are those responsible for denitrification. These bacteria also live in anaerobic conditions. They convert nitrate, which is the coveted fertilizer for plants, back into atmospheric nitrogen that is unavailable for plants. These bacteria are also common throughout the world, and are important in their own right (see Figure 2.4). However, within aquaponic systems, these bacteria can decrease efficiency by effectively removing the nitrogen fertilizer. This is often a problem with large DWC beds that are inadequately oxygenated. A problem could be suspected when plants show signs of nitrogen deficiencies despite the system being in balance, and when there is a very low nitrate concentration in the water. Investigate possible areas within the DWC canals that are not circulating properly, and further increase aeration with air stones.

Some large aquaponic systems deliberately use denitrification. The feed rate ratio balances the nutrients for the plants but usually results in high nitrate levels. This nitrate can be diluted during water exchanges (suggested in this publication for small-scale systems). Alternatively, controlled denitrification can be encouraged in the mechanical filter. This technique requires careful attention and off-gassing, and is not recommended for small-systems. More information can be found in the section on Further Reading.

5.3.3 Pathogenic bacteria

A final group of unwanted bacteria are those that cause diseases in plants, fish and humans. These diseases are treated separately in other parts of this publication, with

Chapters 6 and 7 discussing plant and fish disease, respectively, and Section 8.6 discussing human safety. Overall, it is important that there are good agricultural practices (GAPs) that mitigate and minimize the risk of bacterial diseases within aquaponic systems. Prevent pathogens from entering the system by: ensuring good worker hygiene; preventing rodents from defecating in the system; keeping wild mammals (and dogs and cats) away from aquaponic systems; avoiding using water that is contaminated; and being aware that any live feed can be a vector for introducing alien micro-organisms into the system. It is especially important not to use rainwater collection from roofs with bird faeces unless the water is treated first. The major risk from warm-blooded animals is the introduction of *Escherichia coli*, and birds often carry *Salmonella* spp.; dangerous bacteria can enter the system with animal faeces. Second, after prevention, never let the aquaponic water come into contact with the leaves of the plants. This prevents many plant diseases as well as potential contamination of fish water to human produce, especially if the produce is to be eaten raw. Always wash vegetables before consumption, aquaponic or otherwise. Generally, common sense and cleanliness are the best guards against diseases from aquaponics. Additional sources for aquaponic food safety are provided throughout this publication and in the section on Further Reading.

5.4 SYSTEM CYCLING AND STARTING A BIOFILTER COLONY

System cycling is a term that describes the initial process of building a bacterial colony when first starting any RAS, including an aquaponic unit. Under normal circumstances, this takes 3–5 weeks; cycling is a slow process that requires patience. Overall, the process involves constantly introducing an ammonia source into the aquaponic unit, feeding the new bacterial colony, and creating a biofilter. The progress is measured by monitoring the nitrogen levels. Generally, cycling takes place once an aquaponic system is built, but it is possible to give the biofilter a head start when creating a new aquaponic system. It is important to understand that during the cycling process there will be high levels of ammonia and nitrite, which could be harmful to fish. Also, make sure all aquaponic components, in particular the biofilter and fish tank, are protected from direct sunlight before starting the process.

Once introduced into the unit, the ammonia becomes an initial food source for the AOB, a few of which are naturally occurring and recruit to the system on their own. They can be found on land, in water and in the air. Within 5–7 days after the first addition of ammonia, the AOB start forming a colony and begin to oxidize the ammonia into nitrite. Ammonia should be continuously, but cautiously, added to ensure adequate food for the developing colony without becoming toxic. After another 5–7 days the nitrite levels in the water will have started to rise, which in turn attracts the NOB. As the NOB populations increase, the nitrite levels in the water will start to decline as nitrite is oxidized into nitrate. The full process is illustrated in Figure 5.3, which shows the trends of ammonia, nitrite and nitrate in the water over the first 20–25 days of cycling.

The end of the cycling process is defined as when the nitrate level is steadily increasing, the nitrite level is 0 mg/litre and the ammonia level is less than 1 mg/litre. In good conditions, this takes about 25–40 days, but if the water temperature is cool, complete cycling may take up to two months to finish. At this point, a sufficient bacterial colony has formed and is actively converting the ammonia to nitrate.

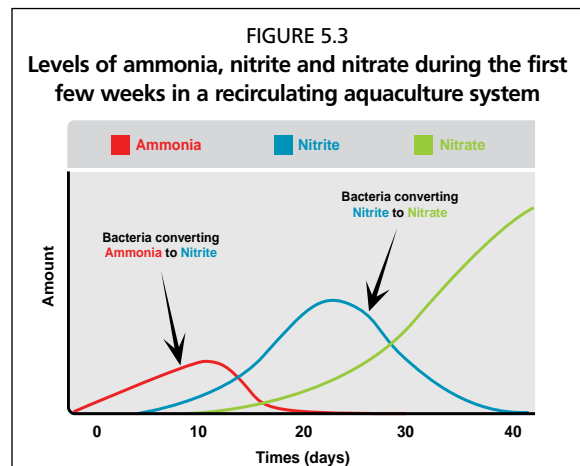

The reason this process is long is because nitrifying bacteria grow relatively slowly, requiring 10–15 hours to double in population. However, some heterotrophic bacteria can double in as little as 20 minutes.

Aquarium or aquaculture retailers sell various products containing living nitrifying bacteria (in a bottle). Once added to the unit, they immediately colonize a system thus avoiding the cycling process explained above. However, these products may be expensive or unavailable and ultimately unnecessary, as the cycling process can be achieved using organic means. Alternatively, if another aquaponic system is available, it is extremely helpful to share part of the biofilter as a seed of bacteria for the new system. This greatly decreases the time necessary for cycling the system. It can also be useful to separately start a biofilter medium by continuously trickling a solution containing 2–3 mg/litre of ammonia for a few weeks in advance. The media would then function as a primer by simply incorporating it into the new aquaponic biofilter. A simple trickling system can be built by suspending a wide plastic crate of medium above a small tank containing the ammonia solution that is being circulated by a small aquarium pump.

Many people use fish as the original source of ammonia in a new tank. However, these fish suffer the effects of high ammonia and high nitrite throughout the cycling process. Many new aquarists do not have the patience to allow a tank to fully cycle and the result is that the new fish die, commonly referred to as “new tank syndrome”. If using fish, it is recommended to use a very low stocking density ($\leq 1 \text{ kg/m}^3$). Instead of using fish, there are other sources of this initial ammonia to start feeding the biofilter colony. Some possible sources include fish feed, sterilized animal waste, ammonium nitrate fertilizer and pure ammonia. Each of these sources has positives and negatives, and some sources are far better and safer to use than others.

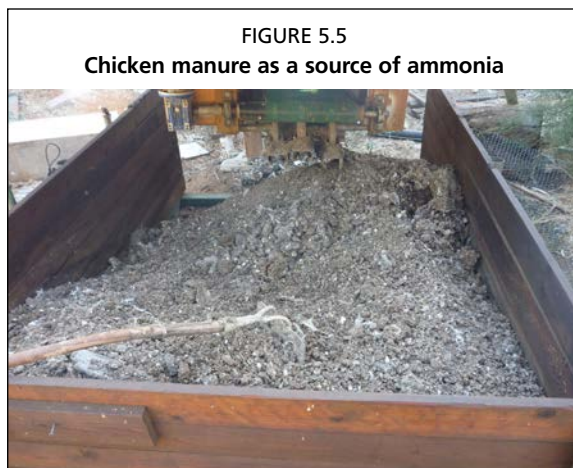
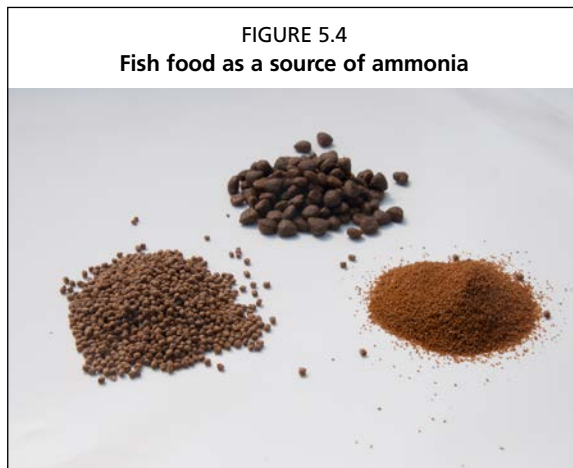

The best ammonia source is finely ground fish food because it is a biologically safe product, and it is relatively easy to control the amount of ammonia being added (Figure 5.4). Be sure to use fresh, unspoiled and disease-free fish feed only. Chicken waste, despite being an excellent ammonia source, can be very risky and can introduce dangerous bacteria into the aquaponic system (Figure 5.5). *Escherichia coli* and *Salmonella* spp. are commonly found in chicken and other animal manure and, therefore, any manure must be sterilized before use. Household ammonia products can be used, but be sure that the product is 100 percent ammonia and does not include other ingredients such as detergents, colourants or heavy metals that could ruin the entire system. Once the ammonia source has been selected, it is important to add the ammonia slowly and consistently, and to monitor the nitrogen levels every 2–3 days (Figure 5.6). It is useful to record levels on a graph to track the process of the cycling. It is important not to add too much ammonia, and it is better to have a little bit too little than too much. The target level is 1–2 mg/litre. If ammonia levels ever exceed 3 mg/litre, it is necessary to do a water exchange to dilute the

ammonia in order to prevent it from inhibiting the bacteria.

5.4.1 Adding fish and plants during the cycling process

Plants and fish should be added only after the cycle is complete. Plants can be added a little bit earlier, but expect nutrient deficiencies in these early plants during this period because other nutrients take time to reach optimal concentrations (Figure 5.7).

Only once the ammonia and nitrite levels are below 1 mg/litre it is safe to start stocking the fish. Always start stocking the fish slowly. Once fish have been stocked, it is not uncommon to see a secondary and smaller ammonia and nitrite spike. This happens if the ammonia created from the newly stocked fish is much greater than the daily ammonia amounts added during the cycling process. Continue to monitor the levels of all three types of nitrogen, and be prepared to do water exchanges if ammonia or nitrite levels rise above 1 mg/litre while the system continues to cycle.

5.5 CHAPTER SUMMARY

- In aquaponics, ammonia must be oxidized into nitrate to prevent toxicity to fish.
- The nitrification process is a two-step bacterial process where ammonia-oxidizing bacteria convert ammonia (NH_3) into nitrite (NO_2^-), and then nitrite-oxidizing bacteria convert nitrite into nitrate (NO_3^-).
- The five most important factors for good nitrification are: high surface area media for bacteria to grow and colonize; pH (6–7); water temperature (17–34 °C); DO (4–8 mg/litre); cover from direct exposure to sunlight
- System cycling is the initial process of building a nitrifying bacteria colony in a new aquaponic unit. This 3–5 week process involves adding an ammonia source into the system (fish feed, ammonia-based fertilizer, up to a concentration in water of 1–2 mg/litre) in order to stimulate nitrifying bacteria growth. This should be done slowly and consistently. Ammonia, nitrite and nitrate are monitored to determine the status of the biofilter: the peak and subsequent drop of ammonia is followed by a similar pattern of nitrite before nitrate starts to accumulate. Fish and plants are only added when ammonia and nitrite levels are low and the nitrate level begins to rise.
- Ammonia and nitrite tests are used to monitor the function of the nitrifying bacteria and the performance of the biofilter. In a functioning system, ammonia and nitrite should be close to 0 mg/litre. High levels of either ammonia or nitrite require a water change and management action. Usually, poor nitrification is due to a change in water temperature, DO or pH levels.
- Another class of micro-organisms naturally occurring in aquaponics is that of heterotrophic bacteria. They decompose the solid fish waste, releasing some of the nutrients into the water in a process called mineralization.

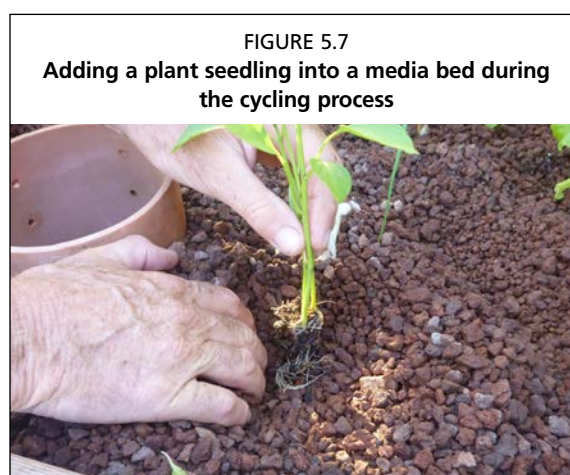
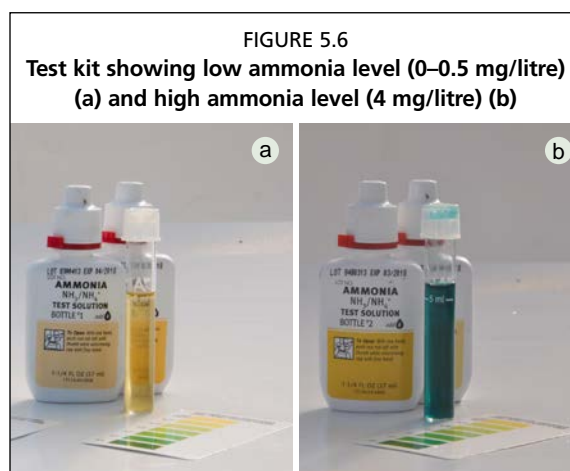

6. Plants in aquaponics

This chapter discusses the theory and practice needed for successful plant production in aquaponic systems. First, it highlights some of the major differences between ground-grown crop production and soil-less crop production. Following this, there is a discussion on some essential plant biology and plant nutrition concepts, focusing on the most important aspects for aquaponics. After, there is a brief section on recommendations for selecting vegetables to grow in aquaponic units. The final two sections cover plant health, methods to maintain plant health, and some advice on how to make the most of the plant growing space.

In many commercial aquaponic ventures, the vegetable production is more profitable than the fish. However, there are exceptions, and some farmers earn more from particularly valuable fish. Estimates from commercial aquaponic units predominantly in the West suggest that up to 90 percent of the financial gains can come from plant production. One reason is the fast turnover rate of vegetables compared with the fish.

Further information on aquaponic plant production is covered in Chapter 8 and in the appendixes. Chapter 8 discusses practices to manage plant production through the seasons, and discusses different approaches for each of the hydroponic methods (media bed, NFT and DWC). Appendix 1 is a technical description of 12 popular vegetables to grow in aquaponics; Appendix 2 contains descriptions and tables detailing several organic treatments of pests and diseases.

6.1 MAJOR DIFFERENCES BETWEEN SOIL AND SOIL-LESS CROP PRODUCTION

There are many similarities between in-ground soil-based agriculture and soil-less production, while the basic plant biology is always the same (Figures 6.1 and 6.2). However it is worth investigating major differences between soil and soil-less production (Table 6.1) in order to bridge the gap between traditional in-ground practices and newer soil-less techniques. Generally, the differences are between the use of fertilizer and consumption of water, the ability to use non-arable land, and overall productivity. In addition, soil-less agriculture is typically less labour-intensive. Finally, soil-less techniques support monocultures better than does in-ground agriculture.

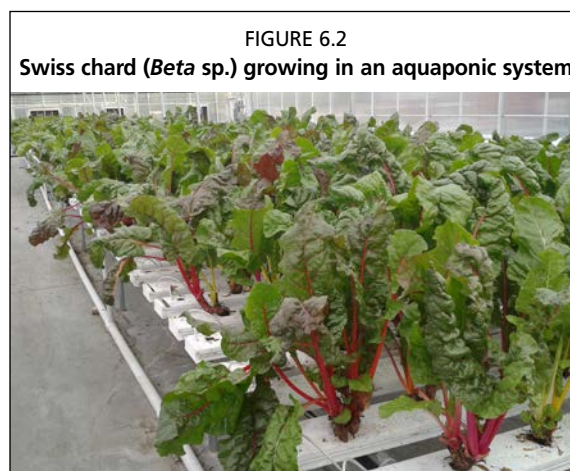

6.1.1 Fertilizer

Soil chemistry, especially relating to the availability of nutrients and the dynamics of fertilizers, is a full discipline and fairly complex. Fertilizer addition is required for

intensive in-ground cultivation. However, farmers cannot fully control the delivery of these nutrients to plants because of the complex processes occurring in the soil, including biotic and abiotic interactions. The sum of these interactions determines the availability of the nutrients to the plant roots. Conversely, in soil-less culture, the nutrients are dissolved in a solution that is delivered directly to the plants, and can be tailored specifically to plants' needs. Plants in soil-less culture grow in contained inert media. These media do not interfere with the delivery of nutrients, which can occur in soil. In addition, the media physically support the plants and keep the roots wet and aerated. Moreover, with in-ground agriculture, some of the fertilizer may be lost to weeds and runoff, which can decrease efficiency while causing environmental concerns. Fertilizer is expensive and can make up a large part of the budget for in-ground farming.

The tailored management of fertilizer in soil-less agriculture has two main advantages. First, minimal fertilizer is lost to chemical, biological or physical processes. These losses decrease efficiency and can add to the cost. Second, the nutrient concentrations can be precisely monitored and adjusted according to the requirements of the plants at particular growth stages. This increased control can improve productivity and enhance the quality of the products.

6.1.2 Water use

Water use in hydroponics and aquaponics is much lower than in soil production. Water is lost from in-ground agriculture through evaporation from the surface, transpiration through the leaves, percolation into the subsoil, runoff and weed growth. However, in soil-less culture, the only water use is through crop growth and transpiration through the leaves. The water used is the absolute minimum needed to grow the plants, and only a negligible amount of water is lost for evaporation from the soil-less media. Overall, aquaponics uses only about 10 percent of the water needed to grow the same plant in soil. Thus, soil-less cultivation has great potential to allow production where water is scarce or expensive.

6.1.3 Utilization of non-arable land

Owing to the fact that soil is not needed, soil-less culture methods can be used in areas with non-arable land. One common place for aquaponics is in urban and peri-urban areas that cannot support traditional soil agriculture. Aquaponics can be used on the ground floor, in basements (using grow lights) or on rooftops. Urban-based agriculture can also reduce the production footprint because transport needs are greatly reduced; urban agriculture is local agriculture and contributes to the local economy and local food security. Another important application for aquaponics is in other areas where traditional agriculture cannot be employed, such as in areas that are extremely dry (e.g. deserts and other arid climates), where the soil has high salinity (e.g. coastal and estuarine areas or coral sand islands), where the soil quality has been degraded through over-use of fertilizers or lost because of erosion or mining, or in general where arable land is unavailable owing to tenure, purchase costs and land rights. Globally, the arable land suitable for farming is decreasing, and aquaponics is one method that allows people to intensively grow food where in-ground agriculture is difficult or impossible.

6.1.4 Productivity and yield

The most intensive hydroponic culture can achieve 20–25 percent higher yields than the most intensive soil-based culture, although rounded down data by hydroponic experts claim productivity 2–5 times higher. This is when hydroponic culture uses exhaustive greenhouse management, including expensive inputs to sterilize and fertilize the plants. Even without the expensive inputs, the aquaponic techniques described in this publication can equal hydroponic yields and be more productive than soil. The main reason is the fact that soil-less culture allows the farmer to monitor, maintain

and adjust the growing conditions for the plants, ensuring optimal real-time nutrient balances, water delivery, pH and temperature. In addition, in soil-less culture, there is no competition with weeds and plant benefit from higher control of pests and diseases.

6.1.5 Reduced workload

Soil-less culture does not require ploughing, tilling, mulching or weeding. On large farms, this equates to lower reliance on agriculture machinery and fossil fuel usage. In small-scale agriculture, this equates to an easier, less labour-intensive exercise for the farmer, especially because most aquaponic units are raised off the ground, which avoids stooping. Harvesting is also a simple procedure compared with soil-based agriculture, and products do not need extensive cleaning to remove soil contamination. Aquaponics is suitable for any gender and many age classes and ability levels of people.

6.1.6 Sustainable monoculture

With soil-less culture, it is entirely possible to grow the same crops in monoculture, year after year. In-ground monocultures are more challenging because the soil becomes “tired”, loses fertility, and pests and diseases increase. In soil-less culture, there is simply no soil to lose fertility or show tiredness, and all the biotic and abiotic factors that prevent monoculture are controlled. However, all monocultures require a higher degree of attention to control epidemics compared with polyculture.

6.1.7 Increased complication and high initial investment

The labour required for the initial set-up and installation, as well as the cost, can discourage farmers from adopting soil-less culture. Aquaponics is also more expensive than hydroponics because the plant production units need to be supported by aquaculture installations. Aquaponics is a fairly complex system and requires daily management of three groups of organisms. If any one part of the system fails, the entire system can collapse. In addition, aquaponics requires reliable electricity. Overall, aquaponics is far more complicated than soil-based gardening. Once people are familiar with the process, aquaponics becomes very simple and the daily management becomes easier. There is a learning curve, as with many new technologies, and any new aquaponic farmer needs to be dedicated to learn. Aquaponics is not appropriate for every situation, and the benefits should be weighed against the costs before embarking on any new venture.

TABLE 6.1
Summary table comparing soil-based and soil-less plant production

Category		Soil-based	Soil-less
Production	Yield	Variable, depending on soil characteristics and management.	Very high with dense crop production.
	Production quality	Dependent on soil characteristics and management. Products can be of lower quality due to inadequate fertilization/treatments.	Full control over delivery of appropriate nutrients at different plant growth stages. Removal of environmental, biotic and abiotic factors that impair plant growth in soil (soil structure, soil chemistry, pathogens, pests).
	Sanitation	Risk of contamination due to use of low quality water and/or use of contaminated organic matter as fertilizer.	Minimal risk of contamination for human health.
Nutrition	Nutrient delivery	High variability depending on the soil characteristics and structure. Difficult to control the levels of nutrients at the root zone.	Real time control of nutrients and pH to plants at the root zone. Homogeneous and accurate supply of nutrients according to plants' growth stages. Needs monitoring and expertise.
	Nutrient use efficiency	Fertilizers widely distributed with minimum control of nutrients according to growth stage. Potentially high nutrient loss due to leaching and runoff.	Minimal amount used. Uniform distribution and real time adjustable flow of nutrients. No leaching.

TABLE 6.1 (CONTINUED)

Category		Soil-based	Soil-less
Water use	System efficiency	Very sensitive to soil characteristics, possible water stress in plants, high dispersal of nutrients.	Maximized, all water loss can be avoided. Supply of water can be fully controlled by sensors. No labour costs for watering, but higher investment.
	Salinity	Susceptible to salt build up, depending on soil and water characteristics. Flushing salt out uses large amounts of water.	Depends on soil and water characteristics. Can use saline water, but needs salt flush-out that requires higher volumes of water.
Management	Labour and equipment	Standard, but machines are needed for soil treatment (ploughing) and harvesting which rely on fossil fuels. More manpower needed for operations.	Expertise and daily monitoring using relatively costly equipment are both essential. High initial set-up costs. Simpler handling operations for harvest.

6.2 BASIC PLANT BIOLOGY

This section comments briefly on the major parts of the plant and then discusses plant nutrition (Figure 6.3). Further discussion is outside the scope of this publication, but more information can be found in the section on Further Reading.

6.2.1 Basic plant anatomy and function

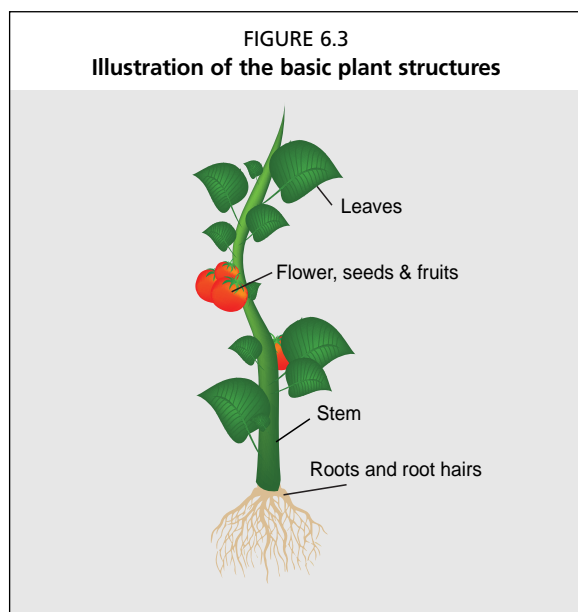

Roots

Roots absorb water and minerals from the soil. Tiny root hairs stick out of the root, helping the absorption process. Roots help to anchor the plant in the soil, preventing it from falling over. Roots also store extra food for future use. Roots in soil-less culture show interesting differences from standard in-ground plants. In soil-less culture, water and nutrients are constantly supplied to the plants, which are facilitated in their nutrient search and can grow faster. Root growth in hydroponics can be significant for the intense uptake and the optimal delivery of phosphorus that stimulates their growth. It is worth noting that roots retain almost 90 percent of the metals absorbed by the plants, which include iron, zinc and other useful micronutrients.

Stems

Stems are the main support structure of the plant. They also act as the plant's plumbing system, conducting water and nutrients from the roots to other parts of the plant, while also transporting food from the leaves to other areas. Stems can be herbaceous, like the bendable stem of a daisy, or woody, like the trunk of an oak tree.

Leaves

Most of the food in a plant is produced in the leaves. Leaves are designed to capture sunlight, which the plant then uses to make food through a process called photosynthesis. Leaves are also important for the transpiration of water.

Flowers

Flowers are the reproductive part of most plants. Flowers contain pollen and tiny eggs called ovules. After pollination of the flower and fertilization of the ovule, the ovule

develops into a fruit. In soil-less techniques, the prompt delivery of potassium before flowering can help plants to have better fruit settings.

Fruit/seeds

Fruits are developed parts of flower ovaries that contain seeds. Fruits include apples, lemons, and pomegranates, but also include tomatoes, eggplants, corn kernels and cucumbers. The latter are considered fruits in a botanical sense because they contain seeds, though in a culinary definition they are often referred to as vegetables. Seeds are the reproductive structures of plants, and fruits serve to help disseminate these seeds. Fruiting plants have different nutrient requirements than leafy green vegetables, especially requiring more potassium and phosphorous.

6.2.2 Photosynthesis

All green plants are designed to generate their own food using the process of photosynthesis (Figure 6.4). Photosynthesis requires oxygen, carbon dioxide, water and light. Within the plant are small organelles called chloroplasts that contain chlorophyll, an enzyme that uses the energy from sunlight to break apart atmospheric carbon dioxide (CO_2) and create high-energy sugar molecules such as glucose. Essential to this process is water (H_2O). This process releases oxygen (O_2), and is historically responsible for all of the oxygen in the atmosphere. Once created, the sugar molecules are transported throughout the plant and used later for all of the physiological processes such as growth, reproduction and metabolism. At night, plants use these same sugars, as well as oxygen, to generate the energy needed for growth. This process is called respiration.

It is vital to locate an aquaponic unit in a place where each plant will have access to sunlight. This ensures adequate energy for photosynthesis. Water should always be available to the roots through the system. Carbon dioxide is freely available from the atmosphere, although in very intensive indoor culture it is possible that plants use all of the carbon dioxide in the enclosed area and require ventilation.

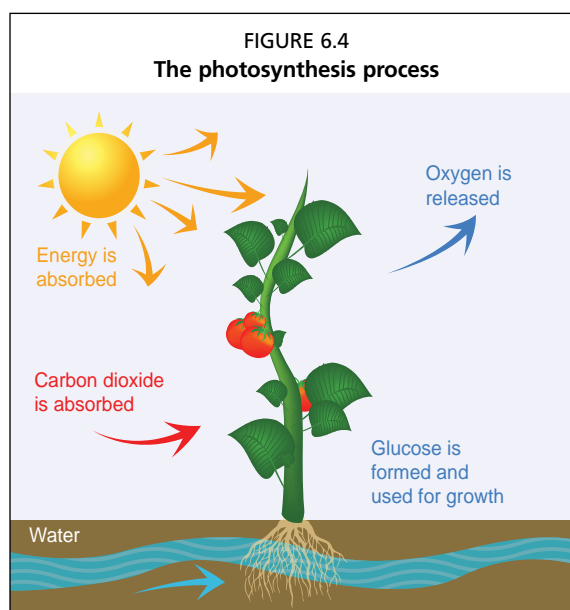

6.2.3 Nutrient requirements

In addition to these basic requirements for photosynthesis, plants need a number of nutrients, also referred to as inorganic salts. These nutrients are required for the enzymes that facilitate photosynthesis, for growth and reproduction. These nutrients can be sourced from the soil. However, in the absence of soil, these nutrients need to be supplied another way. In aquaponics, all of these essential nutrients come from the fish waste.

There are two major categories of nutrients: macronutrients and micronutrients. Both types of nutrient are essential for plants, but in differing amounts. Much larger quantities of the six macronutrients are needed compared with the micronutrients, which are only needed in trace amounts. Although all of these nutrients exist in solid fish waste, some nutrients may be limited in quantity in aquaponics and result in deficiencies, e.g. potassium, calcium and iron. A basic understanding of the function of each nutrient is important to appreciate how they affect plant growth. If nutrient deficiencies occur, it is important to identify which element is absent or lacking in

the system and adjust the system accordingly by adding supplemental fertilizer or increasing mineralization.

Macronutrients

There are six nutrients that plants need in relatively large amounts. These nutrients are nitrogen, phosphorous, potassium, calcium, magnesium and sulphur. The following discussion outlines the function of these macronutrients within the plant. Symptoms of deficiencies are also listed in order to help identify problems.

Nitrogen (N) is the basis of all proteins. It is essential for building structures, photosynthesis, cell growth, metabolic processes and the production of chlorophyll. As such, nitrogen is the most common element in a plant after carbon and oxygen, both of which are obtained from the air. Nitrogen is therefore the key element in the aquaponic nutrient solution and serves as an easy-to-measure proxy indicator for other nutrients. Usually, dissolved nitrogen is in the form of nitrate, but plants can utilize moderate quantities of ammonia and even free amino acids to enable their growth. Nitrogen deficiencies are obvious, and include yellowing of older leaves, thin stems, and poor vigour (Figure 6.5a). Nitrogen can be reallocated within plant tissues and therefore is mobilized from older leaves and delivered to new growth, which is why deficiencies are seen in older growth. An overabundance of nitrogen can cause excess vegetative growth, resulting in lush, soft plants susceptible to disease and insect damage, as well as causing difficulties in flower and fruit set.

Phosphorus (P) is used by plants as the backbone of DNA (deoxyribonucleic acid), as a structural component of phospholipid membranes, and as adenosine triphosphate (the component to store energy in the cells). It is essential for photosynthesis, as well as the formation of oils and sugars. It encourages germination and root development in seedlings. Phosphorous deficiencies commonly cause poor root development because energy cannot be properly transported through the plant; older leaves appear dull green or even purplish brown, and leaf tips appear burnt.

Potassium (K) is used for cell signalling via controlled ion flow through membranes. Potassium also controls stomatic opening, and is involved in flower and fruit set. It is involved in the production and transportation of sugars, water uptake, disease resistance and the ripening of fruits. Potassium deficiency manifests as burned spots on older leaves and poor plant vigour and turgor (Figure 6.5b). Without potassium, flowers and fruits will not develop correctly. Interveinal chlorosis, or yellowing between the veins of the leaves, may be seen on the margins.

Calcium (Ca) is used as a structural component of both cell walls and cell membranes. It is involved in strengthening stems, and contributes to root development. Deficiencies are common in hydroponics and are always apparent in the newest growth because calcium is immobile within the plant. Tip burn of lettuces and blossom-end rot of tomatoes and zucchinis are examples of deficiency. Often, new leaves are distorted with hooked tips and irregular shapes. Calcium can only be transported through active xylem transpiration, so when conditions are too humid, calcium can be available but locked-out because the plants are not transpiring. Increasing air flow with vents or fans can prevent this problem. The addition of coral sand or calcium carbonate can be used to supplement calcium in aquaponics with the added benefit of buffering pH.

Magnesium (Mg) is the centre electron acceptor in chlorophyll molecules and is a key element in photosynthesis. Deficiencies can be seen as yellowing of leaves between the veins especially in older parts of the plant. Although the concentration of magnesium is

sometimes low in aquaponics, it does not appear to be a limiting nutrient, and addition of magnesium to the system is generally unnecessary.

Sulphur (S) is essential to the production of some proteins, including chlorophyll and other photosynthetic enzymes. The amino acids methionine and cysteine both contain sulphur, which contributes to some proteins' tertiary structure. Deficiencies are rare, but include general yellowing of the entire foliage in new growth (Figure 6.5c). Leaves may become yellow, stiff and brittle, and fall off.

Micronutrients

Below is a list of nutrients that are only needed in trace amounts. Most micronutrient deficiencies involve yellowing of the leaves (such as iron, manganese, molybdenum and zinc). However, copper deficiencies cause leaves to darken their green colour.

Iron (Fe) is used in chloroplasts and the electron transport chain, and is critical for proper photosynthesis. Deficiencies are seen as intervenous yellowing, followed by the entire foliage turning pale yellow (chlorotic) and eventually white with necrotic patches and distorted leaf margins. As iron is a non-movable element, iron deficiencies (Figure 6.5d) are easily identified if new leaves appear chlorotic. Iron has to be added as chelated iron, otherwise known as sequestered iron or Fe*EDTA, because iron is apt to precipitate at pH greater than 7. The suggested addition is 5 millilitres per 1 m² of grow bed whenever deficiencies are suspected; a larger quantity does not harm the system, but can cause discolouration of tanks and pipes. It has been suggested that submerged magnetic-drive pumps can sequester iron and is the subject of current research.

Manganese (Mg) is used to catalyse the splitting of water during photosynthesis, and as such, manganese is important to the entire photosynthesis system. Deficiencies manifest as reduced growth rates, a dull grey appearance and intervenous yellowing between veins that remain green, followed by necrosis. Symptoms are similar to iron deficiencies and include chlorosis. Manganese uptake is very poor at pH greater than 8.

Boron (B) is used as a sort of molecular catalyst, especially involved in structural polysaccharides and glycoproteins, carbohydrate transport, and regulation of some metabolic pathways in plants. It is also involved in reproduction and water uptake by cells. Deficiencies may be seen as incomplete bud development and flower set, growth interruption and tip necrosis, and stem and root necrosis.

Zinc (Zn) is used by enzymes and also in chlorophyll, affecting overall plant size, growth and maturation. Deficiencies may be noticed as poor vigour, stunted growth with reduced inter-nodal length and leaf size, and intravenous chlorosis that may be confused with other deficiencies.

Copper (Cu) is used by some enzymes, especially in reproduction. It also helps strengthen stems. Deficiencies may include chlorosis and brown or orange leaf tips, reduced growth of fruits, and necrosis. Sometimes, copper deficiency shows as abnormally dark green growth.

Molybdenum (Mo) is used by plants to catalyse redox reactions with different forms of nitrogen. Without sufficient molybdenum, plants can show symptoms of nitrogen deficiency although nitrogen is present. Molybdenum is biologically unavailable at pH less than 5.

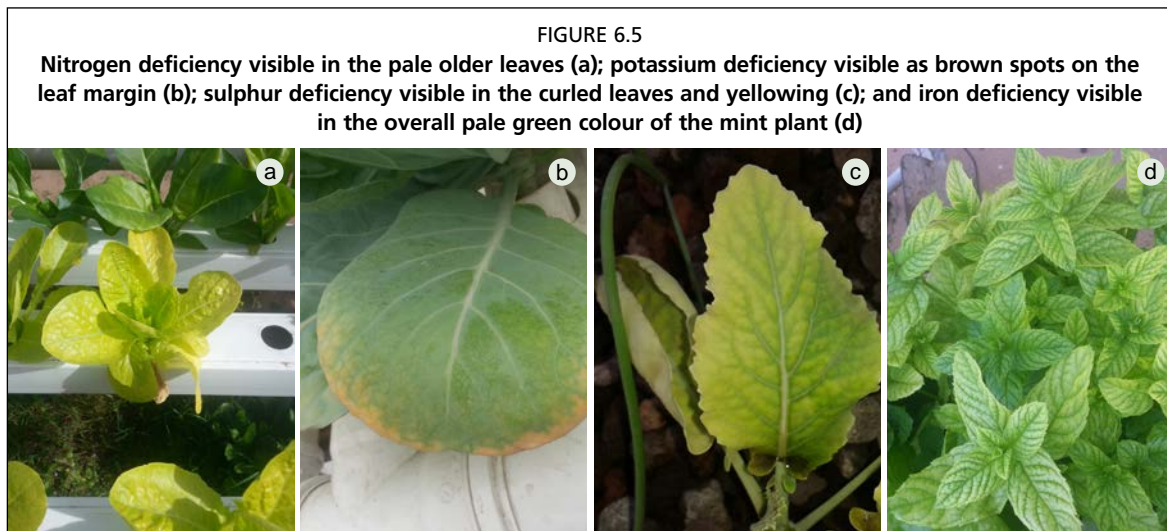

The availability of many of these nutrients depends on the pH (see Section 6.4 for pH-dependent availability), and although the nutrients may be present they may be unusable because of the water quality. For further details on nutrient deficiencies outside the scope of this publication, please refer to the section on Further Reading for illustrated identification guides.

6.2.4 Aquaponic sources of nutrients

Nitrogen is supplied to aquaponic plants mainly in the form of nitrate, converted from the ammonia of fish waste through bacterial nitrification. Some of the other nutrients are dissolved in the water from the fish waste, but most remain in a solid state that is unavailable to plants. The solid fish waste is broken down by heterotrophic bacteria; this action releases the essential nutrients into the water. The best way to ensure that plants do not suffer from deficiencies is to maintain the optimum water pH (6–7) and feed the fish a balanced and complete diet, and use the feed rate ratio to balance the amount of fish feed to plants. However, over time, even an aquaponic system that is perfectly balanced may become deficient in certain nutrients, most often iron potassium or calcium.

Deficiencies in these nutrients are a result of the composition of the fish feed. Fish feed pellets (discussed in Chapter 7) are a complete food for the fish, meaning they provide everything that a fish needs to grow, but not necessarily everything needed for plant growth. Fish simply do not need the same amounts of iron, potassium and calcium that plants require. As such, deficiencies in these nutrients may occur. This can be problematic for plant production, yet there are solutions available to ensure appropriate amounts of these three elements.

In general, iron is regularly added as chelated iron in the aquaponic system to reach concentrations of about 2 mg/litre. Calcium and potassium are added when buffering the water to the correct the pH, as nitrification is an acidifying process. These are added as calcium hydroxide or potassium hydroxide, or as calcium carbonate and potassium carbonate (see Chapter 3 for more details). The choice of the buffer can be chosen based on the plant type being cultivated, as leafy vegetables may need more calcium, and fruiting plants more potassium. In addition, Chapter 9 discusses how to produce simple organic fertilizers from compost to use as supplements to the fish waste, ensuring that the plants are always receiving the right amount of nutrients.

6.3 WATER QUALITY FOR PLANTS

Section 3.3 discussed water quality parameters for the aquaponic system as a whole. Here specific considerations for plants are considered and further expanded.

6.3.1 pH

The pH is the most important parameter for plants in an aquaponic system because it influences a plant's access to nutrients. In general, the tolerance range for most plants is 5.5–7.5. The lower range is below the tolerance for fish and bacteria, and most plants prefer mildly acidic conditions. If the pH goes outside of this range, plants experience nutrient lockout, which means that although the nutrients are present in the water the plants are unable to use them. This is especially true for iron, calcium and magnesium. Sometimes, apparent nutrient deficiencies in plants actually indicate that the pH of the system is outside the optimal range. Figure 6.6 describes the relationship between pH level and the ability for plants to take-up certain nutrients.

However, there is evidence that nutrient lockout is less common in mature aquaponic systems than in hydroponics. Whereas hydroponics is a semi-sterile undertaking, aquaponics is an entire ecosystem. As such, there are biological interactions occurring between the plant roots, bacteria and fungi that may allow nutrient uptake even at higher pH levels than those shown in Figure 6.6. However, the best course of action is to attempt to maintain pH slightly acidic (6–7), but understand that higher pH (7–8) may function. This aspect is the subject of current research.

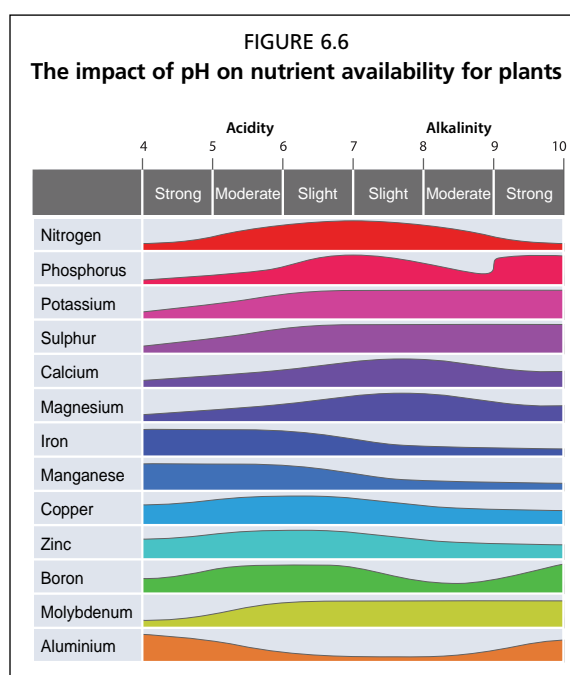

6.3.2 Dissolved oxygen

Most plants need high levels of DO (> 3 mg/litre) within the water. Plants use their stems and leaves to absorb oxygen during respiration, but the roots also need to have oxygen. Without oxygen, the plants can experience root-rot, a situation where the roots die and fungus grows. Some water plants, such as water chestnut, lotus or taro, do not need high levels of DO and can withstand low-oxygen waters such as those in stagnant ponds.

6.3.3 Temperature and season

The suitable temperature range for most vegetables is 18–30 °C. However, some vegetables are far more suited to growing in particular conditions. For the purposes of this publication, winter vegetables require temperatures of 8–20 °C, and summer vegetables require temperatures of 17–30 °C. For example, many leafy green vegetables grow best in cooler conditions (14–20 °C), especially at night. In higher temperatures of 26 °C and above, leafy greens bolt and begin to flower and seed, which makes them bitter and unmarketable. Generally, it is the water temperature that has the greatest effect on the plants rather than the air temperature. Nevertheless, care should be taken in the correct choice of plants and fish to meet their optimal water temperature ranges. Another aspect of seasonal planting is that some plants require a certain amount of daylight to produce flowers and fruit, which is called photoperiodism. Some, referred to as short-day plants, require a certain amount of darkness before flowering. This signal to the plant indicates that winter is approaching, and the plant puts its energy into reproduction instead of growth. Some commonly grown, short-day plants include varieties of peppers and certain medicinal flowers. On the other hand, long-day plants require a certain day length before producing flowers, although this is

rarely a consideration in vegetables but may be so for some ornamentals. As such, it is important to follow the local seasonal planting practices for each vegetable grown or to choose varieties that are neutral to photoperiodism. Appendix 1 contains further details on individual vegetables.

6.3.4 Ammonia, nitrite and nitrate

As explained in Chapter 2, plants are able to take up all three forms of nitrogen, but nitrate is the most accessible. Ammonia and nitrite are very toxic to fish and should always be maintained below 1 mg/litre. In a functioning aquaponic unit, ammonia and nitrite are always 0–1 mg/litre and should not be a problem for the plants.

6.4 PLANT SELECTION

To date, more than 150 different vegetables, herbs, flowers and small trees have been grown successfully in aquaponic systems, including research, domestic and commercial units. Appendix 1 provides a technical summary of, and detailed growing instructions for, the 12 most popular herbs and vegetables. In general, leafy green plants do extremely well in aquaponics along with some of the most popular fruiting vegetables, including tomatoes, cucumbers and peppers. Fruiting vegetables have higher nutrient demands and are more appropriate for established systems with adequate fish stocks. However, some root crops and some sensitive plants do not grow well in aquaponics. Root crops require special attention, and they can only be grown successfully in deep media beds, or a version of wicking beds discussed in more detail in Section 9.3.

Vegetables vary regarding their overall nutrient demand. There are two general categories of aquaponic plants based on this demand. Low-nutrient-demand plants include the leafy greens and herbs, such as lettuce, chard, salad rocket, basil, mint, parsley, coriander, chives, pak choi and watercress. Many of the legumes such as peas and beans also have low-nutrient demands. At the other end of the spectrum are plants with high-nutrient demand, sometimes referred to as nutrient hungry. These include the botanical fruits, such as tomatoes, eggplants, cucumbers, zucchini, strawberries and peppers. Other plants with medium nutrient demands are: cabbages, such as kale, cauliflower, broccoli and kohlrab. Bulbing plants such as beets, taro, onions and carrots have medium to high requirements, while radish requires less nutrients.

The style of grow bed influences the choice of plants. In media bed units, it is common practice to grow a polyculture of leafy greens, herbs and fruiting vegetables at the same time (Figure 6.7). Provided media bed units are the right depth (at least 30 cm), it is possible to grow all the vegetables mentioned in the categories above. Polyculture on small surfaces can also take advantage of companion planting (see Appendix 2) and better space management, because shade-tolerant species can grow underneath taller plants. Monoculture practices are more prevalent in commercial NFT and DWC units because the grower is restricted by the number of holes in the pipes and rafts in which to plant vegetables. Using NFT units, it might be possible to grow the larger fruiting vegetables, such as tomatoes, but these plants need to have access to copious amounts of water to secure sufficient supply of nutrients and to avoid water stress. Wilting in fruiting plants can in fact occur almost immediately if the flow is disrupted, with devastating effects on the whole crop. Fruiting plants also need to be planted in larger grow pipes, ideally with flat bottoms, and be positioned over a larger distance than leafy vegetables. This is because fruiting plants grow larger and need more light to ripen their fruits and also because there is limited root space in the pipes. On the other hand, large bulb and/or root crops, such as kohlrabi, carrots and turnips, are more likely to be cultured in media beds because NFT and DWC units do not provide a good growing environment and adequate support to the plants.

It is important to consider the effect of harvesting the plants on the entire ecosystem. If all of the plants were to be harvested at once, the result would be an unbalanced system

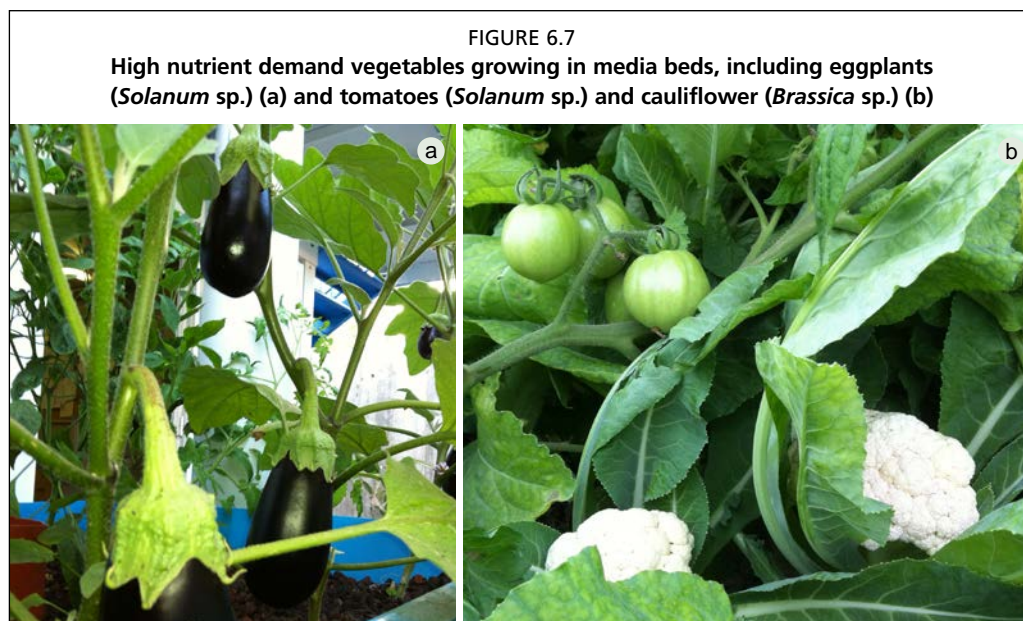

without enough plants to clean the water, resulting in nutrient spikes. Some farmers use this technique, but it must correspond with a large fish harvest or a reduction of the feed ration. However, the recommendation here is to use a staggered harvesting and replanting cycle. The presence of too many plants growing synchronously would result in the systems being deficient in some nutrients towards the harvest period, when the uptake is at a maximum. By having plants at different life stages, i.e. some seedlings and some mature, the overall nutrient demand is always the same. This ensures more stable water chemistry, and also provides a more regular production both for the home table and the market. Staggered planting schemes are discussed in more detail in Chapter 8.

6.5 PLANT HEALTH, PEST AND DISEASE CONTROL

Plant health has a broad meaning that goes far beyond just the absence of illnesses; it is the overall status of well-being that allows a plant to achieve its full productive potential. Plant health, including disease prevention and pest deterrence and removal, is an extremely important aspect of aquaponic food production (Figure 6.8). Although the most important advances in plant health have been achieved through the management of pathogens and pests, optimal nutrition, intelligent planting techniques and proper environmental management are also fundamental to secure healthy plants. In addition, knowledge on the specific plants grown is fundamental to addressing various production issues. Although some basic concepts on plant nutrition have already been

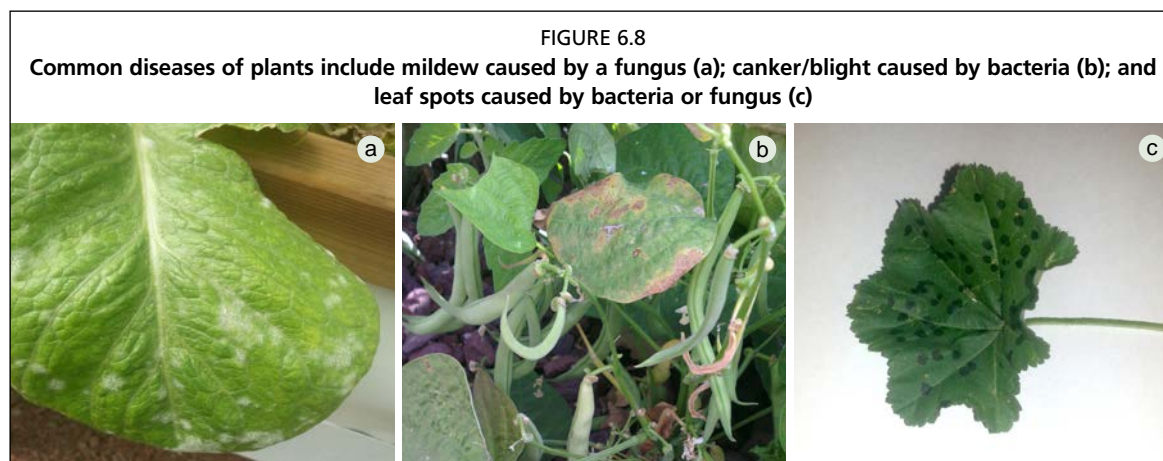

described, this section aims to provide a far greater understanding on how to minimize the risks and to address plant diseases and pests in small-scale aquaponics.

For more information on beneficial insects, including insect characteristics and climatic needs, along with general information on pest identification, as well as integrated pest and disease management (including different products available for treatment), see Appendix 2 and the resources listed in the section on Further Reading.

6.5.1 Plant pests, integrated production and pest management

Insect pests are problematic for plant production because they carry diseases that plants can contract. Pests also extract liquids as they bore into plant tissues, leading to stunted growth. Controlled environments, such as greenhouses, can be particularly problematic for pests because the enclosed space provides favourable conditions for insects without rain or wind. Pest management for outdoor conditions also differs from that in protected cultivation (net houses, greenhouses), due to the physical separation of the plants from the surrounding area, which allows the use of beneficial insects indoor to kill/control the insect pests. Insect pest prevalence is also highly dependent on climate and environment. Pest management in temperate or arid zones is easier than in tropical regions, where higher incidence and competition among insects make pest control a far more difficult task.

As aquaponic units maintain an independent ecosystem, it is normal for a host of micro-organisms and small insects and spiders to exist within the media beds. However, other harmful insect pests, such as whiteflies, thrips, aphids, leaf miners, cabbage moths and spider mites feed upon and damage the plants. A common practice for dealing with problematic insect pests in soil vegetable production is to use chemical pesticides or insecticides, but this is **impossible** in aquaponics. Any strong chemical pesticide could be fatal for fish as well as the beneficial bacteria living in system. Therefore, commercial chemical pesticides must never be used. However, there are other effective physical, environmental and cultural controls to reduce the threat of pests from aquaponics. Insecticides and deterrents should be considered a last resort. Nevertheless, successful management integrates crop and environmental management with the use of organic and biological pest deterrents.

Integrated production and pest management (IPPM) is an ecosystem approach to soil-based and soil-less plant production and protection that combines different management strategies and practices to grow healthy plants and minimize pesticide use. It is a combination of mechanical, physical, chemical, biological and microbial controls along with host-plant resistance and cultural practices. Not all of these controls are applicable for aquaponics as some may be fatal for fish and bacteria (i.e. chemical and some organic pesticides) while others may not be economically justified for small-scale aquaponics (i.e. microbial control agents). Thus, this section concentrates on the most applicable strategies for small-scale aquaponics, including mechanical and physical control, host plant resistance and cultural techniques to prevent the threat of pests and diseases. Some brief comments are given on some aquaponic-safe biological controls (i.e. beneficial insects and microorganisms), and more details are included in Appendix 2. For further information on these methods, see the section on Further Reading.

Physical, mechanical and cultural controls

For pest management in aquaponics, prevention is fundamental. Regular and thorough monitoring for pests is vital, and, ideally, minor infestations can be identified and managed before the insects damage the entire crop. Below is a list of simple inexpensive controls used in organic/conventional agriculture, which are also suitable for small-scale aquaponics, to avoid pest infestations. Physical exclusion refers to keeping the pests away. Mechanical removal is when the farmer actively takes the pests away from

the plants. Cultural controls are the choices and management activities that the farmer can undertake to prevent pests. These controls should be used as a first line of defence against insect pests before other methods are considered.

Netting/screens

This method is common to prevent pest damage in tropical regions or wherever organic horticulture is practised or pesticides are not effective. Netting mesh size varies depending on the pest targeted; use nets with a mesh size of 0.15 mm to exclude thrips, 0.35 mm to exclude whitefly and aphids, and 0.8 mm to keep out leaf miners. Netting is particularly effective while the seedlings are very young and tender. Screens do not suppress or eradicate pests, they only exclude most of them; therefore, they must be installed prior to pest appearance and care should be taken not to let pests enter into the protected environment.

Physical barriers

Given the limited distances that insects can cover, it is possible to reduce pest prevalence by adding physical barriers between the vegetables and the surrounding vegetation such as paved surfaces or building stories. Rooftop aquaponic production benefits from the natural ventilation, given the higher altitude, and the large physical barrier (distance from the ground) creating ideal conditions for outdoor production relatively free from pests and diseases (Figure 6.9). Greenhouses often have a strong fan blowing out through the entrance way that can help to prevent insects from entering with the farmer.

Another useful technique is to create a barrier on the legs of the hydroponic containers. A ring of copper flashing can prevent snails and slugs from climbing up the legs, and a coating of petroleum jelly can prevent ants. Placing the bottom of the legs in a container of water can also prevent ants.

Hand inspection and removal

The removal, either by hand or using a high-pressured stream of water, of heavily infested leaves or plants helps to avoid and/or to delay the spread of insects to surrounding plants (Figure 6.10). Larger pests and larvae may also be used as supplementary food for the fish. Water sprayed from a hose directed at the underside of the leaves is an extremely effective management technique on many types of sucking insects. The stream can actually kill some insects, and the others are washed away. This is effective on sucking insects such as aphids and whiteflies. This is one of the most effective methods on small-scale systems, but it can be just a temporary remedy as the displaced pests can return to the plants. It can use significant volumes of water and become too labour-intensive with larger systems.

Trapping

Sticky traps positioned slightly above the canopy of plants are effective in protected environments

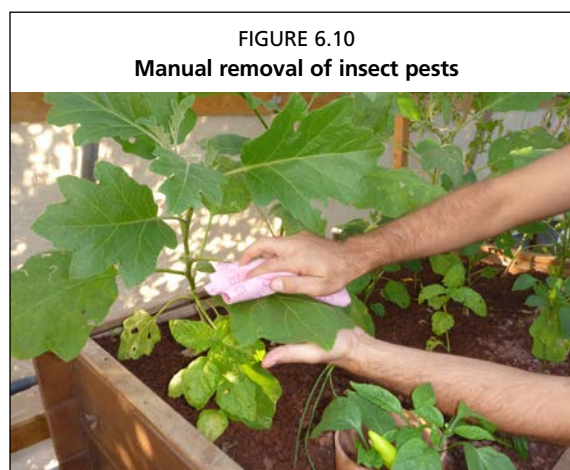



(e.g. net houses, greenhouses). Blue sticky cards trap adult stages of thrips while yellow sticky cards trap whiteflies and microlepidoptera (Figure 6.11). Sticky traps are less effective in outdoor conditions as new insects can easily come from the surrounding areas. The continuous monitoring of insects being captured by the traps can help a farmer to adopt specific measures to reduce the occurrence of certain pests. Another effective way of dealing with pests is to use pheromone-baited traps. These attract males of specific pests, thereby reducing the mating population in the area.

Environmental management

Maintain optimal light, temperature and humidity conditions, which can be easily changed in protected cultivation, to favour healthier plant growth and to build unfavourable conditions for pests. For example, spider mites do not tolerate wet and humid conditions, so timed misters directed on the plant leaves can deter infestations.

Plant choice

Some pests are more attracted to specific plant species than others. Similarly, different plant varieties from the same species have different resistance/tolerance to pests. This is one reason that polyculture can often prevent large infestations because some plants remain unaffected. Moreover, some plants attract and retain more beneficial insects to help manage pest populations (discussed in more detail below). Choose resistant varieties from local suppliers and agriculture extension agents to help reduce diseases and infestations.

Indicator plants and sacrificial/catch/trap crops

Some plants, such as cucumber and legumes, are more prone to aphids or red mite infestations and thus can be used to detect pest prevalence early. Often, indicator plants are planted along the exterior edge of larger gardens. Another strategy that can be adopted in aquaponics is the use of biological insecticides on sacrificial or “catch plants” planted near to, but not within, the aquaponic system. Catch plants (i.e. fava beans) attract pests. These plants can be grown in pots beside the aquaponic unit, attracting the pests away from the unit, which are then treated with insecticides (see below). This strategy would not affect the aquaponic ecosystem or beneficial insects present around the unit. Although not purely organic, catch plants can even be treated with commercial synthetic insecticides if large infestations are present. Fava beans and petunias (flowers) can be used to catch thrips, aphids and mites. Cucumbers are also used to catch aphids and hoppers while succulent lettuce seedlings are used to capture other leaf-eating insects.

Companion planting

Companion planting is the constructive use of plant relationships by growers. For example, all plants produce natural chemicals that they release from their leaves, flowers and roots. These chemicals may attract or repel certain insects and can enhance or limit the growth rate and yield of neighbouring plants. It is therefore important to be aware of which plants benefit from each other when planted together, and which plant combinations are best avoided. Appendix 2 provides a companion planting table to use when choosing crops. When using the companion table, concentrate on avoiding the bad companions rather than planning for good ones. Some plants release chemicals from their roots or leaves that either suppress or repel pests, which can serve to protect other neighbouring plants.

Fertilization

As mentioned above, excessive nitrogen makes plants more prone to pest attack because they have more succulent tissues. A correct balance of nutrients using the feed rate ratio (see Chapters 2 and 8) helps plants to grow stronger in order to withstand pest attacks. Some water should be exchanged when nitrate levels are greater than 120 mg/litre for this reason.

Spacing

High planting density and/or inadequate pruning increases competition for light, encouraging insect pests. This competition eventually makes plant tissue more succulent for pests to bore through or for pathogens to penetrate, and the cramped conditions offer shelter to the pests. Be sure that there is adequate ventilation and sunlight penetration through the canopy. As previously discussed, many plants have special needs for sunlight or a lack of it. By combining full-sun with shade-tolerant plants, it is possible to intensify the production without the risk of raising competition and weakening the plants. In this case shade-tolerant plants can grow under the canopy of sun-loving ones. In this way, the plants are healthier and more resistant to pests and disease.

Crop rotation

Although aquaponic units can be managed as monoculture without facing problems of soil tiredness (depletion of nutrients naturally present in soil), growing the same species continuously over multiple seasons can have a selective effect on the surrounding pests. Thus, a change in crop, even for a short period, may cause a drastic reduction of pests specifically targeting the monoculture crop.

Sanitation

The removal of all plant debris, including all roots, at the end of each harvest helps to reduce the incidence of pests and diseases. Dead leaves and diseased branches should be removed consistently. In outdoor conditions without nets, it is advisable to reduce the surrounding vegetation to a minimum in order to prevent pests spreading to the aquaponic unit. Diseased plants and compost piles should be kept far from the system to prevent contamination.

Chemical controls

If pests remain a problem after using the above physical, mechanical and cultural controls, it may be necessary to use chemical control. Synthetic pesticides and insecticides must never be used in aquaponics because they will kill the fish. Many biological controls are also deadly to fish. All chemical controls are to be considered a last resort in aquaponic systems and only used sparingly. If possible, such as for DWC systems, it is better to remove and treat the plants away from the system and allow the

chemicals to dry completely. Appendix 2 contains a list of common insecticides and repellents, their indications and their relative toxicity to fish.

Biological controls

As for botanical pesticides, some extracts obtained from micro-organisms are safe for aquatic animals because they act specifically on insect structures and do not harm mammals or fish. Two organisms widely used in aquaponics and organic agriculture are *Bacillus thuringiensis* and *Beauveria bassiana*. The former is a toxin extract from a bacterium that damages the insect's digestive tract and kills it. It can be sprayed on leaves and specifically targets caterpillars, leaf rollers, moth or butterfly larvae without damaging other beneficial insects. *B. bassiana* is a fungus that germinates and penetrates the insect's skin (chitin), killing the pest through dehydration. The efficacy of the fungus depends on the number of spores sprayed and on the optimal humidity and temperature conditions, ideally a good agent for humid tropics.

Beneficial insects – pest predators

Finally, beneficial insects are another effective method to control pests, particularly in controlled environments such as greenhouses or nethouses. Beneficial or predator insects such as lacewings are introduced into the plant growing space in order to control any further infestation. Some of the advantages of using beneficial insects include: the absence of pesticide residue or pesticide-induced resistance in pests, economically feasible (in the long run for large-scale operations only), and ecologically sound. However, successful pest control using this method depends on detailed knowledge of each beneficial insect along with the constant monitoring of pests to time correctly the introduction of beneficial insects. Moreover, beneficial insects can be attracted naturally to outdoor systems. Many of these beneficial insects feed on nectar in their adult stages, so a selection of flowers near the aquaponic unit can maintain a population that can keep pests in balance.

It is important to underline that this method of control never fully eradicates the pests. Instead, pests are suppressed under a tight prey-predator relationship. This method has already been used with positive results for large-scale aquaponics, yet for small-scale aquaponics there may not be enough pests for the beneficial insects to predate, which may lead them to fly away. The choice of beneficial insects to use (see Appendix 2) should take into account the environmental conditions where they are going to operate.

6.5.2 Plant diseases and integrated disease management

Unlike hydroponics, which is mostly managed under sterile conditions, aquaponics takes advantage of a complex microscopic ecosystem that includes bacteria, fungi and other micro-organisms. The presence of these well adapted micro-organisms makes each system more resilient in the event of attack by pests or diseases. Nevertheless, successful plant production is the result of management strategies to avoid disease outbreaks that mainly focus on the environmental conditions, pest deterrence (pests such as whitefly may carry lethal viruses) on plant management as well as the use of organic remedies that help to prevent or to cure the plants. Similar to IPPM, integrated disease management relies on prevention, plant choice, and monitoring as a first line of defence against disease, and uses targeted treatment only when necessary.

Environmental controls

Temperature and humidity play an important role in the health management of plants. Each plant pathogen (i.e. bacteria, fungi or parasites; Figure 6.8) has optimal growth temperatures that can be different to those of plants. Thus, diseases occur in certain areas and periods during the year when conditions are more favourable to the pathogen than

to its host. Moreover, moisture plays a key role for the germination of fungal spores, which require a thin film of water covering the plant tissues. Similarly, the activation of some bacterial and fungal diseases is strictly correlated with the presence of surface water. Therefore, the control of relative humidity and moisture are essential in order to reduce the risks of disease outbreaks. Appendix 2 contains detailed environmental conditions that encourage several common fungal diseases.

Control of relative humidity, especially in greenhouse aquaponics, is particularly important. This can be achieved through dynamic or forced ventilation by means of windows and fans creating horizontal airflow helping to minimize temperature differentials and cold spots where condensation occurs. Moving air is continually mixed, which prevents the temperature dropping below the dew point; therefore, water does not condense on the vegetables.

Evaporation from fish tanks and/or aerated DWC canals housed in greenhouses should also be avoided by physically covering the water surfaces, as evaporated water can dramatically increase the indoor humidity. Pipes in NFT units are prone to high water temperatures in hot seasons because of the continuous exposure to the sun on the pipes. Media bed systems are an optimal compromise, given the right choice of medium, because the top surfaces of the beds are always kept dry (see Chapter 4). Finally, systems built on rooftops have the advantage of a drier microclimate and good ventilation compared with ground level, which facilitates environmental management of plants.

Control of water temperature plays a key role in avoiding fungal outbreaks. A very common disease in aquaponics is root rot caused by *Pythium* spp., a soil-borne pathogen that can be accidentally introduced into the system from contaminated materials (soil, peat, seedlings from nurseries). Unlike in hydroponics, in aquaponics this fungus does not cause damage below certain temperatures because of the competitive presence of other micro-organisms. The maintenance of temperatures below 28–30 °C is thus essential in order to avoid the exponential germination of spores that would eventually cause an outbreak.

Attention should also be given to planting densities. Very high densities reduce the internal ventilation and increase the humidity among the plants. The risk of diseases for densely planted crops is also enhanced as, under intense light competition, plants grow without consolidating their cells, leading to softer and more succulent tissues walls. Tender tissues are more prone to disease because of their limited resistance to pest and/or pathogen penetration.

Plant choice

Plant varieties have different levels of resistances to pathogens. In some cases, using known resistant cultivars is the most successful method of avoiding disease. Thus, it is vital to select plant varieties that are more adapted to grow in certain environments or have a higher degree of resistance against a particular pathogen. Moreover, many seed companies offer a wide selection of plants that have different responses against pathogens. The use of local varieties that are naturally selected for a specific environment can ensure healthy plant growth.

If it is not possible to control certain diseases with resistant varieties, it is wise to shift to other crops during the critical season. In the case of *Pythium* spp. if resistant varieties of lettuce and beneficial micro-organisms are not able to control the infestation, it is opportune to shift to other species, such as basil, that are more tolerant to the pathogen and to high water temperatures.

Seeds and/or seedlings must be bought from a reputable nursery that employs effective disease prevention strategies and can secure disease-free products. Moreover, avoid injury to plants, as broken branches, cracks, cuts and pest damage often lead to diseases breaking out in the same area.

Plant nutrition

Nutrition greatly affects a plant's susceptibility to disease. It also affects a plant's ability to respond against disease using different mechanisms, including antixenosis (processes to deter colonization by herbivores) or antibiosis (processes to kill or reduce herbivores after landing or during eating). A correct balance of nutrients not only provides optimal growth but also makes plants less susceptible to diseases. Although the description of nutritional disorders has been discussed above, Table 6.2 outlines how some nutrients can play a major role in disease occurrence.

TABLE 6.2
Effect of nutrients on fungal disease prevention

Nutrient	Effect
Nitrogen	Overfertilization makes more succulent tissues that are more prone to fungal attack. Nitrogen starvation makes stunted plants more prone to attacks from opportunistic micro-organisms.
Potassium	Accelerates wound healing and reduces the effect of frost damage. Delays maturity and senescence of plants.
Phosphorus	Improves nutrient balances and accelerates the maturity of the plants.
Calcium	Reduces the severity of some root and stem fungal diseases. Affects the cell wall composition in plants that resists fungal penetration.
Silicon	Helps plants to produce specific defence reactions, including the release of phenolic compounds against pathogens.

Source: Agrios (2004).

Monitoring – inspection and exclusion

Early detection and intervention is the foundation of disease and pest management. Thus, plants should be inspected regularly for early signs of infection or pest presence that may result in infection. Whenever plants show signs of damage or initial stages of disease (wilt, blight or root rot), it is vital to remove the infected branches, leaves or the whole plant to avoid the disease spreading throughout the entire crop. Moreover, regarding exclusion, it is important to enforce the control of potential vectors (sources) of viruses, such as whiteflies, by growing plants in insect-proof structures (see Section 6.5.1). In addition, the avoidance of soil contamination as well as the use of disinfected tools (e.g. shears used for pruning/harvesting) would help to avoid the transmission of potential pathogens into the system. Finally, it is good practice to monitor and record all symptoms and the progression of each disease in order to determine the best prevention and treatment methods in the future.

Treatment – inorganic or chemical

As mentioned above, aquaponics is a complex ecosystem that is more resilient than hydroponics to soil-borne disease. However, some disease outbreaks may still occur in the case of unfavourable environmental conditions, such as higher relative humidity in greenhouses or in tropical climates, and need to be controlled. As aquaponics is an integrated system containing fish, plants and beneficial micro-organisms, it is not possible to use the standard disease treatments of conventional agriculture (i.e. chemical fungicides) as they are toxic to fish. However, common practices used for organic agriculture are possible, provided that they do not harm fish and/or the bacteria or do not accumulate in the system leading to higher than accepted thresholds. Appendix 2 indicates elements and methods of application used in organic agriculture that can also be used for aquaponics to fight and stave off different diseases. In general, successful treatment using the methods relies on the combination of a few strategies that can have synergic effect against specific pathogens.

Treatment – biological

Some biological control agents can be used for aquaponics such as *Thricoderma* spp., *Ampelomices* spp. and *Bacillus subtilis*, which are cultured micro-organisms used to

fight against specific diseases. These biological agents can be applied either on leaves or at the root zone. They provide protection against the most common soil-borne diseases including downy mildew, powdery mildew and some bacteria. In particular, *Trichoderma* spp. have proved effective in controlling *Pythium* spp. and most of the soil-borne pathogens, while *Ampelomices* spp. could offset any need for inorganic or chemical treatments against powdery mildew. In the case of *Trichoderma* spp., the spores can be distributed on substrate when seeding, to let the beneficial fungus protect plants starting at their seedling stage. Product information, producers and distributors should be consulted before use in order to identify the best treatment methods for specific diseases.

For more detailed information on specific vegetable diseases including identification, susceptibility and prevalence, see recommended texts in the section on Further Reading.

6.6 PLANTING DESIGN

The layout of the grow beds helps to maximize plant production in the available space. Before planting, choose wisely which plants will be grown, bearing in mind the space needed for each plant and what the appropriate growing season is. A good practice for all garden design is to plan the layout of the grow beds on paper in order to have a better understanding of how everything will look. Important considerations are: plant diversity, companion plants and physical compatibility, nutrient demands, market demands, and ease of access. For example, taller crops (i.e. tomatoes) should be placed in the most accessible place within the media bed to make harvesting easier.

Encouraging plant diversity

In general, planting various crops and varieties provides a degree of security to the grower. All plants are susceptible to some kinds of disease or parasites. If only one crop is grown, the chance for a serious infestation or epidemic is higher. This can unbalance the system as a whole. As such, growers are encouraged to plant a diverse range of vegetables in small-scale units (Figure 6.12).

Staggered planting

As mentioned previously, it is important to stagger planting. In this way there can be constant harvest and replanting, which helps to maintain a balanced level of nutrients in the unit. At the same time, it provides a steady supply of plants to the table or market. Keep in mind that some plants produce fruit or leaves that can be harvested continually throughout a season, such as salad leaf varieties, basil, coriander and tomatoes, whereas some other crops are harvested whole, such as kohlrabi, lettuce, carrots. To achieve staggered planting there should always be a ready supply of seedlings (the development of a plant nursery is discussed in Chapter 8).

Maximizing space in media beds

Not only should the surface area be planned out to maximize space, but also the vertical space and time should be considered. For example, in regard to time, plant vegetables with short grow-out periods (salad greens) between plants with longer-term crops (eggplant). The benefit of this practice is that the salad greens can be harvested first and provide more room as the eggplants mature. Continued replanting of tender vegetables such as lettuce in between large fruiting plants provides naturally shaded conditions.

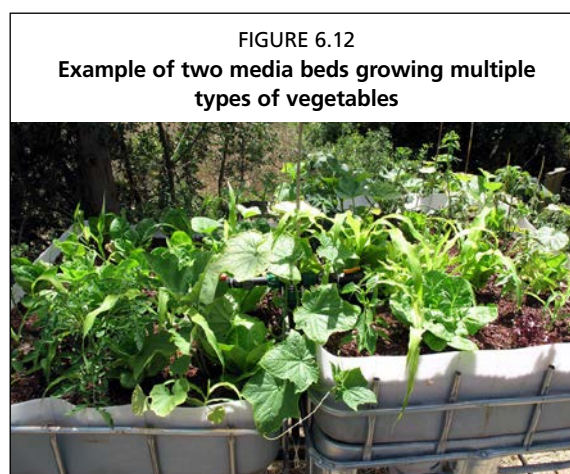

Make sure that the shaded crops are not completely dominated as the large crops mature. Vegetables such as cucumbers are natural climbers that can be trained to grow up or down and away from the beds. Use wooden stakes and/or string to help support the climbing vegetables. This creates more space in the media bed (Figure 6.13). One of the benefits of aquaponics is that plants can be easily moved by gently freeing the roots from the growing media and placing the plant in a different spot.

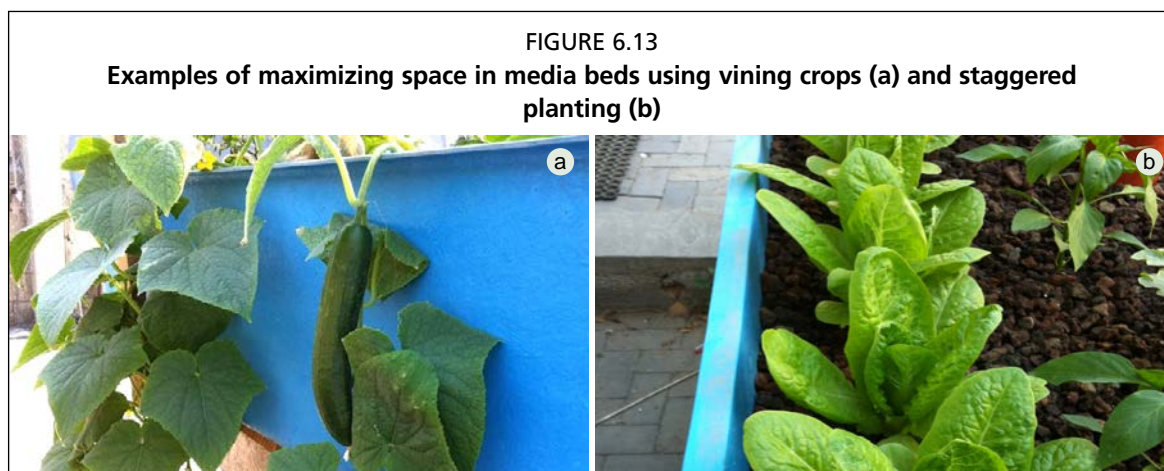

6.7 CHAPTER SUMMARY

- The major advantages of aquaponics over soil agriculture are: (i) no wasted fertilizer; (ii) lower water use; (iii) higher productivity/quality; (iv) ability to utilize non-arable land; and (v) offset of tillage, weeding and other traditional agricultural tasks.
- Plants require sunlight, air, water and nutrients to grow. Essential macronutrients include: nitrogen, phosphorus, potassium, calcium, magnesium and sulphur; Micronutrients include iron, zinc, boron, copper, manganese and molybdenum. Deficiencies need to be addressed by supplying the limiting nutrients with supplemental fertilizer or increasing mineralization.
- The most important water quality parameter for plants is pH because it affects the availability of essential nutrients.
- The suitable temperature range for most vegetables is 18–26 °C, although many vegetables are seasonal. Winter vegetables require temperatures of 8–20 °C, and summer vegetables require temperatures of 17–30 °C.
- Leafy green herbs and vegetables do extremely well in aquaponics. Large fruiting vegetables are also applicable, including tomatoes, peppers, eggplant, and cucumbers, peas and beans. Root crops and tubers are less commonly grown and require special attention.
- Integrated production and pest/disease management uses physical, mechanical and cultural practices to minimize pests/pathogens, and then uses fish-safe chemical and biological treatment in targeted applications, when necessary.
- Intelligent planting design can maximize space, encourage beneficial insects and improve production.
- Staggered planting provides continual harvest as well as a constant nutrient uptake and more consistent water quality.

7. Fish in aquaponics

The first section in this chapter includes select information on fish anatomy and physiology, including how they breathe, digest food and excrete wastes. The feed conversion ratio (FCR) is introduced, important for all aquaculture, which refers to how efficiently the fish convert feed into body mass. Special attention is then devoted to the fish life cycle and reproduction as it relates to breeding and maintaining stocks. The care and health of fish in aquaponic units are then discussed, covering water quality, oxygen, temperature, light and nutrition. The third section identifies a number of suitable commercial aquatic species for aquaponics, focusing on tilapia, carp, catfish, trout, bass and prawns (Figure 7.1). The chapter closes with a final section on individual fish health, diseases and disease prevention methods.

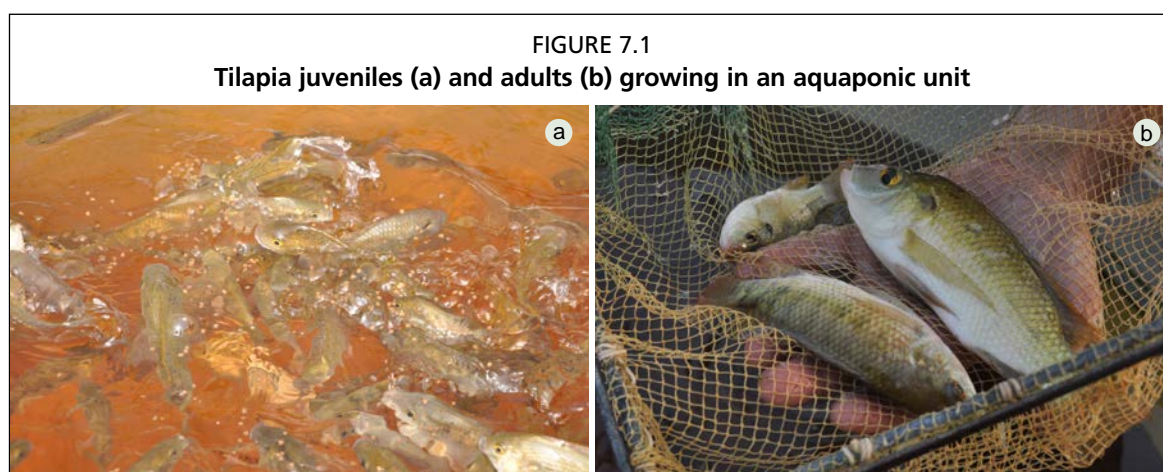

7.1 FISH ANATOMY, PHYSIOLOGY AND REPRODUCTION

7.1.1 Fish anatomy

Fish are a diverse group of vertebrate animals that have gills and live in water. A typical fish uses gills to obtain oxygen from the water, while at the same time releasing carbon dioxide and metabolic wastes (Figure 7.2). The typical fish is ectothermic, or cold-blooded, meaning that its body temperature fluctuates according to the water temperature. Fish have almost the same organs as terrestrial animals; however, they also possess a swim bladder. Positioned in the abdomen, this is a vesicle containing air that keeps the animal neutrally buoyant in the water. Most fish use fins for movement and have a streamlined body for navigating through water. Often, their skin is covered with protective scales. Most fish lay eggs. Fish have well-developed sensory organs allowing them to see, taste, hear, smell and touch. In addition, most fish have lateral lines, which sense pressure differences in the water. Some groups can even detect electrical fields, such as those created by heartbeats of prey species. However, their central nervous system is not as well developed as in birds or mammals.

Main external anatomical features

Eyes – Fish eyes are very similar to those of terrestrial animals, such as birds and mammals, except their lenses are more spherical. Some fish, such as trout and tilapia, rely on sight to find prey while other species use mainly their sense of smell.

Scales – Scales provide protection for the fish by acting as a shield against predators, parasites, diseases and physical abrasion.

Mouth and jaws – Fish ingest food through the mouth and break it down in the gullet. Often, the mouth is relatively large, allowing the ingestion of substantial prey. Some fish have teeth, including sometimes on the tongue. Fish breathe by bringing water in through the mouth and expelling it through the operculum.

Gill cover/operculum – This is the external covering of the gills, which offers protection to these delicate organs. It is often a bony plate and can be seen opening and closing while the fish is breathing.

Vent – This is the external opening on the bottom of the body near the tail. Solid wastes and urine pass through the digestive track, through the anus, and are expelled through the vent. In addition, the vent is where reproductive gametes (sperm and eggs) are released. The vent has a similar function to a cloaca.

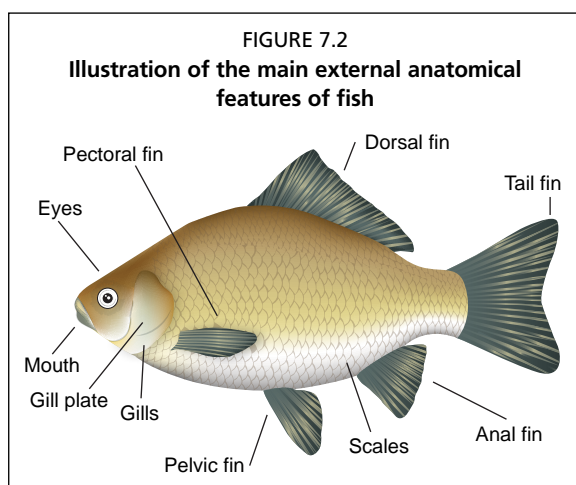

Fins – Paired fins, both the pectoral fins and pelvic fins, are located on the bottom of the fish body. They provide manoeuvrability and steering control. Odd fins, the dorsal fins and anal fins can be found on the top and bottom of the body and provide balance and stability as well as steering control. The tail fin is at the opposite end from the head and provides the main propulsion and movement for the fish. Fins often have sharp spines, sometimes with attached poison sacs, that are used for defence.

Respiration

Fish breathe oxygen using their gills, which are located in each side of the head area. Gills consist of structures called filaments. Each filament contains a blood vessel network that provides a large surface area for the exchange of oxygen and carbon dioxide. Fish exchange gases by pulling oxygen-rich water through their mouths and pumping it over their gills, releasing carbon dioxide at the same time. In their natural habitat, oxygen is supplied either by aquatic plants that produce oxygen through photosynthesis or from water movements such as waves and wind that dissolve atmospheric oxygen into the water. Without adequate DO, most fish suffocate and die. That is why adequate aeration is so crucial to successful aquaculture. However, some fish are equipped with an air breathing organ, similar to lungs, that allows them to breathe out of water. Clariidae catfish are one such group of fish that are important in aquaculture.

Excretion

Nitrogen wastes are created as fish digest and metabolize their feed. These wastes come from the breaking down of proteins and the reuse of the resulting amino acids. These nitrogenous wastes are toxic to the body and need to be excreted. Fish release these wastes in three ways. First, ammonia diffuses into the water from the gills. If ammonia levels are high in the surrounding water, the ammonia does not diffuse as readily, which can lead to ammonia accumulation in the blood and damage to internal organs. Second, fish produce large quantities of very dilute urine that is expelled through their vents. Some nitrogen (proteins, amino acids, ammonia) is also present in the solid wastes that

are expelled through the vent. Fish use kidneys to filter their blood and concentrate the waste for disposal. The excretion of urine is an osmotic regulation process, helping fish to maintain their salt content. Freshwater fish do not need to drink, and in fact need to actively expel water to maintain physiologic balance.

7.1.2 Fish reproduction and life cycle

Almost all fish lay eggs that develop outside of the mother's body; indeed, 97 percent of all known fish are oviparous. Fertilization of the eggs by the sperm, known as milt in fish biology, also occurs externally in most cases. Male and female fish both release their sex cells into the water. Some species maintain nests and provide parental care and protection of the eggs, but most species do not attend the fertilized eggs which simply disperse into the water column. Tilapias are one example of fish that have extensive parental care, taking the time to maintain nests and actually brood the young fry in the mouth of the females. The reproductive organs of fish include testes, which make sperm, and ovaries, which make eggs. Some fish are hermaphrodites, having both testes and ovaries, either simultaneously, or at different phases in their life cycle.

For the purposes of this publication, an average fish will pass through the life stages of egg, larvae, fry, fingerling, grow-out (adult fish) and sexual maturity (Figure 7.3). The duration of each of these stages is dependent on the species. The egg stage is often fairly brief and usually depends on water temperature. During this stage, the eggs are delicate and sensitive to physical damage. In culture conditions, the water needs to have adequate DO, but the aeration must be gentle. Sterile procedures and good hatchery practices prevent bacterial and fungal diseases of unhatched eggs. Once hatched, the young fish are called larvae. These small fish are usually poorly formed, carry a large yolk sac, and are often very different in appearance from juvenile and adult fish. The yolk sac is used for nourishment, and it is absorbed throughout the larval stage, which is also fairly short depending on temperature. At the end of the larval stage, when the yolk sac is absorbed and the young fish begin to swim more actively and move to the fry stage.

At the fry and fingerling stage, fish begin to eat solid food. In the wild, this food is generally plankton found in the water column and algae from the substrate. During these stages, fish are voracious eaters, eating about 10 percent of their body weight per day. As the fish continue to grow, the percentage body weight of food per day decreases. The exact demarcations between fry, fingerlings and adult fish differ between species and between farmers. Generally, fry, fingerlings and juvenile fish need to be kept separate to prevent the larger fish from eating the smaller individuals. The grow-out stage is the stage that aquaponics typically focuses on because this is when the fish are eating, growing and excreting wastes for the plants. Most fish are harvested during the grow-out stage. If fish are allowed to grow past this stage, they begin to reach sexual maturity, where their physical growth slows down as the fish devote more energy into the development of sex organs. Some mature fish need to be kept to complete the cycle during breeding operations, and these fish are often referred to as broodstock. Tilapias are exceptionally easy breeders, and can in fact breed too much for a small-scale system. Catfish, carp and trout require more careful management, and it may be better to source fish from a reputable supplier. It is outside the scope

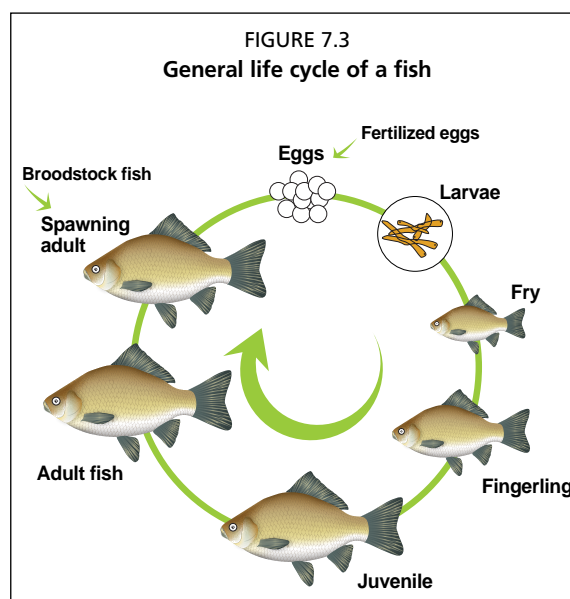

of this publication to detail aquaculture breeding techniques, but please refer to the section on Further Reading for helpful sources.

7.2 FISH FEED AND NUTRITION

7.2.1 Components and nutrition of fish feed

Fish require the correct balance of proteins, carbohydrates, fats, vitamins and minerals to grow and be healthy. This type of feed is considered a whole feed. Commercially available fish feed pellets are highly recommended for small-scale aquaponics, especially at the beginning. It is possible to create fish feed in locations that have limited access to manufactured feeds. However, these home-made feeds need special attention because they are often not whole feeds and may lack in essential nutritional components. More on homemade feeds can be found in Section 9.11 and Appendix 5.

Protein is the most important component for building fish mass. In their grow-out stage, omnivorous fish such as tilapia and common carp need 25–35 percent protein in their diet, while carnivorous fish need up to 45 percent protein in order to grow at optimal levels. In general, younger fish (fry and fingerlings) require a diet richer in protein than during the grow-out stage. Proteins are the basis of structure and enzymes in all living organisms. Proteins consist of amino acids, some of which are synthesized by the fishes' bodies, but others which have to be obtained from the food. These are called essential amino acids. Of the ten essential amino acids, methionine and lysine are often limiting factors, and these need to be supplemented in some vegetable-based feeds.

Lipids are fats, which are high-energy molecules necessary to a fish's diet. Fish oil is a common component of fish feeds. Fish oil is high in two special types of fats, omega-3 and omega-6, that have health benefits for humans. The amount of these healthy lipids in farmed fish depends on the feed used.

Carbohydrates consist of starches and sugars. This component of the feed is an inexpensive ingredient that increases the energy value of the feed. The starch and sugars also help to bind the feed together to make a pellet. However, fish do not digest and metabolize carbohydrates very well, and much of this energy can be lost.

Vitamins and minerals are necessary for fish health and growth. Vitamins are organic molecules, synthesized by plants or through manufacturing, that are important for development and immune system function. Minerals are inorganic elements. These minerals are necessary for the fish to synthesis their own body components (bone), vitamins and cellular structures. Some minerals are also involved in osmotic regulation.

7.2.2 Pelletized fish feed

There are a number of different sizes of fish feed pellets, ranging from 2 to 10 mm (Figure 7.4). The recommended size of these pellets depends on the size of the fish. Fry and fingerlings have small mouths and cannot ingest large pellets, while large fish waste energy if the pellets are too small. If possible, the feed should be purchased for each stage of the lifecycle of the fish. Alternatively, large pellets can be crushed with a mortar and pestle to create powder for fry and crumbles for fingerlings. Another method is to always use medium-sized pellets (2–4 mm). This way, fish are able to eat the same-sized pellet from the fingerling stage right up to maturity.

Fish feed pellets are also designed to either float on the surface or sink to the bottom of the tank, depending on the feeding habits of the fish. It is important to know the eating behaviour of the specific fish and supply the correct type of pellet. Floating pellets are advantageous because it is easy to identify how much the fish are eating. It is often possible to train fish to feed according to the food pellets available; however, some fish will not change their feeding culture.

Feed should be stored in dark, dry, cool and secure conditions. Warm wet fish feed can rot, being decomposed by bacteria and fungi. These micro-organisms can release

toxins that are dangerous to fish; spoiled feed should never be fed to fish. Fish feed should not be stored for too long and should be purchased fresh and used immediately to conserve the nutritional qualities, wherever possible.

Avoid overfeeding

Uneaten food waste should never be left in the aquaponic system. Feed waste from overfeeding is consumed by heterotrophic bacteria, which consume substantial amounts of oxygen. In addition, decomposing food can increase the amount of ammonia and nitrite to toxic levels in a relatively short period. Finally, the uneaten pellets can clog the mechanical filters, leading to decreased water flow and anoxic areas. In general, fish eat all they need to eat in a 30 minute period. After this length of time, remove any food. If uneaten food is found, lower the amount of feed given the next time. Further feeding strategies are discussed in Section 8.4.

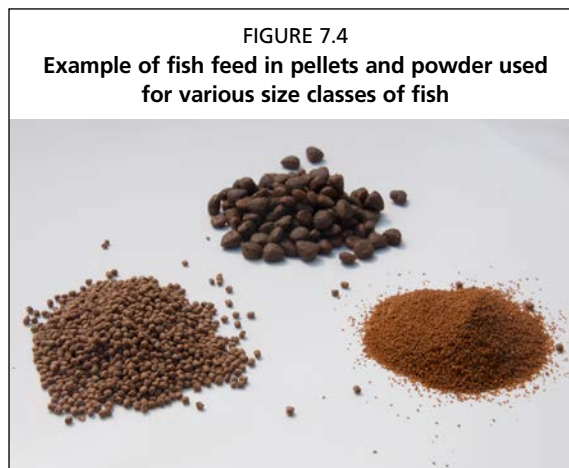

7.2.3 Feed conversion ratio for fish and feeding rate

The FCR describes how efficiently an animal turns its food into growth. It answers the question of how many units of feed are required to grow one unit of animal – FCRs exist for every animal and offer a convenient way to measure the efficiency and costs of raising that animal. Fish, in general, have one of the best FCRs of all livestock. In good conditions, tilapias have an FCR of 1.4–1.8, meaning that to grow a 1.0 kg tilapia, 1.4–1.8 kg of food is required.

Tracking FCR is not essential in small-scale aquaponics, but it can be useful to do in some circumstances. When changing feeds, it is worth considering how well the fish grow in regard to any cost differences between the feeds. Moreover, when considering starting a small commercial system, it is necessary to calculate the FCR as part of the business plan and/or financial analysis. Even if not concerned about the FCR, it is good practice to periodically weigh a sample of the fish to make sure they are growing well and to understand the balance of the system (Figure 7.5). This also provides a more accurate growth rate expectation for harvest timing and production. As with all fish handling, weighing is easier in darkness to avoid stressing the fish. Box 3 lists simple steps for weighing fish. Weighing fish of the same age growing in the same tank is in general more preferable than heterogeneous cohorts of fish because the measurement should provide more reliable averages.

BOX 3

Simple steps for weighing fish

- 1) Fill a small bucket (10 litres) with water from the aquaponic system.
- 2) Weigh the bucket and water using a weighing scale and record the weight (tare).
- 3) Scoop 5 average size fish with a landing-net, drain the landing-net from excess of water for a few seconds and place the fish into the bucket.
- 4) Weigh again and record the gross weight.
- 5) Calculate the total weight of the fish by subtracting the tare from the gross weight.
- 6) Divide this figure by 5 to retrieve an average weight for each fish.
- 7) Repeat steps 1–6 as appropriate. Try to measure 10–20 percent of the fish (preferably no duplicates) for an accurate average.



Periodical weight measurements will give the average growth rate of the fish, which will be obtained by subtracting the average fish weight, calculated above, over two periods.

The FCR is obtained by dividing the total feed consumed by the fish by the total growth during a given period, with both values expressed in the same weight unit (i.e. kilogram, gram).

$$\text{Total feed} / \text{Total growth} = \text{FCR}$$

The total feed can be obtained by summing all the recorded amount of feed consumed each day. The total growth can be calculated by simply multiplying the average growth rate by the number of the fish stocked in the tank.

At the grow-out stage, the feeding rate for most cultured fish (as discussed in this publication) is 1–2 percent of their body weight per day. On average, a 100 gram fish eats 1–2 grams of pelletized fish feed per day. Monitor this feeding rate at the same time as the FCR to determine growth rates and fish appetite and to help maintain overall system balance

7.3 WATER QUALITY FOR FISH

Chapter 2 discussed water quality for aquaponics. Here, the most important water quality parameters are listed again briefly and summarized in Table 7.1.

7.3.1 Nitrogen

Ammonia and nitrite are extremely toxic to fish, and sometimes referred to as “invisible assassins”. Ammonia and nitrite are both considered toxic above levels of 1 mg/litre, although any level of these compounds contributes to fish stress and adverse health effects. There should be close to zero detectable levels of both of these in a seasoned aquaponic system. The biofilter is entirely responsible for transforming these toxic chemicals into a less toxic form. Any detectable levels indicate that the system is unbalanced with an undersized biofilter or that the biofilter is not functioning properly. Ammonia is more toxic in warm basic conditions; if the pH is high, any detectable amount of ammonia is especially dangerous. Water tests for ammonia are called total ammonia nitrogen (TAN), and test for both types of ammonia (ionized and un-ionized). Symptoms of ammonia and nitrite poisoning are often seen as red streaking on the fish body, gills and eyes, scraping on the sides of the tank, gasping at the surface for air, lethargy and death. Nitrate on the other hand is much less toxic to most fish. Most species are able to tolerate levels of more than 400 mg/litre.

7.3.2 pH

Fish can tolerate a fairly wide range of pH, but do best at levels of 6.5–8.5. Substantial changes in pH in short periods (changes of 0.3 within a period of 12–24 hours) can be problematic or even lethal for fish. Therefore, it is important to keep the pH as stable as possible. Buffering with carbonate is recommended to prevent large pH swings.

7.3.3 Dissolved oxygen

Overall, as much DO as possible should be added to the aquaponic system. In practice, most fish require 4–5 mg/litre. Most domestic growers do not have the ability to check

the oxygen level in their units because digital oxygen meters are expensive and cheaper aquarium test kits are not widely available. Even so, following these recommendations ensures adequate DO levels. Do not overstock the fish, and refrain from adding more than 20 kg of fish per 1 000 litres of total water. Dynamic water flow, with cascading water falling back into the system, helps to aerate the water and add DO. Air pumps, if at all feasible, should be used. The suggested rate is 5–8 litres of air per minute for each cubic metre of water, coming from at least 2 air stones in different locations in the fish tank. Densely stocked units may require considerably more. Make sure that the water is not churned too vigorously or in a way that disrupts the fish swimming.

A clear sign for lack of oxygen is when fish are gasping for air at the surface. This behaviour, called piping, is when fish swim close to the surface of the water and take air into their mouths. This is an emergency situation that needs immediate attention. Backup (redundant) aeration systems are a valuable asset to an aquaponic system and can be used during power outages and equipment failures; simple battery backups for air pumps have saved countless fish throughout the industry.

7.3.4 Temperature

Fish are cold-blooded and, therefore, their ability to adjust to a large range of water temperatures is low. A steady temperature within their correct tolerance range keeps fish in their optimal conditions and aids fast growth and efficient FCR. In addition, optimal temperatures (and thus less stress) reduce the risk of diseases. Thermal isolation, water heaters and coolers help to achieve a steady temperature level, although these may be costly in areas where energy is expensive. It is often better to grow fish adapted to local environmental conditions. Each fish has an optimum temperature range that should be researched by the farmer. Generally, tropical fish thrive at 22–32 °C while cold-water fish prefer 10–18 °C. Meanwhile some temperate water fish have wide ranges, for example, common carp and largemouth bass can tolerate 5–30 °C.

7.3.5 Light and darkness

The light level in the fish tank should be reduced to prevent algae growth. However, it should not be completely dark, as fish experience fear and stress when a completely dark tank is exposed to sudden light when uncovered. The ideal condition is with indirect natural light through shading, which would both prevent algal growth and avoid stress to fish. It is also recommended to handle, harvest or grade fish in darkness to reduce fish stress to a minimum.

TABLE 7.1

Water quality parameters, feed requirement and expected growth rates for seven commercial aquatic species commonly used in aquaponics

Species	Temperature (°C)		Total ammonia nitrogen (mg/litre)	Nitrite (mg/litre)	Dissolved oxygen (mg/litre)	Crude protein in feed (%)	Growth-rate (Grow-out stage)
	Vital	Optimal					
Common carp <i>Cyprinus carpio</i>	4–34	25–30	< 1	< 1	> 4	30–38	600 grams in 9–11 months
Nile tilapia <i>Oreochromis niloticus</i>	14–36	27–30	< 2	< 1	> 4	28–32	600 grams in 6–8 months
Channel catfish <i>Ictalurus punctatus</i>	5–34	24–30	< 1	< 1	> 3	25–36	400 grams in 9–10 months
Rainbow trout <i>Oncorhynchus mykiss</i>	10–18	14–16	< 0.5	< 0.3	> 6	42	1 000 grams in 14–16 months
Flathead mullet <i>Mugil cephalus</i>	8–32	20–27	< 1	< 1	> 4	30–34	750 grams in 9–11 months
Giant river prawn <i>Macrobrachium rosenbergii</i>	17–34	26–32	< 0.5	< 2	> 3	35	30 grams in 4–5 months
Barramundi <i>Lates calcarifer</i>	18–34	26–29	< 1	< 1	> 4	38–45	400 grams in 9–10 months

7.4 FISH SELECTION

Several fish species have recorded excellent growth rates in aquaponic units. Fish species suitable for aquaponic farming include: tilapia, common carp, silver carp, grass carp, barramundi, jade perch, catfish, trout, salmon, Murray cod, and largemouth bass. Some of these species, which are available worldwide, grow particularly well in aquaponic units and are discussed in more detail in the following sections. In planning an aquaponic facility it is critical to appreciate the importance of the availability of healthy fish from reputable local suppliers.

Some cultured fish have been introduced to areas outside of their natural habitat, such as tilapia and a number of carp and catfish species. Many of these introductions have been through aquaculture. It is also important to be aware of local regulations governing the importation of any new species. Exotic (i.e. non-native) species should never be released into local bodies of water. Local extension agents should be contacted for more information regarding invasive species and native species suitable for farming.

7.4.1 Tilapia

Main commercial types:

- Blue tilapia (*Oreochromis aureus*)
- Nile tilapia (*Oreochromis niloticus*)
- Mozambique tilapia (*Oreochromis mossambicus*)
- Various hybrids combining these three species.

FIGURE 7.6
Line drawing and photograph of a Nile tilapia (*Oreochromis niloticus*)

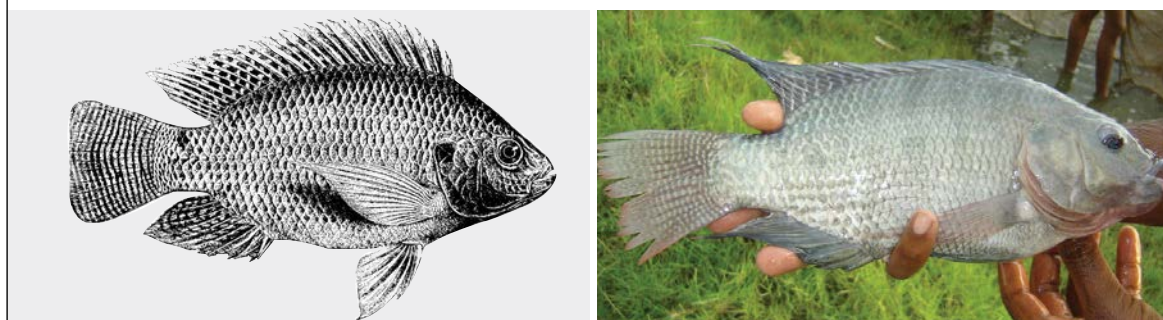

Description

Native to East Africa, tilapias are one of the most popular freshwater species to grow in aquaculture systems worldwide (Figure 7.6). They are resistant to many pathogens and parasites and handling stress. They can tolerate a wide range of water quality conditions and do best in warm temperatures. Although tilapias briefly tolerate water temperatures extremes of 14 and 36 °C, they do not feed or grow below 17 °C, and they die below 12 °C. The ideal range is 27–30 °C, which ensures good growth rates. Therefore, in temperate climates, tilapias may not be appropriate for winter seasons unless the water is heated. An alternate method for cool climates is to grow multiple species throughout the year, rearing tilapias during the warmest seasons and switching to carp or trout during the winter. In ideal conditions, tilapias can grow from fingerling size (50 g) to maturity (500 g) in about 6 months.

Tilapias are omnivores, meaning they eat both plant- and animal-based feed. Tilapias are candidates for many alternative feeds, discussed in Section 9.1.2. Tilapias have been fed duckweed, *Azolla* spp., *Moringa olifera* and other high-protein plants, but care must be used to ensure a whole feed (i.e. nutritionally complete). Tilapias eat other fish, especially their own young; when breeding, the tilapia should be separated by

size. Tilapias less than 15 cm eat smaller fish, though when larger than 15 cm they are generally too slow and cease to be a problem.

Tilapias are easy to breed in small-scale and medium-scale aquaponic systems. More information is available in the section on Further Reading, but a brief discussion is outlined below. One method is to use a large aquaponic system for the grow-out stage. Two smaller separate fish tanks can then be used to house the broodstock and juveniles. Small separate aquaponic systems can be used to manage the water quality in these two tanks, but may not be necessary with a low stocking density. Broodstock fish are hand-selected adults that are not harvested, and they are chosen as healthy specimens for breeding. Tilapias breed readily, especially where the water is warm, oxygenated, algae-filled and shaded, and in a calm and quiet environment. Rocky substrate on the bottom encourages nest building. The optimal ratio of males to females also encourages breeding; often, 2 males are paired with 6–10 females to initiate spawning. Tilapia eggs and fry are seen either in the mouths of the females or swimming on the surface. These fry can be transferred into juvenile rearing tanks, ensuring that no larger fingerlings are present that will eat them, and grown until they are large enough to enter the main culture tanks.

Tilapias can be aggressive, especially in low densities, because males are territorial. Therefore, the fish should be kept at high densities in the grow-out tanks. Some farms only use male fish in the grow-out tanks; all male cultures of the same age grow larger and faster, because males do not divert energy in developing ovaries and do not stop feeding when spawning eggs as females do. Moreover, the growth rate in all-male tanks is not reduced by competition for food from fry and fingerlings, which are continuously produced if sexually mature males and females are left growing together. Monosex male tilapia can be obtained through hormone treatment or hand sexing of fingerlings. In the first case, fry are fed a testosterone-enriched feed during their first three weeks of life. High levels of the hormone in the blood cause a sex reversal in female fry. This technique, widely used in Asia and America but not in Europe (owing to different regulations), allows farmers to stock same-size male tilapia in ponds in order to avoid any problems of spawning and growth depression by feed competition from newer juveniles.

Hand sexing simply consists of separating males from females by looking at their genital papilla when fish are about 40 g or larger. The process of identification is quite straightforward. In the vent region the males have only a single opening whereas females have two slits. The vent of the female is more “C” shaped, while in males the papilla is more triangular. As the fish grow larger, secondary characteristics can help identify males from females. Male fish have larger heads with a more pronounced forehead region, a humped back and more squared-off features. Females are sleeker and have smaller heads. Moreover, the fish’s behaviour can indicate the sex because males chase other males away and then court the females. Hand-sexing can be performed with small numbers of fish, as it does not take much time. However, this technique may not be practical in large-scale systems owing to the large numbers of fish being cultured. Nevertheless, mixed-sex tilapia can be reared in tanks until fish reach sexual maturity at the age of five months. Although females are relatively underperforming, they still do not cause problems with spawning and can be harvested at an earlier stage (200 g or more), leaving the males to grow further.

7.4.2 Carp

Main commercial types:

- Common carp (*Cyprinus carpio*)
- Silver carp (*Hypophthalmichthys molitrix*)
- Grass carp (*Ctenopharyngodon idella*)

FIGURE 7.7
Line drawing and photograph of a grass carp (*Ctenopharyngodon idella*)



Description

Native to eastern Europe and Asia, carps are currently the most cultured fish species globally (Figure 7.7). Carp, like tilapia, are tolerant to relatively low DO levels and poor water quality, but they have a much larger tolerance range for water temperature. Carp can survive at temperatures as low as 4 °C and as high as 34 °C making them an ideal selection for aquaponics in both temperate and tropical regions. Best growth rates are obtained when temperatures are between 25 °C and 30 °C. In these conditions, they can grow from fingerling to harvest size (500-600 g) in less than a year (10 months). Growth rates dramatically decrease with temperatures below 12 °C. Male carp are smaller than females, yet can still grow up to 40 kg and 1–1.2 m in length in the wild.

In the wild, carps are bottom-feeding omnivores that eat a large range of foods. They have a preference for feeding on invertebrates such as water insects, insect larvae, worms, molluscs and zooplankton. Some herbivorous carp species also eat the stalks, leaves and seeds of aquatic and terrestrial plants, as well as decaying vegetation. Cultured carp can be easily trained to eat floating pellet feed.

Carp fingerlings are best obtained from hatcheries and dedicated breeding facilities. The procedure to obtain juveniles is more complicated than tilapia because spawning in female carps is induced by hormone injection, a technique requiring additional knowledge of fish physiology and experience.

Carps can easily be polycultured and this has been done for centuries. It mainly consists in culturing herbivorous fish (grass carp), planktivorous fish (silver carp) and omnivorous/detritivorous fish (common carp) together in order to cover all the food niches. In aquaponics, the combination of these three species, or at least grass carp with common carp, would result in a better use of food, as the former would feed on both pellet and crop residues while the latter would also seek for wastes accumulating at the bottom of the tank. The supply of roots, among other crop residues, would be also

extremely beneficial to the nutrient pool in the aquaponic system, because their digestion by the fish and the successive waste mineralization would return most of the micronutrients back to the plants.

FIGURE 7.8
Ornamental fish (*Cyprinus carpio*) in aquaponic system



Other carp species (ornamental fish)

Gold or Koi carps are mainly produced for the ornamental fish industry rather than food fish (Figure 7.8). These fish also have a high tolerance to a variety of water conditions and therefore are good candidates for an aquaponic system. They can be sold to individuals and aquarium stores for considerably more money

than fish sold as food. Koi carps and other ornamental fish are a popular choice for vegetarian aquaponic growers.

Beyond the climatic characteristics and fish management issues, the choice of a carp species to be cultured in aquaponics should follow a cost–benefit analysis that takes into account the convenience in culturing a fish that is bonier and generally fetches lower market prices than other species.

7.4.3 Catfish

Main commercial types:

Channel catfish (*Ictalurus punctatus*)

African catfish (*Clarias gariepinus*)

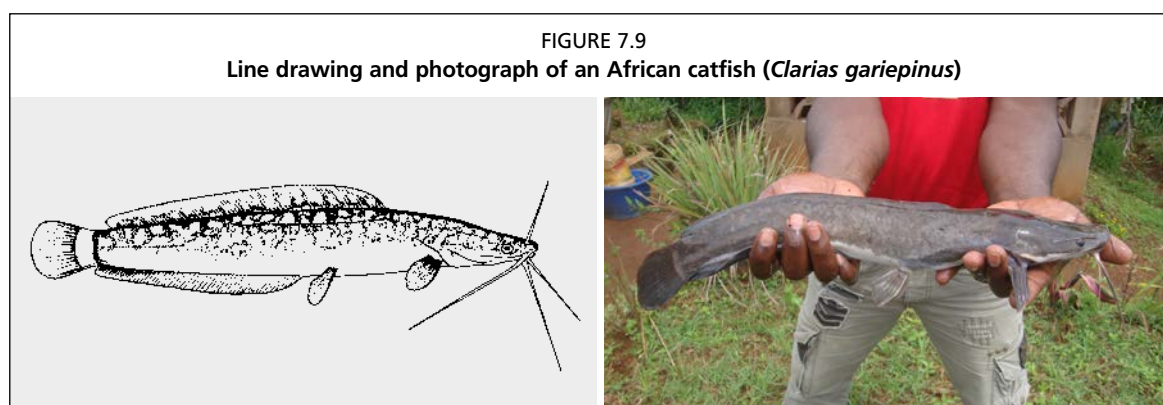

Description

Catfish are an extremely hardy group of fish tolerating wide swings in DO, temperature and pH (Figure 7.9). They are also resistant to many diseases and parasites, making them ideal for aquaculture. Catfish can be easily stocked at very high densities, up to 150 kg/m³. These stocking densities require comprehensive mechanical filtration and solids removal beyond that discussed in this publication. The African catfish is one of many species in the Clariidae family. These species are air breathers, making them ideal for aquaculture and aquaponics as a sudden and dramatic drop in DO would not result in any fish mortalities. Catfish are the easiest species for beginners or for aquaponists who want to grow fish in areas where the supply of electricity is not reliable. Given the high tolerance to low DO levels and high ammonia levels, catfish can be stocked at higher densities, provided there is adequate mechanical filtration. Regarding waste management, it is worth noting that suspended solid waste produced by catfish is less voluminous and more dissolved than that of tilapia, a factor that facilitates greater mineralization. Like tilapia, catfish grow best in warm water and prefer a temperature of 26 °C; but in the case of African catfish growth stops below 20–22 °C. The physiology of catfish is different from other fish, as they can tolerate high levels of ammonia, but, according to recent literature, nitrate concentrations of more than 100 mg/litre may reduce their appetite due to an internal regulatory control triggered by high levels of nitrate in their blood.

Catfish are benthic fish, meaning they occupy only the bottom portion of the tank. This can cause difficulties in raising them at high densities because they do not spread out through the water column. In overcrowded tanks, catfish can hurt each other with their spines. When raising catfish, one option is to use a tank with greater horizontal space than vertical space, thereby allowing the fish to spread out along the bottom. Alternatively, many farmers raise catfish with another species of fish that utilize the upper portion of the tank, commonly bluegill sunfish, perch or tilapia. Catfish can be trained to eat floating pellets.

7.4.4 Trout

Main commercial type:

Rainbow trout (*Oncorhynchus mykiss*)

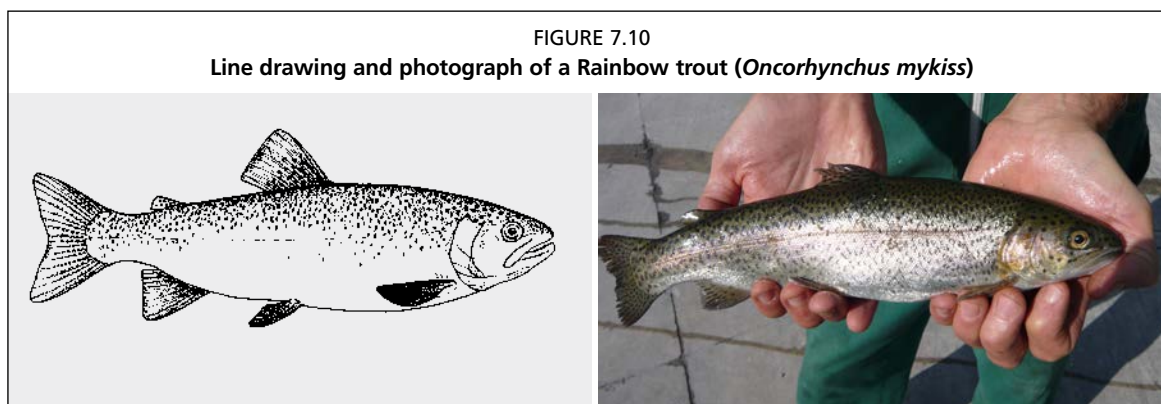

Description

Trout are carnivorous cold-water fish that belong to the salmon family (Figure 7.10). All trout require colder water than the other species previously mentioned, preferring 10–18 °C with an optimum temperature of 15 °C. Trout are ideal for aquaponics in Nordic or temperate climate regions, especially in winter. Growth rates significantly decrease as temperatures increase above 21 °C; above this temperature trout may not be able to properly utilize DO even if available. Trout require a high protein diet compared with carp and tilapia meaning greater amounts of nitrogen in the overall nutrient pool per unit of fish feed added. This occurrence allows for more cultivable areas of leafy vegetables while maintaining a balanced aquaponic unit. Trout have a very high tolerance to salinity, and many varieties can survive in freshwater, brackish water and marine environments. Overall, trout require better water quality than tilapia or carp, particularly with regard to DO and ammonia. Successful aquaculture of trout also requires frequent water quality monitoring as well as backup systems for air and water pumps.

Rainbow trout is the most common trout species grown in aquaculture systems in the United States of America and Canada and in sea cages or flow-through tanks and ponds in central or northern Europe (Norway, Scotland [the United Kingdom]), in parts of South America (Chile, Peru), in many upland areas in tropical and subtropical Africa and Asia (Islamic Republic of Iran, Nepal, Japan) and Australia. Rainbow trout are long, thin and scale-less fish, usually blue-green and spotted on top with a red stripe on the sides. Trout are also cultured and released into streams and lakes to supplement sport fishing.

Trout require a high-protein diet with substantial amount of fats. Trout are considered an “oily fish”, a nutritional description indicating a high amount of vitamin A, vitamin D and omega-3 fatty acid, making them an excellent choice to grow for domestic consumption. Trout command higher prices in some markets for the same reason, but they require diets comparatively rich in fish oil.

7.4.5 Largemouth bass

Main commercial type:

Largemouth bass (*Micropterus salmoides*)

Description

Largemouth bass are native to North America but are widely spread throughout the world, occurring in many water bodies and ponds (Figure 7.11). They belong to the

FIGURE 7.11
Line drawing and photograph of a largemouth bass (*Micropterus salmoides*)



order Perciformes (perch-like fish) which also includes striped bass, Australian bass, the black sea bass, the European sea bass and many others.

Largemouth bass tolerates a wide temperature range as growth will only cease at less than 10 °C or more than 36 °C; they will stop feeding at temperatures less than 10 °C. The optimal growth temperatures are in the range of 24–30 °C for all fish stages. They tolerate low DO and pH, although for a good FCR the optimal DO is above 4 mg/litre.

Largemouth bass prefer clean water with a concentration of suspended solids less than 25 mg/litre, yet growth has been observed in ponds with turbidity as high as 100 mg/litre. As with trout, largemouth bass are carnivorous fish, demanding high protein diets; thus size cohorts should be separated to prevent the consumption of fry and very small juveniles by larger fish. Growth rates are highly dependent on temperature and quality of feed; in temperate climates most of the growth is obtained during the warmer seasons (late spring, summer and early fall). Given their high tolerance to DO as well as good resistance to high nitrite levels, largemouth bass are an excellent choice for aquaponic farmers, particularly for those who cannot change species between cold and warm seasons. Attempts have been carried out to culture this species in polyculture with tilapia. Nutritionally speaking, largemouth bass contain relatively high levels of omega-3 fatty acids compared with other freshwater fish.

7.4.6 Prawns

Main commercial type:

Giant river prawn (*Macrobrachium rosenbergii*)

FIGURE 7.12
Line drawing and photograph of a giant river prawn (*Macrobrachium rosenbergii*)

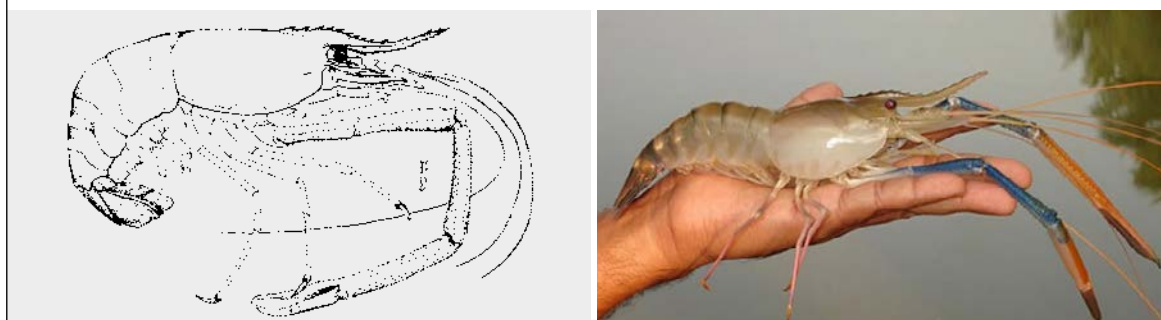

Description

The term prawn refers to a very diverse group of stalk-eyed freshwater decapod crustaceans with long narrow muscular abdomens, long antenna and slender legs (Figure 7.12). They can be found feeding on the bottom of most coastlines and

estuaries, as well as in freshwater systems. They usually live from one to seven years, and most species are omnivores. Shrimp and prawns, respectively, commonly refer to saltwater and freshwater species, although these names are often confused, especially in the culinary sense.

Prawns can be a great addition to an aquaponic system. They consume uneaten fish food, fish waste and whatever organic material they find in the water or on the bottom. As such, they help to clean and support system health, and accelerate organic material decomposition. It is better to grow prawns and mid-water fish simultaneously in an aquaponic system, as prawns cannot be grown in high enough densities to produce adequate wastes for the plants. Prawns are very territorial, so they need a substantial allocation of lateral space; the horizontal surface area determines the number of individuals that can be raised, although stacked layers of netting can increase surface area and increase quantity. Some polyculture systems with tilapia have been tested with various degree of success, although the number of individual that can be stocked is low. Most prawns have similar needs, which include hard water, warm temperatures (24–31 C°) and good water quality, but the conditions should be adjusted for the particular species grown.

In ideal conditions, prawns have a four-month growing cycle, meaning it is theoretically possible to grow three crops annually. Prawn post-larvae need to be purchased from a hatchery. The larval cycle of prawns is fairly complex, requiring carefully monitored water quality and special feed. Although possible on a small-scale, breeding prawns is only recommended for experts. Because they can eat the roots of the plants, prawns should be grown in the fish tanks only.

7.5 ACCLIMATIZING FISH

Acclimatizing fish into new tanks can be a highly stressful process for fish, particularly the actual transport from one location to another in bags or small tanks (Figure 7.13). It is important to try to remove as many stressful factors as possible that can cause fatality in new fish. There are two main factors that cause stress when acclimatizing fish: changes in temperature and pH between the original water and new water; these must be kept to a minimum.

The pH of the culture water and transport water should ideally be tested. If the pH values are more than 0.5 different, then the fish will need at least 24 hours to adjust. Keep the fish in a small aerated tank of their original water and slowly add water from the new tank over the course of a day. Even if the pH values of the two environments are fairly close, the fish still need to acclimatize. The best method to do this is to slowly allow the temperature to equilibrate by floating the sealed transportation bags containing the fish in the culture water. This should be done for at least 15 minutes. At this time small amounts of water should be added from the culture water to the



transport water with the fish. Again, this should take at least 15 minutes so as to slowly acclimatize the fish. Finally, the fish can be added to the new tank.

7.6 FISH HEALTH AND DISEASE

The most important way to maintain healthy fish in any aquaculture system is to monitor and observe them daily, noting their behaviour and physical appearance. Typically, this is done before, during and after feeding. Maintaining good water quality, including all of the parameters discussed above, makes the fish more resistant to parasites and disease by allowing the fishes' natural immune system to fight off infections. This section discusses briefly key aspects of fish health, including practical methods to identify unhealthy fish and prevent fish disease. These key aspects are:

- Observe fish behaviour and appearance on a daily basis, noting any changes.
- Understand the signs and symptoms of stress, disease and parasites.
- Maintain a low-stress environment, with good and consistent water quality, specific to the species.
- Use recommended stocking density and feeding rates.

7.6.1 Fish health and well-being

The main indicator of fish well-being is their behaviour. In order to maintain healthy fish, it is important to recognize the behaviour of healthy fish as well as the signs of stress, disease and parasites. The best time to observe fish is during their daily feeding, both before and after adding the feed, and noting how much feed is eaten. Healthy fish exhibit the following behaviour:

- Fins are extended, tails are straight.
- Swimming in normal, graceful patterns. No lethargy. However, catfish often sleep on the bottom until they wake up and begin feeding.
- Strong appetite and not shying away at the presence of the feeder.
- No marks along the body. No discoloured blotches, streaks or lines.
- No rubbing or scraping on the sides of the tank.
- No breathing air from the surface.
- Clear sharp shiny eyes.

7.6.2 Stress

Stress has been mentioned several times throughout this publication and deserves special attention here. Generally, stress is a physiological response of the fish when they live in less than optimal conditions. Overstocking, incorrect temperatures or pH, low DO and inappropriate feeding all cause stress (Table 7.2). The fishes' bodies have to work harder to overcome these poor conditions, resulting in a depressed immune system. With a depressed immune system, the ability of the fish to heal and ward

TABLE 7.2
Causes and symptoms of stress in fish

Causes of stress	Symptoms of stress
Temperature outside of range, or fast temperature changes	Poor appetite
pH outside of range, or fast pH changes (more than 0.3/day)	Unusual swimming behaviour, resting at surface or bottom
Ammonia, nitrite or toxins present in high levels	Rubbing or scraping the sides of the tank, piping at surface, red blotches and streaks
Dissolved oxygen is too low	Piping at surface
Malnourishment and/or overcrowding	Fins are clamped close to their body, physical injuries
Poor water quality	Fast breathing
Poor fish handling, noise or light disturbance	Erratic behaviour
Bullying companions	Physical injuries

off disease is reduced. Stress can actually be measured in fish by monitoring certain hormones. Stress is an overall state of being, and stress alone does not kill the fish. However, if fish are stressed for an extended period, they will inevitably develop diseases from various bacteria, fungi and/or parasites. Avoid stress wherever possible, and realize that multiple factors can contribute to stress at the same time.

7.6.3 Fish disease

Disease is always the result of an imbalance between the fish, the pathogen/causative agent and the environment. Weakness in the animal and a higher incidence of the pathogen in certain conditions cause disease. Sound fish management practices that build a healthy defence system are the primary actions to secure a healthy stock. Therefore, adequate environmental control is equally essential in order to avoid stress in fish and to reduce the incidence of pathogens.

Diseases are caused from both abiotic and biotic factors. In previous chapters, water quality parameters have already been indicated as determinant factors to avoid metabolic disorders and mortality. In addition, control of climatic conditions as well as contaminants can offset many opportunistic infections and toxicity. The contained characteristics of recirculating systems make aquaponics less prone to pathogen introductions and disease outbreaks because of better control of inputs and in the management of key water and environmental parameters. In the case of incoming water from water bodies, the simple adoption of slow sand filtration can protect the aquaponic system from any possible parasite or bacteria introduction. Similarly, the elimination of snails and small crustaceans, as well as preventing the access or the contamination from animals and birds, can help offset the problems of parasites as well as possible bacterial contamination.

The three major groups of pathogens that cause fish disease are fungus, bacteria and parasites. All of these pathogens can easily enter an aquaculture system from the environment, when adding new fish or new water, or could have previously existed in the unit. Prevention is by far the best way to prevent disease in fish. Daily observation of fish and monitoring for disease allows the disease, if present, to be treated quickly to prevent more fish from being infected (Figure 7.14). Treatment options for small-scale aquaponics are limited. Prevent disease as much as possible.

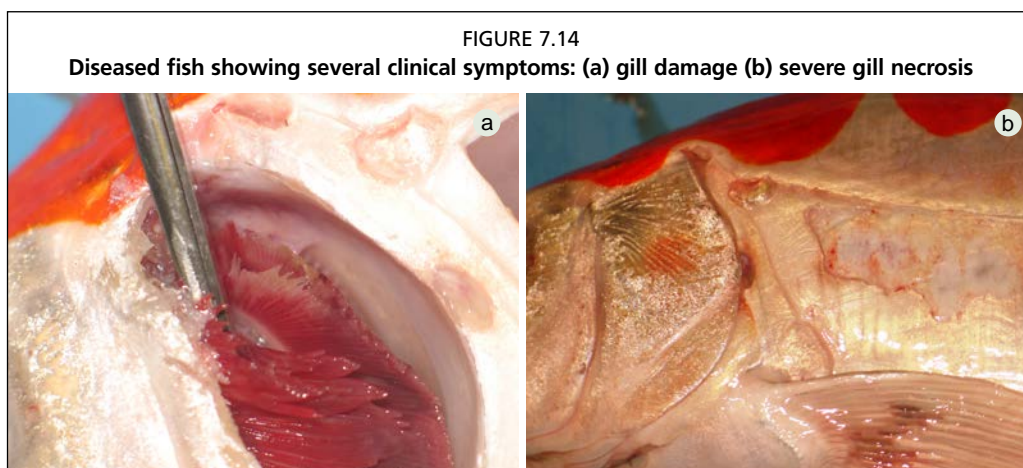

Preventing disease

The list below outlines some key actions for preventing disease and summarizes major lessons for growing fish in aquaponics:

- Obtain healthy fish seed from a reliable, reputable and professional hatchery.
- Never add unhealthy fish to the system. Examine new fish for signs of disease.
- It is advisable in some cases to quarantine new fish in an isolation tank for 45 days before adding them to the main system.

- If possible and necessary treat new fish with a salt bath (described below) to remove parasites or treat some early stage infections.
- Ensure that the water source is from a reliable origin and use some sterilization method if it comes from a well or water bodies. Remove chlorine from water if it is from a municipal source.
- Maintain key water quality parameters at optimum levels at all times.
- Avoid sharp changes in pH, ammonia, DO and temperature.
- Ensure adequate biological filtration to prevent ammonia or nitrite accumulation.
- Ensure adequate aeration to keep DO levels as high as possible.
- Feed the fish a balanced and nutritious diet.
- Keep the fish feed in a cool dry and dark place to prevent it from moulding.
- Make sure that live food sources are pathogen-free and parasite-free. Feed that is not from a verifiable origin should be pasteurized or sterilized.
- Remove uneaten feed and any source of organic pollution from the tank.
- Make sure the fish tank is shaded from direct sunlight, but not in complete darkness.
- Prevent access of birds, snails, amphibians and rodents that can be vectors of pathogens or parasites.
- Do not allow pets or any domestic animals to access the production area.
- Follow standard hygiene procedures by washing hands, cleaning/sterilizing gear.
- Do not allow visitors to touch the water or handle fish without following proper hygiene procedures.
- Use one fish net for each fish tank to prevent cross-contamination of diseases or parasites.
- Avoid loud noise, flickering lights or vibration near the fish tank.

Recognizing disease

Diseases may occur even with all of the prevention techniques listed above. It is important to stay vigilant and monitor and observe fish behaviour daily to recognize the diseases early. The following lists outline common physical and behavioural symptoms of diseases. For a more detailed list of symptoms and more specific remedies please refer to Appendix 3.

External signs of disease:

- ulcers on body surface, discoloured patches, white or black spots
- ragged fins, exposed fin rays
- gill and fin necrosis and decay
- abnormal body configuration, twisted spine, deformed jaws
- extended abdomen, swollen appearance
- cotton-like lesions on the body
- swollen, popped-out eyes (exophthalmia)

Behavioural signs of disease:

- poor appetite, changes in feeding habits
- lethargy, different swimming patterns, listlessness
- odd position in water, head or tail down, difficulty maintaining buoyancy
- fish gasping at the surface
- fish rubbing or scraping against objects

Abiotic diseases

Most of the mortalities in aquaponics are not caused by pathogens, but rather by abiotic causes mainly related to water quality or toxicity. Nevertheless, such agents can induce opportunistic infections that can easily occur in unhealthy or stressed fish. The

identification of these causes can also help the aquaponic farmer to distinguish between metabolic and pathogenic diseases and lead to prompt identification of the causes and remedies. Appendix 3 contains a list of the most common abiotic diseases and their symptoms.

Biotic diseases

In general, aquaponics and recirculating systems are less affected than pond or cage aquaculture farming by pathogens. In most cases, pathogens are actually already present in the system, but disease does not occur because the fishes' immune system is resisting infection and the environment is unfavourable for the pathogen to thrive. Healthy management, stress avoidance and quality control of water are thus necessary to minimize any disease incidence. Whenever disease occurs, it is important to isolate or eliminate the infected fish from the rest of the stock and implement strategies to prevent any transmission risk to the rest of the stock. If any cure is put into action, it is fundamental that the fish be treated in a quarantine tank, and that any products used are not introduced into the aquaponic system. This is in order to avoid any unpredictable consequences to the beneficial bacteria. Appendix 3 indicates some of the most common biotic diseases occurring in fish farming and the remedies normally adopted. More details are available from the literature and from local fishery extension services.

Treating disease

If a significant percentage of fish are showing signs of disease, it is likely that the environmental conditions are causing stress. In these cases, check levels of ammonia, nitrite, nitrate, pH and temperature, and respond accordingly. If only a few fish are affected, it is important to remove the infected fish immediately in order to prevent any spread of the disease to other fish. Once removed, inspect the fish carefully and attempt to determine the specific disease/cause. Use this publication as a starting guide and then refer to outside literature. However, it may be necessary to have a professional diagnosis carried out by a veterinarian, extension agent or other aquaculture expert. Knowing the specific disease helps to determine the treatment options. Place the affected fish in a separate tank, sometimes called a quarantine or hospital tank, for further observation. Kill and dispose of the fish, as appropriate.

Disease treatment options in small-scale aquaponics are limited. Commercial drugs can be expensive and/or difficult to procure. Moreover, antibacterial and antiparasite treatments have detrimental effects on the rest of the system, including the biofilter and plants. If treatment is absolutely necessary, it should be done in a hospital tank only; antibacterial chemicals should never be added to an aquaponic unit. One effective treatment options against some of the most common bacterial and parasite infections is a salt bath.

Salt bath treatment

Fish affected with some ectoparasites, moulds and bacterial gill contamination can benefit from salt bath treatment. Infected fish can be removed from the main fish tank and placed into a salt bath. This salt bath is toxic to the pathogens, but non-fatal to the fish. The salt concentration for the bath should be 1 kg of salt per 100 litres of water. Affected fish should be placed in this salty solution for 20–30 minutes, and then moved to a second isolation tank containing 1–2 g of salt per litre of water for another 5–7 days.

In bad white-spot infections, all fish may need to be removed from the main aquaponic system and treated this way for at least a week. During this time, any emerging parasites in the aquaponic unit will fail to find a host and eventually die. The heating of the water in the aquaponic system can also shorten the parasite life cycle

and make the salt treatment more effective. Do not use any of the salt bath water when moving the fish back into the aquaponic system because the salt concentrations would negatively affect the cultured plants.

7.7 PRODUCT QUALITY

In cultured fish, particularly freshwater species, there is often the risk of off-flavour. In general, this reduction in flesh quality is due to the presence of specific compounds, the most common of which are geosmin and 2-methylisoborneol. These secondary metabolites, which accumulate in the lipid tissue of fish, are produced by the blue-green algae (cyanobacteria) or by the bacteria of the genus *Streptomyces*, actinomycetes and myxobacteria. Geosmin gives a clear muddy flavour, while 2-methylisoborneol gives a mildewed taste that can severely affect consumer acceptance and disrupt the marketability of the product. Off-flavour occurs in both earthen ponds and RASs.

A common remedy for off-flavours consists of purging the fish for 3–5 days in clean water before sale or consumption. Fish must starve and be kept in a separated and aerated tank. In aquaponics, this process can be easily integrated in the ordinary management as the water used for the purging can be eventually used to refill the system.

7.8 CHAPTER SUMMARY

- Standard manufactured fish feed pellets are recommended for use in aquaponics because they are a whole feed containing the correct balance of proteins, carbohydrates, fats, vitamins and minerals needed for fish.
- Protein is the most important component for building fish body mass. Omnivorous fish such as tilapia and common carp need about 32 percent protein in their diet, carnivorous fish need more.
- Never overfeed the fish, and remove uneaten food after 30 minutes to reduce risks of ammonia or hydrogen sulphide toxicity.
- Water quality needs to be maintained for fish. Ammonia and nitrite must be close to 0 mg/litre as they are toxic at any detectable levels. Nitrate should be less than 400 mg/litre. DO should be 4–8 mg/litre.
- Tilapia, carp, and catfish are highly suitable for aquaponics in tropical or arid conditions as they grow quickly and can survive in poor quality water and at lower DO levels. Trout grow well in cold water, but require better water quality.
- Fish health should be monitored daily, and stress should be minimized. Poor and/or changing water quality, overcrowding, and physical disturbance can cause stress, which may lead to disease outbreaks.
- Abnormalities behaviour or changes in physical behaviour can indicate stress, bad water quality, parasites or disease. Take the time to observe and monitor the fish in order to recognize symptoms early and provide treatment.

8. Management and troubleshooting

The previous chapters focused on the importance of bacteria to ensure good growth of both plants and fish, on the key factors when building the different aquaponic units, and how to properly care for both fish and plants in a single aquaponic unit. This chapter summarizes the main principles and “rules of thumb” to provide a reference on the optimal fish-to-plant ratio, feeding regime and biofilter sizing.

The second section of this chapter lists all the important management phases from starting a unit to production management over an entire growing season. There is also an in-depth discussion regarding the management of fish and plants during the first three months of production. Finally, this chapter sets out practical daily, weekly and monthly checklists for managing a unit over a growing season, and what to do if problems arise.

8.1 COMPONENT CALCULATIONS AND RATIOS

Aquaponic systems need to be balanced. The fish (and thus, fish feed) need to supply adequate nutrients for the plants; the plants need to filter the water for the fish. The biofilter needs to be large enough to process all of the fish wastes, and enough water volume is needed to circulate this system. This balance can be tricky to achieve in a new system, but this section provides helpful calculations to estimate the sizes of each of the components.

8.1.1 Plant growing area, amount of fish feed and amount of fish

The most successful way to balance an aquaponic system is to use the feed rate ratio described in Section 2.1.4. This ratio is the most important calculation for aquaponics so that the fish and plants can thrive symbiotically within the aquaponic ecosystem.

The ratio estimates how much fish feed should be added each day to the system, and it is calculated based on the area available for plant growth. This ratio depends on the type of plant being grown; fruiting vegetables require about one-third more nutrients than leafy greens to support flowers and fruit development. The type of feed also influences the feed rate ratio, and all calculations provided here assume an industry standard fish feed with 32 percent protein.

Leafy green plants	Fruiting vegetables
40–50 g of fish feed per square metre per day	50–80 g of fish feed per square metre per day

The recommended first step in the calculation is to determine how many plants are desired. On average, plants can be grown at the planting density shown below (Figure 8.1). These figures are only averages, and many variables exist depending on plant type and harvest size, and therefore should only be used as guidelines.

Leafy green plants	Fruiting vegetables
20–25 plants per square metre	4–8 plants per square metre

Once the desired number of plants has been chosen, it is then possible to determine the amount of growing area needed and, consequently, the amount of fish feed that should be added to the system every day can be determined.



Once the amounts of growing area and fish feed have been calculated, it is possible to determine the biomass of the fish needed to eat this fish feed. Different-sized fish have different feed requirements and regimes, this means that many small fish eat as much as a few large fish. In terms of balancing an aquaponic unit, the actual number of fish is not as important as the total biomass of fish in the tank. On average, for the species discussed in Section 7.4, the fish will consume 1–2 percent of their body weight per day during the grow-out stage. This assumes that the fish are larger than 50 g because small fish eat more than large ones, as a percentage of body weight.

Fish feeding rate

1–2 % of total body weight per day

The example below demonstrates how to conduct this set of calculations, determining that, in order to produce 25 heads of lettuce per week, an aquaponic system should have 10–20 kg of fish, fed 200 grams of feed per day, and have a growing area of 4 m². The calculations are as follows:

Lettuce requires 4 weeks to grow once the seedlings are transplanted into the system, and 25 heads per week are harvested, therefore:

$$25 \text{ heads/week} \times 4 \text{ weeks} = 100 \text{ heads in system}$$

Each 25 heads of lettuce require 1 m² of growing space, therefore:

$$100 \text{ heads} \times \frac{1 \text{ m}^2}{25 \text{ heads}} = 4 \text{ m}^2$$

Each square metre of growing space requires 50 g of fish feed per day, therefore:

$$4 \text{ m}^2 \times \frac{50 \text{ grams feed/day}}{1 \text{ m}^2} = 200 \text{ grams feed/day}$$

The fish (biomass) in a system eats 1–2 percent of their body weight per day, therefore:

$$200 \text{ grams feed/day} \times \frac{100 \text{ grams fish}}{1-2 \text{ grams feed/day}} = 10-20 \text{ kg of fish biomass}$$

Although extremely helpful, this feed ratio is really only a guide, particularly for small-scale units. There are many variables involved with this ratio, including the size and type of fish, water temperature, protein content of the feed and nutrient demands of the plants, which may change significantly over a growing season. These changes may require the farmer to adjust the feeding rate.

Testing the water for nitrogen helps to determine if the system remains in balance. If nitrate levels are too low (less than 5 mg/litre), then slowly increase the feed rate per day without overfeeding the fish. If the nitrate levels are stable, then there may be deficiencies in other nutrients and supplementation may be required especially for calcium, potassium and iron. If nitrate levels are increasing, then occasional water exchanges will be necessary as nitrate rises above 150 mg/litre. Increasing nitrate levels suggest that the concentration of other essential nutrients is adequate.

8.1.2 Water volume

The water volume is most important to the aquaculture aspect of aquaponics. Different stocking densities affect fish growth and health, and are one of the most common root causes for fish stress. However, the total water volume does not affect the hydroponic component, except that with large volumes of water it takes more time for the water to accumulate a substantial nutrient concentration during the initial cycling. Thus, if a unit has a relatively large water volume, the only impact is that it would take longer to reach the optimal nutrient concentrations for plants. Large water volumes help to mitigate changes in water quality, but may mask problems for longer. The DWC method always has a higher total water volume than the NFT or media beds.

The recommended maximum stocking density is 20 kg of fish for 1 000 litres of water (fish tank). The small-scale units described in this publication have about 1 000 litres of water and should contain 10–20 kg of fish. Higher stocking densities require more sophisticated aeration techniques to keep the DO levels stable for fish, as well as a more complex filtration system to deal with the solid waste. New aquaponic farmers are strongly recommended not to exceed the stocking density of 20 kg per 1 000 litres. This is particularly the case where a constant electricity supply is not guaranteed, because a brief interruption can kill all of the fish within an hour at high stocking densities. This same stocking density applies for any size tank larger than 500 litres; simply use this ratio to calculate the maximum stocking density for the given volume of water. If the tank is smaller than 500 litres, reduce stocking density to one-half, or 1 kg per 100 litres, though it is not recommended to grow fish for consumption in a tank smaller than 500 litres. For reference, an average tilapia weighs 500 g at harvest size and 50 g at stocking size.

Fish stocking density
10–20 kg of fish per 1 000 litres of water

8.1.3 Filtration requirements – biofilter and mechanical separator

The amount of biofiltration necessary in aquaponics is determined by the amount of feed entering the system daily. The main consideration is the type of biofilter material and surface area of that medium. The larger the surface area, the larger the bacterial colony that can be hosted and the faster ammonia is converted into nitrate. Two ratios are provided, one for the volcanic gravel found in media beds, and one for the Bioballs® found in NFT and DWC units. This calculation should be considered a minimum, and excess biofiltration does not harm the system but rather makes the system more resilient against ammonia and nitrite spikes. Biofilters should be oversized if it is suspected that low temperatures could affect bacterial activity. Appendix 4 contains more information on sizing biofilters and calculating the volume required.

Biofilter material	Specific surface area (m ² /m ³)	Volume required (litres/g of feed)
Volcanic gravel	300	1
Bioballs®	600	0.5

The mechanical separator should be sized based on the volume of water. Generally, the mechanical separator should have a volume of 10–30 percent of the fish tank size. Mechanical filters are needed for both the NFT and DWC systems, as well as media bed systems with high stocking densities (> 20 kg/1 000 litres).

8.1.4 Summary of component calculations

- The feed rate ratio provides a way to balance the components of an aquaponic system, and to calculate planting area, fish feed, and fish biomass.

- Feed rate ratio for aquaponics:
 - 40–50 grams of daily feed per square metre (leafy greens);
 - 50–80 grams of daily feed per square metre (fruiting vegetables).
- Fish feeding rate: 1–2 percent of their body weight per day.
- Fish stocking density: 10–20 kg/1 000 litres.
- Biofiltration volume:
 - 1 litre per gram of daily feed (cinders in media beds)
 - ½ litre per gram of daily feed (Bioballs® in NFT and DWC)

Table 8.1 summarizes the key figures and ratios for designing small-scale media bed, NFT and DWC units. It is important to be aware that the figures are just guides as other external factors (e.g. climate conditions, access to a constant supply of electricity) may change the design on the ground. Please note the footnotes below the table explaining the figures and the applicability of each column per aquaponic method.

TABLE 8.1
Practical system design guide for small-scale aquaponic units

Fish tank volume (litre)	Max. fish biomass ¹ (kg)	Feed rate ² (g/day)	Pump flow rate (litre/h)	Filters volume ³ (litre)	Min. volume of biofilter media ⁴ (litre)		Plant growing area ⁵ (m ²)
					Volcanic tuff	Bioballs®	
200	5	50	800	20	50	25	1
500	10	100	1 200	20–50	100	50	2
1 000	20	200	2 000	100–200	200	100	4
1 500	30	300	2 500	200–300	300	150	6
2 000	40	400	3 200	300–400	400	200	8
3 000	60	600	4 500	400–500	600	300	12

Notes:

1. The recommended fish density is based on a maximum stocking density of 20 kg/1 000 litres. Higher densities are possible with further aeration and mechanical filtration, but this is not recommended for beginners.
2. The recommended feeding rate is 1 percent of body weight per day for fish of more than 100 g of body mass. The feeding rate ratio is: 40–50 g/m² for leafy greens; and 50–80 g/m² for fruiting vegetables.
3. The volumes for mechanical separator and biofilter should be 10–30 percent of total fish tank volume. In reality, the choice of containers depends on their size, cost and availability. Biofilters are only needed for NFT and DWC units; mechanical separators are applicable for NFT, DWC units and media bed units with a fish density of more than 20 kg/1 000 litres.
4. These figures assume the bacteria are in optimal conditions all the time. If not, for a certain period (winter), extra filtration media may need to be added as a buffer. Different values are provided for the two most common biofilter media based on their respective specific surface area.
5. Figures for plant growing space include only leafy greens. Fruiting vegetables would have a slightly lower area.

8.2 NEW AQUAPONIC SYSTEMS AND INITIAL MANAGEMENT

8.2.1 Building and preparing the unit

Detailed step-by-step building instructions are provided in Appendix 8. Once the unit is complete, it is time to prepare the system for routine function. Although aquaponic unit management does not require excessive time and effort, it is important to remember that a well-functioning system requires a minimum of 10–20 minutes of maintenance every day. Before stocking a new system with fish and planting the vegetables, it is crucial to ensure that all of the equipment is working properly. The most important aspects to check are the water pump, the air pump and water heaters (where applicable). It is essential to check that the NFT pipes and media beds are steady and balanced horizontally. Start running water in the system and make sure that there are no leaks or loose plumbing connections. If there are, tighten or fix them immediately. Section 9.3 provides further methods to secure the water levels and prevent catastrophic loss-of-water events. Once built, cycle the water for at least two days in order to let any chlorine dissipate. This process can be accelerated using heavy aeration. This is not necessary where the source water contains no chlorine, such as rainwater or filtered water.

Media bed unit preparation

The growing medium (volcanic gravel, expanded clay) should be well washed. Fill the beds with the medium and let the water run through it; the water should be clear. Remove any sedimentation (if present) by flushing out the beds with water. If using an electric timer to flood and drain the beds, it is important to synchronize the time it takes to fill the growing beds and the flow rate of the water entering the bed. If using a bell siphon, the water flow rate should be adjusted to ensure the auto siphon function. The water flow rate must be enough to activate the siphon, but not so strong that it prevents the suction from stopping.

NFT and DWC unit preparation

Make sure that the water flowing into each grow pipe or canal is flowing at the right rate (1–2 litres/min for NFT; 1–4 hours retention time for DWC). Higher flow rates have a negative impact on the plant roots, while lower flow rates do not supply adequate nutrients or oxygen.

8.2.2 System cycling and establishing the biofilter

Once the unit has passed the initial component checks and has been running for 2–3 days with no problems, it is time to cycle the unit. As discussed in Chapter 5, system cycling is the term that describes the initial process of building a bacterial colony in a new aquaponic unit. Normally, this is a 3–6 week process that involves introducing an ammonia source in the unit to feed the nitrifying bacteria and help them proliferate. The steps involved have been outlined in Chapter 5 and they should be followed for every new unit.

During the cycling process, it is vital to test ammonia, nitrite and nitrate levels every 3–5 days to make sure the ammonia concentrations do not become harmful for bacteria (> 4 mg/litre). If they do, a water change is necessary. The unit has completed the cycling process when nitrate levels begin to rise and ammonia and nitrite levels fall close to zero.

8.3 MANAGEMENT PRACTICES FOR PLANTS

Seedlings can be planted into the system as soon as nitrates are detected. Expect these first plants to grow slowly and exhibit some temporary deficiencies because the nutrient supply in the water is temporarily small. It is recommended to wait 3–4 weeks to allow the nutrients to accrue. In general, aquaponic systems show a slightly lower growth rate than soil or hydroponic production in the first six weeks. However, once a sufficient nutrient base has been built within the unit (1–3 months) the plant growth rates become 2–3 times faster than in soil.

8.3.1 Review of planting guidelines

Plant selection

It is best to start a new aquaponic system with fast-growing robust plants with a low nutrient demand. Some examples are leafy green vegetables, such as salads, or nitrogen-fixing plants, such as beans or peas. After 2–3 months, the system is ready for larger fruiting vegetables that demand a greater amount of nutrients.

Plant spacing

Seedlings can be planted using a slightly denser spacing than for most vegetables in soil because in aquaponics the plants do not compete for water and nutrients. Even so, the plants still need enough room to reach their mature size and to avoid reciprocal competition for light, which would depress their marketable quality or favour vegetative growth instead of fruits. In addition, consider shading effects of the full-grown plants, which allows for the contemporary cropping of shade-tolerant species next to taller plants.

Supplementing iron

Some new aquaponic units experience iron deficiencies in the first 2–3 months of growing as iron is important during the early stages of plant growth and is not abundant in fish feed. Thus, it may be necessary to initially add chelated iron (soluble iron in powder form) to the unit to meet the requirements for plants. The recommendation is to add 1–2 mg/litre for the first 3 months of starting a unit, and again when iron deficiencies are present. Chelated iron can be bought from agricultural suppliers in powder form. Iron can also be supplemented by using aquaponics-safe organic fertilizers such as compost or seaweed tea, as iron is abundant in both. Section 9.1.1 discusses aquaponics-safe organic fertilizers.

8.3.2 Establishing a plant nursery

Vegetables are the most important output for small-scale aquaponic production. It is essential that only strong healthy seedlings are planted. Moreover, the planting methods applied must avoid transplant shock as much as possible. Thus, the recommendation is to establish a simple plant nursery to ensure an adequate supply of healthy seedlings ready to be planted into the aquaponic units. It is always best to have an excess of plants ready to go into the system, and often waiting for seedlings is a source of production delay.

A simple nursery bed can be constructed using horizontal wood lengths lined with polyethylene liner, as shown in Figure 8.2. Water is pumped into the bed for about half an hour each day (controlled by a simple electric timer), allowing water and moisture to soak into the growing media. The water is then slowly drained down into a tank below. This cycle is repeated daily in order to prevent water logging of the seedlings. Too much moisture increases the threat of fungal infections.

Polystyrene propagation trays are placed into the nursery bed and are filled with soil, inert grow media such as rockwool, peat, coco fibre, vermiculite, perlite or a potting mix with a combination of the various types of growing medium. Simpler alternatives for propagation trays are also possible using recyclable materials such as empty egg boxes (Figure 8.3). Choose propagation trays that allow adequate distance between seedlings in order to favour good growth without competition for light. Box 4 lists seven steps for sowing seeds.



Direct seeding in media beds

It is possible to sow seeds straight into the media bed (Figure 8.4). If using a flood-and-drain mechanism (e.g. bell siphon) the seeds may be washed around. Therefore, the siphon should be removed while sowing seeds in the bed, and then replaced when the first leaves begin to appear.

8.3.3 Transplanting seedlings

Transplanting seedlings obtained from soil beds is not recommended; it should only be done if strictly necessary. In this case, all of the soil needs to be washed out from the root system very gently (Figure 8.5) because it may carry plant pathogens. This washing process is very stressful for seedlings and it is possible to lose 4–5 days of growth as the plant adjusts to new conditions. Thus, it is preferable to start seeds using inert media (rockwool, vermiculite or coco fibre) in propagation trays as explained above. In this way, the seedlings can be transplanted with minimal shock. Larger plants from pots can also be planted, although again the soil needs to be removed. Avoid transplanting in the middle of the day because plant roots are extremely sensitive to direct sun light and leaves can face water stress due to the new growing conditions. It is recommended to plant at dusk so the young seedlings have a night to acclimatize to their new environment before the morning sun.

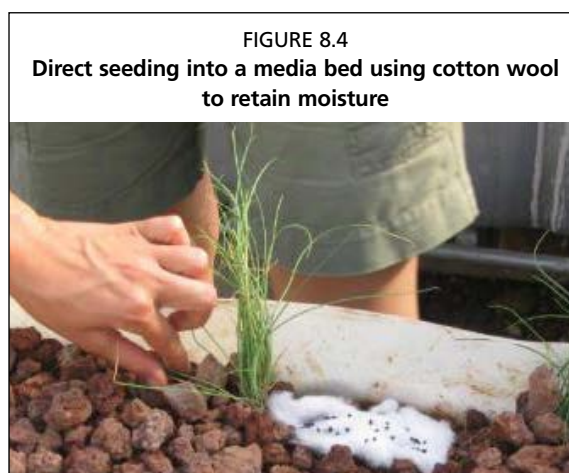
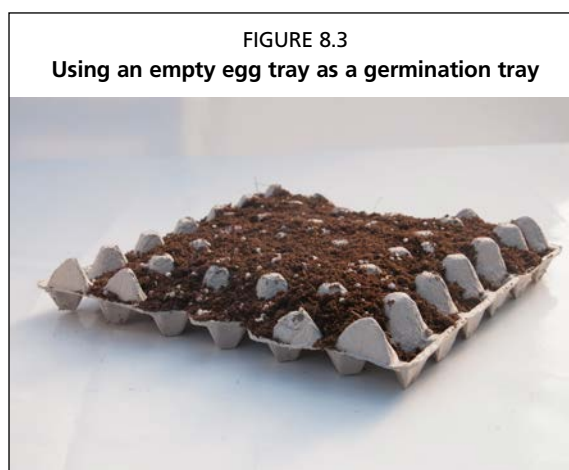

BOX 4

Seven steps to sow seeds using homemade propagation trays

- 1) Fill an empty egg tray or other seedling tray with growing media such as compost or coco fibre.
- 2) Sow the seeds in holes about 0.5 cm deep; cover the holes with the remaining media without compacting it.
- 3) Place the tray in a shaded area and irrigate. Automatic watering systems reduce labour.
- 4) After germination and sprouting and once the first leaves appear, begin to harden off the seedlings by placing them in increasingly intense sunlight for a few hours a day.
- 5) Fertilize the seedlings once a week with a gentle organic fertilizer high in phosphorous in order to strengthen their roots (optional).
- 6) Keep growing the seedlings for at least two weeks after first leaf appearance to ensure adequate root growth.
- 7) Transplant the seedlings into the system when adequate growth is achieved and plants are sufficiently strong. Release the seedlings and their soil plugs using a small blunt instrument.

FIGURE 8.5
Lettuce seedling with soil removed from roots
prior to transfer into an aquaponic unit



Media bed planting

When planting in volcanic gravel or any other growing media recommended in Chapter 6, simply push aside the gravel and dig a hole that is big enough to contain the plant (Figure 8.6). Plant at the highest point of flooding in the media bed (about 5–7 cm below the surface of the gravel) so the roots are partially submerged in water. Do not plant too deeply, which would allow water to contact the stem or leaves and could lead to disease (collar rot).

FIGURE 8.6
Step-by-step procedure of transferring a seedling into a media bed unit. Removing the seedling from the nursery tray (a); digging a small hole in the medium (b); planting the seedling (c); and backfilling with medium (d)



NFT planting

To plant in the grow pipes, the seedling needs to be supported with a short pipe or net cup containing 3–4 cm of gravel or other growing media (Figure 8.7). The rest of the net cup should be filled with a mixture of gravel and a moisture-retaining medium such as compost or coco fibre. The medium helps retain moisture because the young plant roots only barely touch the water flow inside the grow pipe. If coco fibre or compost is unavailable, then any standard medium will suffice. After one week, the roots should have extended out through the net up and into the grow pipe with full access to water flowing along the bottom of the pipe. In addition, wicks can be extended from the bottom of the net cup into the stream of water, if necessary.

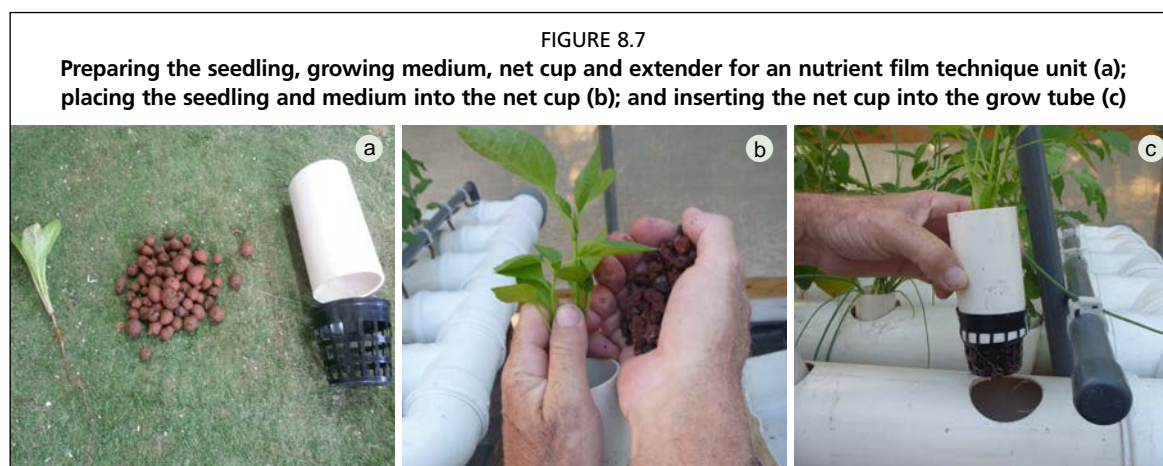

DWC planting

Similar to planting in NFT systems, DWC systems need the plant to be supported using a small net cup filled with 3–4 cm of inert medium (Figure 8.8). When the seedling is adequately supported, place it into one of the holes made in the polystyrene sheets to float on top of the water. The bottom of the net cup should just touch the water level.

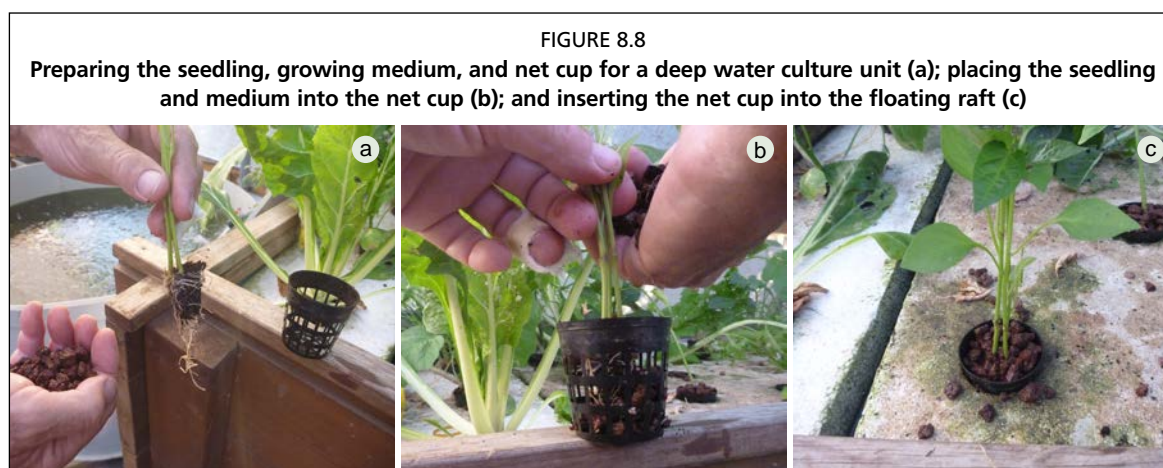

8.3.4 Harvesting plants

In 1–2 months, leafy green vegetables should be ready to harvest. After three months, the unit should also have enough of a nutrient base to begin planting larger fruiting vegetables. The following points below detail the final guidelines for growing plants after the initial three-month period.

Staggered planting and harvesting

As discussed in Chapter 6, it is worth staggering the planting over time in order to prevent harvesting the entire crop all at once. If this were to happen, nutrient levels would decrease just before harvest, which might create nutritional problems for the plants, and spike after the harvest, which would stress the fish. Moreover, staggered planting allows for continual harvest and transplant of vegetables and ensures constant nutrient uptake and water filtration.

Harvesting approaches

When harvesting full plants from media beds (i.e. lettuce), make sure the entire root system is removed. In addition, shake the gravel stuck in between the roots and place



the gravel back in the media bed. In NFT and DWC pipes/canals also make sure the whole root system is removed (Figure 8.9). Place the discarded plant roots into a compost bin to recycle the plant waste. Leaving roots and leaves in the system can encourage disease. When harvesting vegetables use a sharp clean knife. To prevent any bacteria contamination, ensure that aquaponic water does not wet the leaves. Place harvested plants into a clean bag and wash and chill the crops as soon as possible to maintain freshness.

8.3.5 Managing plants in mature systems

Stabilizing pH

It is vital for good plant growth to maintain the pH between 6 and 7, so plants have access to all the nutrients available in the water. Add small amounts of base or buffer whenever the pH approaches 6.0 in order to maintain optimum pH levels as described in Section 3.6. Add rainwater or correct with acid any alkalinity-rich water only if the hardness level in the aquaponic system is too high to prevent nitrifying bacteria from naturally lowering the pH to optimal levels. Treat the water with acid outside the aquaponic system, and pour the water into the system after checking the pH.

Organic fertilizers

If deficiencies do occur, it is necessary to add outside nutrients. Organic liquid fertilizer can be used as either diluted foliar feed for plant leaves or poured straight into the root zone. Chapter 9 discusses methods to produce simple home-made fertilizers that are aquaponic-safe. Compost tea and seaweed tea are recommended. Deficiencies are discussed in Section 6.2.3. Deficiencies often occur when there are too many plants for the number of fish, or when feeding is reduced during winter months. Before adding fertilizers, be sure to check pH to make sure there is no nutrient lockout.

Pests and disease

Be sure to try to prevent pests using the IPPM techniques discussed in Section 6.5. If pests remain a problem, begin by using the mechanical removal techniques before considering sprays. Only use aquaponic-safe remedies, such as: plant extracts or repellents, biological insecticides (*Bacillus thuringiensis* and *Beauveria bassiana*), soft soaps, ash, plant oils or extracts of essential oils, chromatic/attractant traps, and external attractant plants treated with insecticides. Regardless, avoid letting the spray enter the water.

Follow seasonal planting advice

To an extent, aquaponic food production methods provide a means to extend planting seasons, particularly if the unit is housed inside a greenhouse. However, it is still strongly recommended to follow local seasonal planting advice. Plants grow better in the season and environmental conditions to which they are adapted.

8.3.6 Plants – summary

- Use plants with low nutrient demands for the first few months, i.e. lettuce and beans/peas.
- Plants with high nutrient demands can be planted after the first 3–6 months.

- Use plants recommended for aquaponics, and follow seasonal planting guides for the location.
- Establish a plant nursery to ensure adequate numbers of healthy seedlings.
- Transplant adequately grown and strong seedlings that have a well-developed root system.
- Gently remove excess substrate from the roots before planting into the system.
- Leave sufficient spacing in between plants according to their size when mature.
- Plan a staggered harvesting system.
- Organic fertilizers may be necessary if deficiencies occur.
- Maintain appropriate water quality, especially a pH of 6–7.

8.4 MANAGEMENT PRACTICES FOR FISH

Adding fish to a new aquaponic unit is an important event. It is best to wait until the initial cycling process is totally completed and the biofilter is fully functioning. Ideally, the ammonia and nitrite are at zero and nitrates are beginning to rise. This is the safest time to add fish. If it is decided to add fish before cycling, then a reduced number of fish should be added. This time will be very stressful for the fish, and water changes may be necessary. Cycling the system with fish can actually take longer than fish-less cycling.

The fish must be properly acclimatized to the new water. Be sure to match the temperature and pH, and always acclimatize the fish slowly (as described in Section 7.5). When purchasing fingerlings from a local hatchery, make sure the fish are healthy and check carefully for any signs of disease.

8.4.1 Fish feeding and growth rates

The method of calculating the fish feed using the feed rate ratio applies to mature systems during the grow-out stage of the fish and needs further consideration here. Using the same example from Section 8.1.1, the target biomass for a 1 000 litre tank is 10–20 kg. This would be about 40 harvest-size tilapia. However, during the first 2–3 months, the fish are small and do not eat as much as was calculated (200 g of feed per day) to supply nutrients for the whole grow bed. More specifically, newly stocked fingerling-sized fish weigh about 50 grams. Juvenile fish can be fed about 3 percent of their body weight per day. Therefore, an initial stocking of 40 fingerlings would weigh 2 000 g, and together they would eat approximately 60 g of fish feed per day.

A low initial stocking density is a good practice for immature aquaponic systems because it gives the biofilter additional time to develop and allows the plants time to grow and filter more nitrate. The recommendation is to estimate feeding based on body weight, but to carefully monitor feeding behaviour and adjust the ration accordingly. As the fish grow, they begin to eat more food. Moreover, it is recommended to provide a diet comparatively richer in protein to juvenile fish, if different feeds formulations are available and feasible.

After 2–3 months feeding at this rate, the 40 fish will have grown to 80–100 grams each and weigh a total of 3 200–4 000 g. At this point, they should be able to eat 80–100 g of feed per day, which is still only half of that calculated by the feed rate ratio in the earlier example. Continue to feed the fish as much as they will eat, but increase the ration slowly to prevent wasted food. Within a few more months, these same fish will each weigh 500 g with a total biomass of 20 000 grams and eat 200 g of fish feed per day. For tilapia grown in good water quality at 25 °C, it takes 6–8 months to grow from as stocking size of 50 g to a harvest size of 500 g.

Make sure to divide the feeding into morning and afternoon rations. Moreover, juvenile fish benefit from an additional lunch-time feeding. Splitting the ration is healthier for the fish and also healthier for the plants, providing an even distribution of nutrients throughout the day. Spread the feed across the entire surface of the water so

all the fish can eat without injuring one another or hitting the side of the tank. Avoid scaring the fish during feeding by refraining from sudden movements. Stand still and observe the fish. Always remove any uneaten fish food after 30 minutes, and adjust the next feeding ration accordingly. If there is no food left after 30 minutes, increase the ration; if there is a lot left, decrease the ration.

A major indicator of healthy fish is a good appetite, so it is important to observe their general feeding behaviour. If their appetite declines, or if they stop feeding altogether, this is a major sign that something is wrong with the unit (most probably poor water quality). Moreover, fish appetite is directly related to water temperature, particularly for tropical fish such as tilapia, so remember to adjust or even stop feeding during colder winter months.

8.4.2 Harvesting and staggered stocking

A constant biomass of fish in the tanks ensures a constant supply of nutrients to the plants. This ensures that the fish eat the amount of feed calculated using the feed rate ratio. The previous example shows how the feeding ration depends on the size of the fish, and small fish are not be able to eat enough feed to supply the full growing area with adequate nutrients. To achieve a constant biomass in the fish tanks, a staggered stocking method should be adopted. This technique involves maintaining three age classes, or cohorts, within the same tank. Approximately every three months, the mature fish (500 g each) are harvested and immediately restocked with new fingerlings (50 g each). This method avoids harvesting all the fish at once, and instead retains a more consistent biomass.

Table 8.2 outlines the potential growth rates of tilapia in one tank over a year using the staggered stocking method. The important aspect of this table is that the total weight of the fish varies between 10–25 kg, with an average biomass of 17 kg. This table is a basic guideline depicting optimum conditions for fish growth. In reality factors such as water temperature and stressful environments for fish will distort the figures presented here.

TABLE 8.2

Potential growth rates of tilapia in one tank over a year using the staggered stocking method

Month	Dec.	Jan.	Feb.	Mar.	Apr.	May	Jun.	Jul.	Aug.	Sep.	Oct.	Nov.	Dec.
Stocking round	Weight (kg)												
1	1.5	3.75	6.0	8.25	10.5	12.75	15.0*						
2				1.5	3.75	6.0	8.25	10.5	12.75	15.0*			
3							1.5	3.75	6.0	8.25	10.5	12.75	15.0*
4										1.5	3.75	6	8.25
5													1.5
Total fish mass (kg)	1.50	3.75	6.0	9.75	14.25	18.75	24.75–9.75	14.25	18.75	24.75–9.75	14.25	18.75	24.75–9.75
Action							Restock harvest			Restock harvest			Restock harvest

Notes:

Fingerling tilapia (1.5 kg = 50 g/fish × 30 fish) are stocked every three months. Each fish survives and grows to harvest size (15 kg = 500 g/fish × 30 fish) in six months. The asterisk indicates harvest. The range during harvest/stocking months accounts for the range if not all 30 fish are taken at once, i.e. the 30 mature fish are harvested throughout the month. This table serves only as a theoretical guide to illustrate staggered harvest and stocking in ideal conditions.

If it is not possible to obtain fingerlings regularly, an aquaponic system can be still managed by stocking a higher number of juvenile fish and by progressively harvesting them during the season to maintain a stable biomass to fertilize the plants. Table 8.3 shows the case of a system stocked every six months with tilapia fingerlings of 50 g. In this case, the first harvest starts from the third month onward. Various combinations

TABLE 8.3
Potential growth rates of tilapia in one tank over a year using a progressive harvest technique

Month	Dec.	Jan.	Feb.	Mar.	Apr.	May	Jun.	Jul.	Aug.	Sep.	Oct.	Nov.	Dec.
Stocking round 1													
Number of fish in tank	80	80	70	60	50	40	30	10					
Fish weight (g)	50	125	200	275	350	425	500	575					
Cohort biomass (kg)	4	10	14	17	18	17	15	5.8					
Stocking round 2													
Number of fish in tank							80	80	70	60	50	40	30
Fish weight (g)							50	125	200	275	350	425	500
Cohort biomass (kg)							4	10	14	17	18	17	15
Total tank biomass (kg)	4	10	14	17	18	17	19	15.8	14	17	18	17	15

Notes:

Tilapia fingerling are stocked every six months. Staggered harvest starts from the third month to keep the total fish below the maximum stocking biomass of 20 kg/m³. The table shows the theoretical weight of each batch of harvested fish along the year if fish are reared in ideal conditions.

in stocking frequency, fish number and weight can apply, providing that fish biomass stands below the maximum limit of 20 kg/m³. If the fish are mixed-sex, the harvest must firstly target the females to avoid breeding when they reach sexual maturity from the age of five months. Breeding depresses the whole cohort. In the case of mixed-sex tilapia, fish can be initially stocked in a cage and males can then be left free in the tank after sex determination.

Remember that adult tilapia, catfish and trout will predate their smaller siblings if they are stocked together. A technique to keep all of these fish safely in the same fish tank is to isolate the smaller ones in a floating frame. This frame is essentially a floating cage, which can be constructed as a cube with PVC pipe used as frame and covered with plastic mesh. It is important to ensure that larger fish cannot enter the floating cage over the top, so make sure that the sides extend at least 15 cm above the water level. Each of the vulnerable size classes should be kept in separate floating frames in the main fish tank. As the fish grow large enough not to be in danger, they can be moved into the main tank. With this method, it is possible to have up to three different stocking weights in one tank, so it is important that the fish feed pellet size can be eaten by all sizes of fish. Caged fish also have the advantage of being closely monitored to determine the FCR by measuring the weight increment and weight of the feed over a period.

8.4.3 Fish – summary

- Add fish only after the fish-less cycling process is complete, if applicable.
- Feed the fish as much as they eat in 30 minutes, two times per day. Always remove uneaten feed after 30 minutes. Record total feed added. Balance the feeding rate with the number of plants using the feed rate ratio, but avoid over- or under-feeding the fish.
- Fish appetite is directly related to water temperature, particularly for tropical fish such as tilapia, so remember to adjust feeding during colder winter months.
- A fingerling tilapia (50 g) will reach harvest size (500 g) in 6–8 weeks under ideal conditions. Staggered stocking is a technique which involves stocking a system with new fingerlings each time some of the mature fish are harvested. It provides a way of maintaining relatively constant biomass, feeding rate and nutrient concentration for the plants.

8.5 ROUTINE MANAGEMENT PRACTICES

Below are daily, weekly and monthly activities to perform to ensure that the aquaponic unit is running well. These lists should be made into checklists and recorded. That way, multiple operators always know exactly what to do, and checklists prevent carelessness

that can occur with routine activities. These lists are not meant to be exhaustive, but merely a guideline based on the systems described here in this publication and as a review of the management activities.

8.5.1 Daily activities

- Check that the water and air pumps are working well, and clean their inlets from obstructions.
- Check that water is flowing.
- Check the water level, and add additional water to compensate for evaporation, as necessary.
- Check for leaks.
- Check water temperature.
- Feed the fish (2–3 times a day if possible), remove uneaten feed and adjust feeding rates.
- At each feeding, check the behaviour and appearance of the fish.
- Check the plants for pests. Manage pests, as necessary.
- Remove any dead fish. Remove any sick plants/branches.
- Remove solids from the clarifier and rinse any filters.

8.5.2 Weekly activities

- Perform water quality tests for pH, ammonia, nitrite and nitrate before feeding the fish.
- Adjust the pH, as necessary.
- Check the plants looking for deficiencies. Add organic fertilizer, as necessary.
- Clear fish waste from the bottom of fish tanks and in the biofilter.
- Plant and harvest the vegetables, as required.
- Harvest fish, if required.
- Check that plant roots are not obstructing any pipes or water flow.

8.5.3 Monthly activities

- Stock new fish in the tanks, if required.
- Clean out the biofilter, clarifier and all the filters.
- Clean the bottom of the fish tank using fish nets.
- Weigh a sample of fish and check thoroughly for any disease.

8.6 SAFETY AT WORK

Safety is important for both the human operator and the system itself. The most dangerous aspect of aquaponics is the proximity of electricity and water, so proper precautions should be taken. Food safety is important to ensure that no pathogens are transferred to human food. Finally, it is important to take precautions against introducing pathogens to the system from humans.

8.6.1 Electrical safety

Always use a residual-current device (RCD). This is a type of circuit breaker that will cut the power to the system if electricity grounds into the water. The best option is to have an electrician install one at the main electric junction. Alternatively, RCD adaptors are available, and inexpensive, at any hardware or home improvement store. An example of an RCD can be found on most hairdryers. This simple precaution can save lives. Moreover, never hang wires over the fish tanks or filters. Protect cables, sockets and plugs from the elements, especially rain, splashing water and humidity. There are outdoor junction boxes available for these purposes. Check often for exposed wires, frayed cables or faulty equipment, and replace accordingly. Utilize “drip loops” where appropriate to prevent water from running down a wire into the junction.

8.6.2 Food safety

Good agricultural practices (GAPs), should be adopted to reduce as far as possible any food-borne illnesses, and several apply to aquaponics. The first and most important is simple: always be clean. Most diseases that affect humans would be introduced into the system by the workers themselves. Use proper hand-washing techniques and always sanitize harvesting equipment. When harvesting, do not let the water touch the produce; do not let wet hands or wet gloves touch the produce either. If present, most pathogens are in the water and not on the produce. Always wash produce after harvesting, and again before consumption.

Second, keep soil and faeces from entering the system. Do not place harvesting equipment on the ground. Prevent vermin, such as rats, from entering the system, and keep pets and livestock away from the area. Warm-blooded animals often carry diseases that can be transferred to humans. Prevent birds from contaminating the system however possible, including through the use of exclusion netting and deterrents. If using rainwater collection, ensure that birds are not roosting on the collection area, or consider treating the water before adding it to the system. Preferably do not handle the fish, plants or media with bare hands, instead use disposable gloves.

8.6.3 General safety

Often aquaponic units, and farms and gardens in general, have other general hazards that can be avoided with simple precautions. Avoid leaving power cords, air lines or pipes in walkways, as they can pose a trip hazard. Water and media are heavy, so use proper lifting techniques. Wear protective gloves when working with the fish and avoid the spines. Treat any scrapes and punctures immediately with standard first-aid procedures – washing, disinfecting and bandaging the wound. Seek medical attention, if necessary. Do not let blood or body fluids enter the system, and do not work with open wounds. When constructing the system, be aware of saws, drills and other tools. Keep acids and bases in safe storage areas, and use proper safety gear when handling these chemicals. Always keep all dangerous chemicals and objects properly stored and away from children.

8.6.4 Safety – summary

- Use RCD on electric components to avoid electrocution.
- Shelter any electric connections from rain, splashes and humidity using correct equipment.
- Adopt GAPs to prevent contamination of produce. Always keep harvesting tools clean, wash hands often and wear gloves. Do not let animal faeces contaminate the system.
- Do not contaminate the system by using bare hands in the water.
- Avoid trip hazards by keeping a neat workstation.
- Wear gloves when handling fish and avoid spines.
- Wash and disinfect wounds immediately. Do not work with open wounds. Do not let blood enter the system.
- Be careful with power tools and dangerous chemicals, and wear protective gear.

8.7 TROUBLESHOOTING

Table 8.4 lists the most common problems when running an aquaponic unit. If anything appears out of the ordinary, immediately check that the water pump and air pumps are functioning. Low DO levels, including accidental leaks, are the number one killer in aquaponic units. As long as the water is flowing, the system is not in an emergency phase and the problem can be addressed systematically and calmly. The first step is always to conduct a full water quality analysis. Understanding the water quality provides feedback essential for determining how to solve any problem.

TABLE 8.4
Troubleshooting for common problems in aquaponic systems

Situation	Reason	Problem	Solution
1) Electricity/pump and system problems			
Pump not working; electricity is off.	No electric power.	DO will decrease.	<ol style="list-style-type: none"> 1) If electricity supply is unreliable, a DC backup power system should be installed. 2) Take water from the sump tank and pour into the fish tank, temporarily replenishing oxygen levels; repeat this process every 1–2 hours until power returns. 3) Install a 200 litre container above the fish tank that can release a slow stream of water into the fish tank, creating bubbles.
Pump not working; electricity is on.	Pump is either broken, faulty or clogged.	DO will decrease.	Check and clear any obstructions on pre-filter or in pipes. Replace pump immediately, if faulty.
Pool of water underneath system or water unusually low.	Leaks or cracks.	All water will drain out, stressing and eventually killing the fish and plants.	Fix any leaks or holes immediately. Use standpipe to prevent fish tank from losing water. Replenish water.
Water in system and sides of fish tank looks green.	Algal bloom.	DO will decrease.	Shade the system, and physically remove mature blooms of algae.
2) Water quality problems			
Ammonia or nitrite > 1 mg/litre.	<ol style="list-style-type: none"> 1) The bacteria are not functioning. 2) Too many fish for the size of the biofilter. 3) Accumulated non-living biomass: uneaten food, dead fish, solid wastes. 	Fish will be stressed and die.	<ol style="list-style-type: none"> 1) Immediately change 1/3–1/2 of system water with new water. 2) Remove all uneaten food, dead fish or build-up of solid waste in the tank. 3) Stop feeding until levels decrease. 4) Make sure pH and temperature are optimum for bacteria. 5) If nitrite is high, add 1 g of salt for every litre to immediately neutralize the toxic water quality threat. Afterwards, change the entire water volume over a period of 2 weeks. 6) Recalculate component ratios, biofilter size and feeding regime.
Nitrate levels > 120 mg/litre for a number of weeks.	High feed rate ratio.	No immediate problems, but toxicities may occur if nitrate keeps increasing.	Exchange water and use dumped water to irrigate crops.
Carbonate hardness (KH) is 0 mg/litre.	All of the carbonate is used by the acid created in the aquaponic unit.	The pH of the water will change quickly, stressing the fish and plants.	Add calcium carbonate (limestone gravel or shells) to the unit.
3) Fish problems			
Fish are piping at water surface.	Oxygen levels are too low.	Fish will be highly stressed and die.	<ol style="list-style-type: none"> 1) Make sure electricity is on and pump is fully working. 2) Make sure the bell siphon and air pumps are functional. 3) Make sure system tanks are fully covered to reduce temperature. 4) Add supplemental aeration.
Fish are not eating	<ol style="list-style-type: none"> 1) DO is low. 2) Ammonia and/or nitrite are too high. 3) pH is too high or too low. 4) Fish have diseases. 	Fish are stressed and will develop disease or die.	<ol style="list-style-type: none"> 1) Perform water quality tests for ammonia, pH, nitrite and nitrate. 2) Identify why fish are stressed (pH increase, ammonia or nitrite increase, oxygen decrease, organic pollution, disease) and fix the problem.

TABLE 8.4 (CONTINUED)

Situation	Reason	Problem	Solution
Water temperature is too high (>33 °C) or too low (<15 °C).	Climate.	If temperature is too high: fish will stop eating and plants will begin to wilt and die. If temperature is too low: bacteria will stop working, some fish may not eat.	1) In summer, make sure system tanks are shaded so the water stays relatively cool. 2) In winter, first isolate and then insulate the fish tanks. Then, use solar or electric heaters, and reduce the amount of fish food and vegetables growing in the unit. 3) Change fish species with ones more appropriate for that climate.
4) Plant problems			
Plants are not growing and/or leaves are changing colour.	Plants are deficient in some essential nutrients (or temperature is too high for certain plants, plants are diseased).	Plants will not grow or produce fruit.	1) Make sure water quality is optimum for plants. 2) Check nitrate levels: if they are too low, slowly increase fish feed per day. 3) Check if there is any root/stem disease. 4) Add aquaponic-safe fertilizer to plants.
Nitrate levels are high yet plants leaves are yellowing	1) pH is not at optimal level (too high or low). 2) Plants are deficient in some essential nutrients.	Plants will not grow fully or produce fruit.	1) Check if the yellowing is on new or old leaves. If on new, add iron up to 3 mg/litre. 2) Check pH and adjust if it is not optimum. 3) Add aquaponic-safe fertilizer such as compost or seaweed tea to plants.
Vegetables surrounding the water entry pipe are thriving while other vegetables farther away are struggling.	Vegetables around the entry pipe are taking up all the nutrients.	Uneven growth of vegetables in media beds.	1) Spread the water all around the grow beds using irrigation pipe with small holes. 2) Remove the media bed standpipe every day to flush the water in the media bed out into the sump tank. 3) Check nitrate levels; if too low, slowly increase fish feed given per day.

8.8 CHAPTER SUMMARY

The ten most important aspects of aquaponic unit management are:

- Observe and monitor the system every day.
- Ensure adequate aeration and water circulation with water pumps and air pumps.
- Maintain good water quality: pH 6–7; DO > 5 mg/litre; TAN < 1 mg/litre; NO₂⁻ < 1 mg/litre; NO₃⁻ 5–150 mg/litre; temperature 18–30 °C.
- Choose fish and plants according to seasonal climate.
- Do not overcrowd the fish tanks (< 20 kg/1 000 litres).
- Avoid overfeeding, and remove any uneaten food after 30 minutes.
- Remove solid wastes, and keep tanks clean and shaded.
- Balance the number of plants, fish and size of biofilter.
- Stagger harvesting and restocking/replanting to maintain balance.
- Do not let pathogens enter the system from people or animals, and do not contaminate produce with system water by letting system water wet the leaves.

9. Additional topics on aquaponics

This final chapter discusses minor, yet important, topics regarding the management of small-scale aquaponic units. Aquaponics requires several essential inputs, including fish feed, electricity, seeds/seedlings, fish fingerlings, supplemental plant fertilizer and water to replenish the unit. All of these inputs are available for purchase, yet there are simple methods of producing many of them domestically using sustainable practices. These methods may reduce the unit running costs per year and help keep production as environmentally responsible as possible.

Do not allow all of the water to drain from the aquaponic system. Broken pipes, loose fittings or unsecured hoses can drain all of the water. This would kill the fish and make a destructive mess in the process. Several techniques for fail-safes and redundancies are discussed to secure the water level. Finally, there is a brief discussion as to how aquaponics fits among other types of agriculture and how it can be further integrated.

9.1 SUSTAINABLE, LOCAL ALTERNATIVES FOR AQUAPONIC INPUTS

9.1.1 Organic plant fertilizers

Chapter 6 discussed how even balanced aquaponic systems can experience nutrient deficiencies. Although fish food pellets are a whole feed for fish, they do not necessarily have the right quantities of nutrients for plants. Generally, fish feeds have low iron, calcium and potassium values. Plant deficiencies can also arise in suboptimal growing conditions, such as cold weather and winter months. Thus, supplementary plant fertilizers may be necessary, particularly when growing fruiting vegetables or those with high nutrient demands. Synthetic fertilizers are often too harsh for aquaponics and can upset the balanced ecosystem; instead, aquaponics can rely on compost tea for any nutrient supplementation.

General composting process

Compost is a rich fertilizer that is made from broken down organic matter, including food waste. Compost is extremely useful in soil-based gardening for replenishing organic material, retaining moisture and providing nutrients. In addition, compost can be used to create a liquid fertilizer, called compost tea, which can be added to the aquaponic water to boost the supply of nutrients. Conveniently, high-quality compost can be made from household food waste. Basically, food waste is added to a container, hereafter called the compost unit. Within the compost unit, aerobic bacteria, fungi and other organisms break the organic matter down into simple nutrients for plants to consume. The final substance that is produced is called humus. It consists of about 65 percent organic matter, is free of pathogens and is full of nutrients. The whole process from food waste to humus can take up to six months depending on the temperature inside the compost unit and quality of aeration.

A compost unit is generally a 200–300 litre, barrel-shaped container with a lid and many vents (Figure 9.1). They are usually dark coloured to retain heat, which accelerates the decomposition process. Many types of compost units are available, and they are very easy to build with recycled parts. Compost units that tumble are recommended because they require less space and remain well-aerated and homogenous. Be sure to have enough space to spin the barrel properly. All compost units require adequate airflow.

FIGURE 9.1
Upright compost unit



When making compost, it is important to manage the materials that are going into it. It is best to keep a good ratio of wet and dry organic material layered in equal amounts to reach a moisture content of about 60–70 percent. As the initial 2–3 weeks are a thermal aerobic process with temperatures up to 60–70 °C, it is important to avoid excessive moisture that would reduce the heat. The thermal stage accelerates the composting process and helps to pasteurize the organic wastes from any possible pathogens. The layering is important in order to keep the compost from being too wet and to prevent anaerobic zones. The frequent aeration of the pile is an important task in order to keep bacteria in aerobic conditions and to process the wastes uniformly. The operation consists of simply turning the waste upside down or periodically rotating the drum/container. This helps to aerate the aerobic bacteria.

Good green compost can be obtained from a blend of wet materials, such as vegetable food leftovers, ground coffee, fruits and vegetables, and dry materials such as bread, grass clippings, dry leaves, straw, ash, and wood chips. However, it is important to keep an optimal balance between carbon and nitrogen (C:N ratio at 20–30) as it results in a rapid transformation of the material. In general, it is wise not to use too much straw or wood chips (C:N > 100) but rather use “green” wastes such as grass clippings, preferably slightly dried to reduce their moisture content. It is not recommended to use too much wood ash to avoid excessive pH increases, and to use only ash from wood/vegetable origin, as other sources (i.e. paper) may contain toxic substances. Some material should never be composted, including dairy, meat, citrus fruit, plastic, glass, metal and nylon. Compost is very forgiving, but ideally the compost should have enough moisture and nitrogen to feed all of the beneficial organisms. Water can be added if the compost is too dry. The rise in the temperature of the compost indicates intense microbial activity, indicating that the compost process is occurring. In fact, compost becomes so hot it can be used to heat greenhouses.

Vermicomposting is a special method of composting that uses earthworms in the compost unit (Figure 9.2). There are several benefits to adding worms. First, they accelerate the process of decomposition as they consume organic wastes. Second, their

FIGURE 9.2
Redworms (*Eisenia fetida*) from a
vermicompost unit



waste (worm castings) is an extremely effective and complete fertilizer. Special vermicompost units can be bought or built, and there is a wealth of information available. It is important to source worms from a reputable source, and to ensure that they have never eaten meat or wastes from animals. Once composted, the worm castings can be used directly in the plant nursery to start seeds as this will introduce the nutrients to the aquaponic system once the seedlings are transplanted. Alternately, the worm castings can be made into a compost tea.

Compost tea and secondary mineralization

When the organic waste has finally decomposed into humus, which can take 4–6 months, it is possible to make compost tea. The process is simple. Several large handfuls of compost are tied within a mesh bag, weighted with some stones. This bag is suspended in a bucket of water (20 litres). An air stone connected to a small air pump is positioned underneath the mesh bag so that the bubbles agitate the contents (Figure 9.3). The aeration is very important to prevent anaerobic fermentation from occurring. The mixture is left for several days with constant aeration. The contents should be stirred occasionally to prevent any anoxic areas. After

2–3 days, the compost tea is ready to be used in the unit. The tea should be strained through a fine cloth and then diluted 1:10 with water. Apply to the plants either as a foliar feed in a spraying canister or as liquid fertilizer straight to the plant roots. If adding the diluted tea straight into the unit, begin by using small amounts (50 ml) and patiently document the change in the plant growth. Re-apply when necessary, but be careful not to add too much.

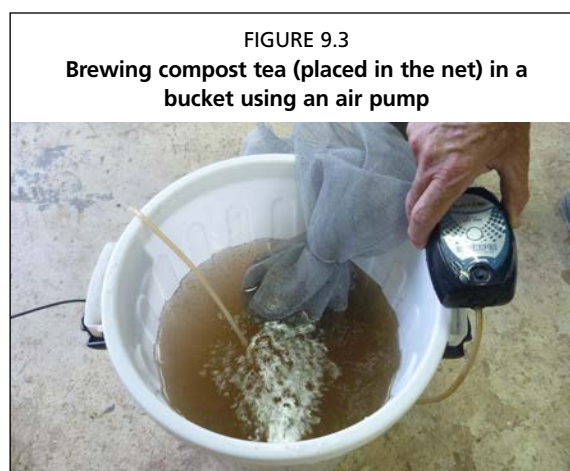

Other nutrient teas

In addition to compost, there are many other nutrient-rich organic materials that can be brewed into nutrient tea in the way explained above. One mentioned above is to use the solid wastes from the fish tank, captured from the mechanical filter. Brewed in the same way, the solid wastes are completely mineralized and available to add back to the aquaponic system. Other sources include seaweeds, nettles and comfrey. Seaweed is a great addition because it is rich in potassium and iron, which are often lacking in aquaponics, but be sure to rinse residual salt from the seaweed. Larger amounts of organic fertilizer teas can also be used to temporarily maintain the aquaponic system without fish. This may be useful in the colder months of the year when fish metabolism is low and the plants need a boost of nutrients.

Compost safety

When using compost make sure it is fully decomposed – making it pathogen-free. Never use organic sources from warm-blooded animals, which increases the risk of introducing pathogens. Moreover, make sure the water is well oxygenated and constantly aerated when producing the tea as this helps in mineralization and prevents some types of pathogenic bacteria from growing. Always avoid placing aquaponic water on the plants leaves, especially when using compost tea. For further information on brewing compost tea, see the section on Further Reading.

9.1.2 Alternative fish feed

Fish feed is one of the most important and expensive inputs for any aquaponic system. It can be purchased or self-made. The authors strongly recommend the use of quality manufactured fish feed pellets because they are a whole food for fish, meaning the pellets fulfill all the nutritional needs of the fish. Even so, below is an example of supplemental fish feed that can be easily produced domestically, which can help save money or used temporarily if manufactured feeds are not available or too expensive. Further information on creating homemade feed pellets is available in Appendix 5.

FIGURE 9.4
Duckweed growing in a container as fish feed supplement



FIGURE 9.5
Azolla spp. growing in a container as fish feed supplement



Duckweed

Duckweed is a fast-growing floating water plant that is rich in protein and can serve as a food source for carp and tilapia (Figure 9.4). Duckweed can double its mass every 1–2 days in optimum conditions, which means that one-half of the duckweed can be harvested every day. Duckweed should be grown in a separate tank from the fish because otherwise the fish would consume the whole stock. Aeration is not necessary and water should flow at a slow rate through the container. Duckweed can be grown in sun-exposed or half-shaded places. Surplus duckweed can be stored and frozen in bags for later use. Duckweed is also a useful feed for poultry.

Duckweed is a useful addition to an aquaponic system, especially if the duckweed-growing container is located along the return line between the plants grow beds and the fish tank. Any nutrients that escape the plant grow beds fertilize the duckweed, thereby ensuring the cleanest water possible returning to the fish. Duckweed does not fix atmospheric nitrogen, and all of the protein in the duckweed ultimately comes from the fish feed or other outside sources.

Azolla, a water fern

Azolla is a genus of fern that grows floating on the surface of the water, much in the manner of duckweed (Figure 9.5). The major difference is that *Azolla* is able to fix atmospheric nitrogen, essentially creating protein from the air. This occurs because *Azolla* has a symbiotic

relationship with a species of bacteria, *Anabaena azollae*, which is contained within the leaves. As well as providing a free source of protein, *Azolla* is an attractive feed source because of its exceptionally high growth rate. Like duckweed, *Azolla* should be grown in a separate tank with slow water flow. Its growth is often limited by phosphorus, so if *Azolla* is to be grown intensively an additional source of phosphorous is needed such as compost tea.

Insects

Insects are considered undesirable pests in many cultures. However, they have an enormous potential in supporting traditional food chains with more sustainable solutions. In many countries insects are already part of people's diets and sold at the markets. In addition they have been used as animal feed for centuries.

Insects are a healthy nutrient source because they are rich in protein and polyunsaturated fatty acids and full of essential minerals. Their crude protein content ranges between 13 and 77 percent (on average 40 percent) and varies according to the species, the growth stage and the rearing diet. Insects are also rich in essential amino acids, which are a limiting factor in many feed ingredients (Appendix 5). Edible insects are also a good source of lipids, as their quantity of fat can range between 9 and

67 percent. In many species, the content of essential polyunsaturated fatty acids is also high. These characteristics together make insects a healthy and ideal option for both human food and feed for animals or fish.

Given their enormous number and varieties, the choice of the insect to be reared can be tailored to their local availability, climatic conditions/seasonality and type of feed available. The source of food for insects can include staple husks, vegetable leaves, vegetable wastes, manure and even wood or cellulose-rich organic materials, which are suitable for termites. Insects also make a great contribution to waste biodegradation, as they break down organic matter until it is consumed by fungi and bacteria and mineralized into plant nutrients.

The culturing of insects is not as challenging as other animals since the only limiting factor is feed and not rearing space. Sometimes insects are referred to as “micro-livestock”. The small space requirement means that insect farms can be created with very limited areas and investment costs. In addition, insects are cold-blooded creatures, this means that their feed conversion efficiency into meat is much higher than terrestrial animals and similar to fish. There are plenty of options possible and additional knowledge on insect farming as feed in the section on Further Reading. Among the many species available, an interesting species to be used as fish feed is the black soldier fly (see below).

Black soldier flies

The larvae of black soldier flies, *Hermetia illucens*, are extremely high in protein and a valuable protein source for livestock, including fish (Figure 9.6). The lifecycle of this insect makes it a convenient and attractive addition to an integrated homestead farming system in favourable climate conditions. The larvae feed on manure, dead animals and food waste. When culturing black soldier flies, these types of waste are placed in a compost unit that has adequate drainage and airflow. As the larvae reach maturity, they crawl away from their feed source through a ramp installed in the compost unit that leads to a collection bucket. Essentially, the larvae devour wastes, accumulate protein and then harvest themselves. Two-thirds of the larvae can be processed into feed while the remaining one-third should be allowed to develop into adult flies in a separate area. The adult flies are not a vector of disease; adult flies do not have mouthparts, do not eat and are not attracted to any human activities. Adult flies simply mate and then return to the compost unit to lay eggs, dying after a week. Black soldier flies have been shown to prevent houseflies and blowflies in livestock facilities and can actually decrease the pathogen load in the compost. Even so, before feeding the larvae to the fish, the larvae should be processed for safety. Baking in an oven (170 °C for 1 hour) destroys any pathogens, and the resulting dried larvae can be ground and processed into a feed.

FIGURE 9.6
Black soldier fly (*Hermetia illucens*) adult (a) and larvae (b)



Moringa or kalamungay

Moringa oleifera is a species of tropical tree that is very high in nutrients, including proteins and vitamins. Classified by some as a super food and currently being used to combat malnutrition, it is a valuable addition to homemade fish feeds because of these essential nutrients. All parts of the tree are choice edibles suitable for human consumption, but for aquaculture it is typically the leaves that are used. In fact, there has been success in several small-scale aquaponic projects in Africa using leaves of this tree as the only source of feed for tilapia. These trees are fast-growing and drought-resistant and easily propagated through cuttings or seeds. However, they are intolerant of frost or freezing and not appropriate for cold areas. For leaf production, all of the branches are harvested down to the main trunk four times per year in a process called pollarding.

9.1.3 Seed collection

Collecting seeds from growing plants is another important cost-saving and sustainable strategy in many types of small-scale agriculture. It is especially effective for aquaponics because the plants are the primary production goal. Seed collection is a straightforward process, which is discussed here as two major categories, dry seed pods and wet seed pods. In general, only use seeds from mature plants. Young plant seeds will not germinate, and old plants will have already dispersed their seeds. Avoid hybrid plants, which may be sterile. Collecting from many plants helps retain genetic diversity and healthy plants. In addition, consider local seed exchange groups that are available to trade seeds with other small-scale farmers.

Dry seed pods

This subcategory includes basil, lettuce, salad rocket and broccoli. Seeds from some of these plants can be harvested throughout the growing cycle, e.g. basil (Figure 9.7).



Other seeds can only be collected after the plant is fully mature and no longer usable as a vegetable, e.g. lettuce and broccoli. The general process is to place the cut dry/mature stems into a large paper bag and store for 3–5 days in a cool, dark place. During this time, it is helpful to lightly shake the sealed paper bag to release the seeds. Next, open the bag and shake the stem or whole plant one final time while still inside the bag. Then, remove the stems and all plant debris and pass them through a sieve to collect the remaining seeds. Gather these seeds and place them back into the paper bag, making sure that only seeds and no plant debris remain.

Wet seed pods

This sub-category includes cucumbers, tomatoes and peppers. The seeds develop inside the actual fruit, usually coated in a gel sac, which prohibits seed germination. When the fruits are ready to harvest, usually indicated by a strong and vibrant colour, remove the fruit from the plant, slice open the fruit with a knife and collect the seeds inside using a spoon. Take the seeds coated with gel and place into a sieve and begin washing off the gel with water and a smooth cloth. Then, take the seeds and lay them out and dry them out in the shade, flipping them occasionally until they are totally dry. Finally, remove any remaining gel or plant debris and store them in a small paper bag.

Seed storage

It is recommended to store seeds inside sealed paper bags or envelopes in a cool, dry and dark place with a minimum of moisture. A small refrigerator is a perfect place to store seeds, best if in an air-tight container with a desiccant bag (i.e. silica gel) to keep moisture below the required levels for fungi to grow. It is vital to make sure that only seeds are present with no other plant or soil debris to remove the risk of disease or premature germination. Plant debris and moisture can also encourage fungus and mould that can damage the seeds. Once placed into the bags, write on bag the date and type of plant. For high percentages of seed germination, the seeds should be used within 2–3 growing seasons.

9.1.4 Rainwater harvesting

Collecting rainwater to resupply aquaponic units is another effective way of reducing running costs. There are several benefits to using rainwater for aquaponics. First and foremost, rain is free. The aquaponic systems described in this publication lose 1–3 percent of their water per day, mostly from transpiration through the plant leaves. Water is a precious resource and can be expensive and unreliable in some areas. Second, most rainwater is high quality. Rainwater is unlikely to have toxins or pathogens. Rainwater does not contain any salts. Rainwater also has low levels of GH and KH, and is typically slightly acidic. This is quite useful, especially in areas where water has a strong alkalinity, because rainwater may offset the need for acid correction of incoming water to keep the aquaponic system within the optimal 6.0–7.0 pH range. However, the lower KH of rainwater means that rainwater is a poor buffer against acid changes in pH. Therefore, if using rainwater as the main source of water, calcium carbonate should be added, as described in Section 3.5.2. Be conscientious about the water collection surface, and try to avoid collecting water from around bird roosts or wherever animal faeces accumulate. A simple method to reduce any risk of pathogen contamination is through slow sand filtration, which can be obtained by simply percolating water into a fine sand filter 50–60 cm high and collecting the filtered water at the bottom opening of the tank.

Rainwater collection can be easily achieved by connecting a large clean container to water drainage pipes surrounding a building or house (Figure 9.8). For example, a catchment area of 36 m² will collect 11 900 litres of water with as little as 330 mm of rainfall per year. Some of this water is lost, but enough is caught to be sufficient for a small-scale aquaponic unit. The units described here use, on average, 2 000–4 000 litres of water per year. Collecting rainwater is the easy part; storing rainwater is more important and can be more challenging. The water has to be retained until the system needs it, and the water has to be kept clean. The containers should be covered with a screen to prevent mosquitoes and plant debris from entering. It also helps to keep a few small guppies or tilapia fry in the rainwater to eat insects, and a single air stone prevents anoxic bacteria from developing.



9.1.5 Alternative building techniques for aquaponic units

Human ingenuity has provided countless variations on the basic theme of aquaponics. At its most basic sense, aquaponics is simply putting fish and vegetables in different containers with shared oxygenated water. Old water tanks, bathtubs, plastic barrels,



tables, wood and metal parts can all be used when building an aquaponic unit (Figure 9.9). Rafts and planting cups for DWC systems can be constructed from bamboo or recycled plastic; and media systems could be filled with locally available gravel. Always be sure that none of the components (fish tank, media beds, grow pipes and plumbing fittings) have been used previously to contain toxic or harmful substances that can hurt the fish, plants or humans. In addition, it is necessary to wash any material thoroughly before using it.

The least expensive aquaponic system consists of one large hole in the ground, lined with cheap 0.6 mm polyethylene plastic pond liner. This pond is separated with wire or mesh to separate the fish from the plants. One side of the pond is the fish tank, stocked with a relatively low density of fish, while the other is a DWC canal covered with polystyrene foam. Aeration and water movement are always required, but can be added either through an airlift with low head height or through human powered pumping. Lifting water up to a header tank and allowing it to cascade back down is one method of adding oxygen without electricity. This approach can be used in places where barrels and IBC containers are too expensive for farmers to consider using, although overall production would be lower.

Appendix 8 shows methods to make aquaponic units using IBCs, which can be easily found all around the world. In addition, the section on Further Reading lists two different guides on do-it-yourself aquaponics.

9.1.6 Alternative energy for aquaponic units

Operation of the unit's electric pumps, both air and water, requires an energy source. Usually, the normal power mains are used, but it is not mandatory. These systems can be operated completely using renewable energy. It is outside the scope of this publication to specify the plans for building renewable energy systems, but useful resources are listed in the section on Further Reading.

Photovoltaic electricity

Solar energy is an alternative and renewable energy that comes from sunlight. Photovoltaic panels convert the electromagnetic radiation from the sun to thermal energy or electricity (Figure 9.10). Water and air pumps for an aquaponic system can be powered with solar energy using photovoltaic solar cells, an AC/DC voltage inverter and large batteries to ensure 24 hour power supply at night or on cloudy days. Although highly sustainable, solar energy entails a large initial investment because of the costs of the extra equipment needed to convert and store the energy from photovoltaic cells. However, in some areas there are incentives to use solar energy which may help off-set these costs.

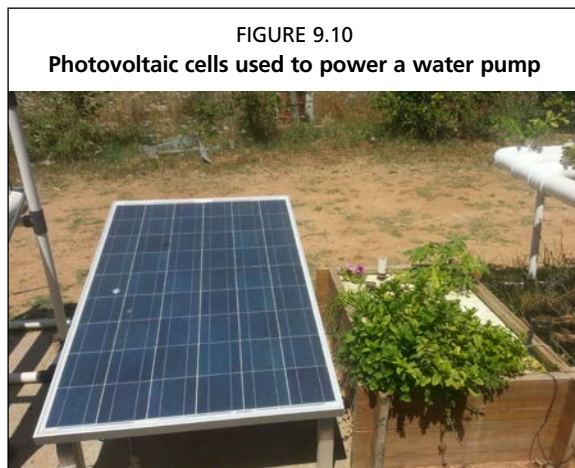

Although highly sustainable, solar energy entails a large initial investment because of the costs of the extra equipment needed to convert and store the energy from photovoltaic cells. However, in some areas there are incentives to use solar energy which may help off-set these costs.

Insulation

In winter, it may be necessary to heat the water. There are many methods to achieve this heating by using fossil fuels. However, cheaper and more sustainable options are available such as

tank insulation and spiral heating. Insulating the fish tanks with standard insulation during the winter months prevents heat dispersing from fish tank. Significant heat energy is actually dispersed from the activity of the air stones, thus it is best to cover and insulate the biofilter or adopt alternative aeration solutions that avoid air bubbling.

Spiral heating

Spiral heating is a form of passive heat capture from solar energy. Water from the system is circulated through black hose pipe, coiled in a spiral. The black plastic captures the heat from the sun and transfers it to the water. To further heat the system, the spiral heating coil can be contained within a small glass panel house that serves as a mini-greenhouse to further increase the heat. A black background can also help retain heat. For the systems described here, the recommended dimensions are a pipe 25 mm in diameter with a length of 40–80 m (Figure 9.11).



9.2 SECURING WATER LEVELS FOR A SMALL-SCALE UNIT

One of the most common disasters for small-scale or commercial aquaponic units is a loss-of-water event where all of the water drains from the unit. This can be catastrophic and kill all of the fish, destroying the system. There are several common ways for this to happen, including electricity cuts, blocked pipes, drains left open, forgetting to add new water or disruption of water flow by animals. All of these issues can be fatal for fish in a matter of hours if problems are not dealt with immediately. Below is a list of methods to prevent some of the above situations.

9.2.1 Float switches

Float switches are inexpensive devices used to control the pump depending on the water level (Figure 9.12). If the water level in the sump tank falls below a certain height, the switch will turn off the pump. This prevents the pump from pumping all of the water out of the tank. Similarly, float switches can be used to fill the aquaponic system with water from a hose or water main. A float switch similar to a toilet ballcock and valve can ensure that the water level never falls below a certain point. It should be noted that in certain types of loss-of-water events, such as a broken pipe, this method could ensure that the fish survive but actually make the flooding much worse, and it may not be appropriate for indoor applications.

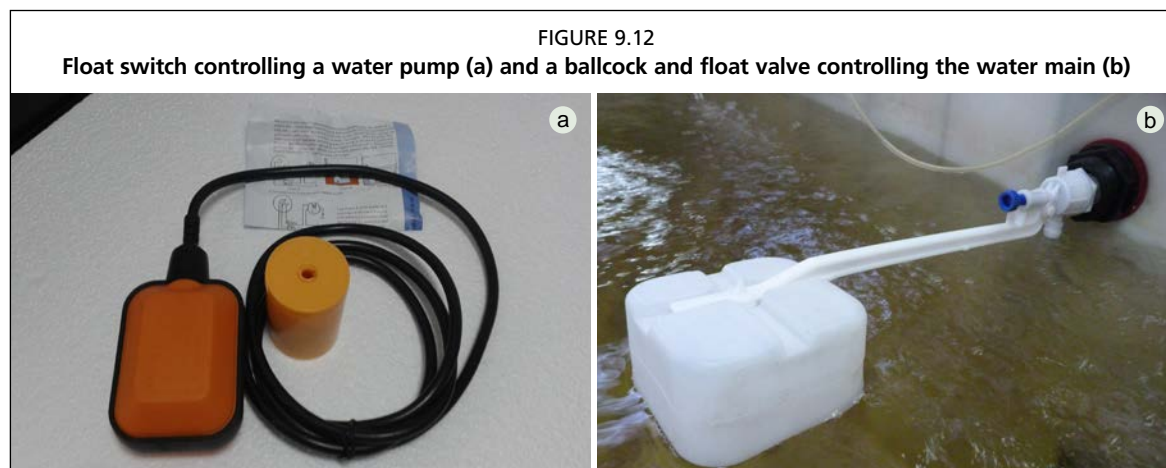

FIGURE 9.13
Overflow pipe on a biofilter



FIGURE 9.14
Stand pipe in a deep water culture canal
maintaining the water column height



9.2.2 Overflow pipes

Overflow pipes return water from the highest point in the unit back down to the sump in the event that the normal drainpipes become clogged (Figure 9.13). In these designs, the highest point is the fish tank, but other designs have the grow beds above the fish tank. Regardless, if pipes become blocked, which can occur if plant leaves, media or fish waste accumulate, the overflow pipes can safely drain water back down into the sump. This removes the risk of pumping the water out of the top of the system and draining the tanks.

9.2.3 Standpipes

Standpipes are used in bottom-draining tanks to prevent all of the water from draining out, typically installed in fish tanks. Within the tank in question, a vertical pipe is inserted into the drain (Figure 9.14). This technique defines the height of the water column; water neither gets deeper or shallower than the top of the pipe. However, this solution also means that the water from the bottom of the fish tank is not drained, unless a wider and taller pipe with wide openings at the bottom is positioned to concentrically surround the standpipe. By doing so, the water enters from the bottom and flows upward into the narrow interspace until it pours

out from the standpipe's top. This method is very secure, but requires that the outer pipe is occasionally moved to mobilize the wastes clogged in the interspace between the two pipes.

9.2.4 Animal fences

Opportunistic animals and birds can also cause loss of water by removing, displacing or breaking water pipes in the process of searching for water to drink or fish and vegetables to eat. To prevent this, a simple animal fence can be installed.

9.3 INTEGRATING AQUAPONICS WITH OTHER GARDENS

Aquaponics can be used alone, but it becomes a stronger tool for the small-scale farmer when used in conjunction with other agriculture techniques. It has already been discussed how other plants and insects can be grown to supplement the fishes' diet, but aquaponics can also help the rest of the garden. Generally, the nutrient-rich water from the aquaponic units can be shared among other plant production areas.

9.3.1 Irrigation and fertilization

Aquaponic units are a source of nutrient-rich water for vegetable production. This water can also be used to fertilize ornamental plants, lawns or trees. Aquaponic water is an excellent organic fertilizer for all soil-based production activities. For vegetables growing in raised beds or patches, aquaponic water can be periodically taken from the unit and irrigated onto the growing space, giving the soil a boost of essential nutrients for the vegetables. If growing larger fruiting vegetables (i.e. tomatoes) using satellite pots in the garden or in any space with good access to sunlight, aquaponic water

can also be used as a nitrate-rich fertilizer during the early stages of leaf and stem development. Aquaponic water is also good for seed starting.

9.3.2 Irrigating wicking beds

Wicking beds are another form of raised bed garden that are extremely water-efficient. The bed itself has a water reservoir at the bottom of the container filled with large gravel. Above this gravel is a good mixture of moisture-retaining soil. These two zones are usually separated with shade cloth, geotextile or other fabric. The plants are planted within the soil. A refill pipe leads down through the top zone of soil down into the bottom zone of the water reservoir. The water is drawn upward from the reservoir into the root zone by capillary action (Figure 9.15). This removes the need for overhead watering and much less water is lost through evaporation. Roots growing in the moist soil have a continuous supply of water, oxygen and nutrients. Wicking beds can be watered with standard water, but using aquaponic water also supplies nutrients and avoids the need for fertilizers. A valve installed at the bottom of wicking bed containers helps to periodically flush the water preventing the buildup of salts and/or anaerobic zones.

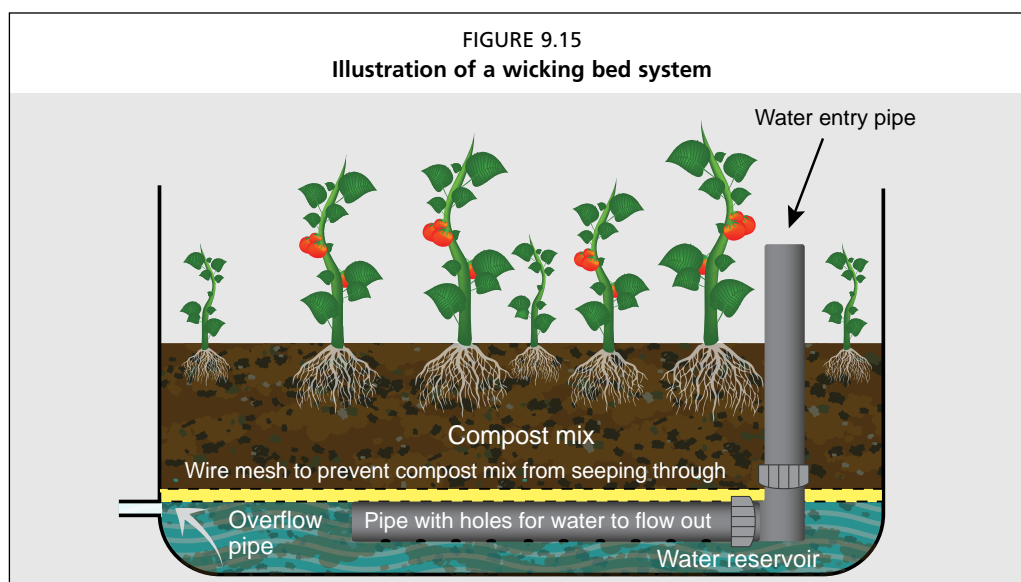

Wicking beds are an excellent method of growing vegetables in arid, water-scarce regions as only up to half of the water is needed compared with standard top-down irrigation methods. Wicking beds can be made out of water proof containers or dug into the ground and sealed with a polyethylene liner that stores the water, making them ideal methods to produce food in arid and semi-arid urban areas with little or no access to soil (Figure 9.16).

Another method is to place a wicking bed on top of a media bed within the aquaponic system proper. The fabric essentially creates a one-way passage, keeping soil out of the system but allowing water to percolate up into the root zone. This method can be used to grow tubers and root vegetables such as taro root, onions, beets and carrots. For further information on the wicking bed concept, see the sources listed in the section on Further Reading.



9.4 EXAMPLES OF SMALL-SCALE AQUAPONIC SETUPS

Aquaponics has been used successfully in a wide range of locations. Moreover, aquaponic techniques have been revised to meet diverse needs and goals of farmers beyond the common IBC or barrel methods (described throughout this publication). There are many examples, but these were chosen to highlight the adaptability and diversity of the aquaponic discipline.

9.4.1 Aquaponics for livelihood in Myanmar

A pilot-scale aquaponic system was built in Myanmar to promote micro-scale farming during the implementation of an e-Women project funded by the Italian Development Cooperation. The goal was to create a productive unit under low-tech and low-cost criteria by using locally available materials and stand-alone solar energy. The system hosted tilapia and a wide range of vegetables (Figure 9.17). The system was used for the development of a cost-benefit analysis, inclusive of depreciation, for household-scale systems with the objective to meet the daily income target of USD1.25 set by the Millennium Development Goal.

Using local prices, a 27 m² aquaponic system placed within a bamboo net house and powered by solar panel costs USD25/m². This system provides a net profit of USD1.6–2.2/day from vegetables, and a daily ration of 400 g of tilapia for home consumption. The payback period is 8.5–12 months depending on the crops. The net house prevents any need for pest control and avoids seasonality by securing income against adverse climatic conditions (rain). Fry nursing, very common among farmers in Southeast Asia, could be another interesting option in aquaponics to further boost incomes in poor or landless households.

This pilot project showed that aquaponics could play an important role in securing food and livelihood in many areas across the world. The production of fish and plants with small plots allows vulnerable people to produce income, adds value to household work and empowers women at community level.

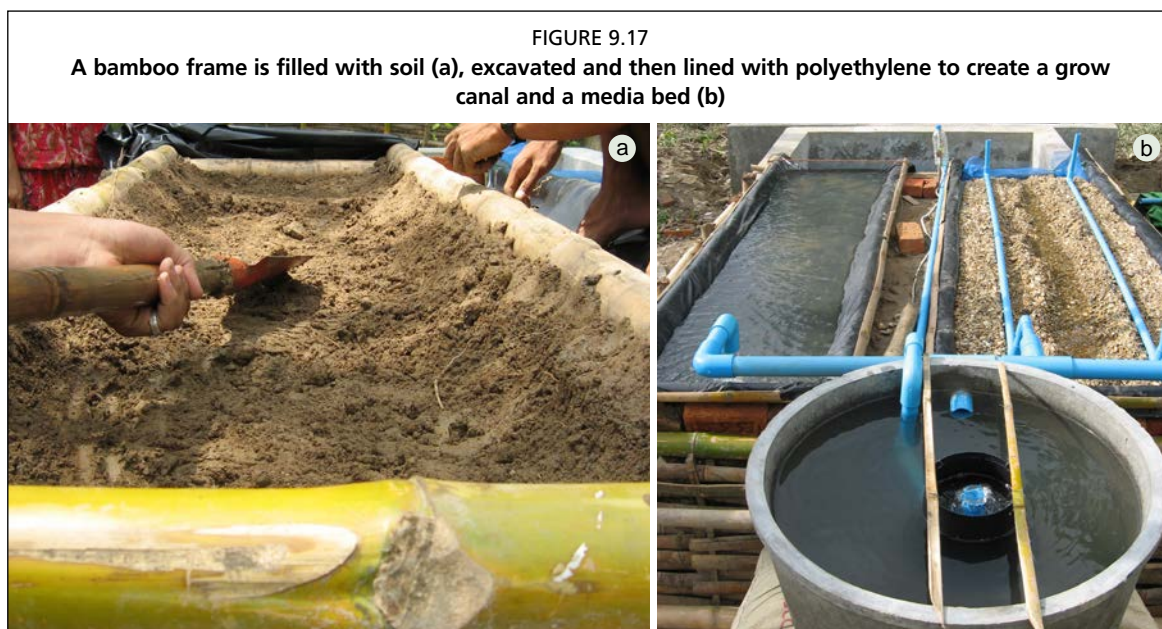

9.4.2 Saline aquaponics

The integration of marine or brackish water aquaculture with agriculture provides new ways to produce food in coastal or saline-prone areas where traditional farming cannot be developed. The inland culturing of aquatic animals, beyond the environmental benefits derived from pollution or landscape restoration, is beneficial for the

greater control of the production factors and the reduction of the risks related to contaminants or pathogens. Even though saltwater is not ideal for plants, as it creates osmotic shocks, limits growth and procures sodium toxicity, it is still possible to grow some useful plants in lower salinity.

A wide range of plants can benefit from the nutrient-rich water obtainable from aquaponics or closed recirculating systems. Halophytes (salt-tolerant species) can boost food output in arid and saline areas and raise farm productivity. Some species are highly-valued speciality crops, such as *Salsola* spp. (Figure 9.18), sea fennel, *Atriplex* spp. or *Salicornia* spp., while other are cropped for grains, such as pearl millet, quinoa and eelgrass, and still others can be grown for biodiesel. Ideal saline conditions for halophytes are in the salinity range of one-third to one-half of sea strength, but some plants are tolerant to hypersaline conditions.

Adapting horticultural plants to saline water is one of the greatest challenges of modern agriculture. However, it is possible to grow some horticultural species directly with brackish-water. Most of the plants belonging to the *Chenopodiaceae* family (beet, chard) can easily grow in a salinity of one-sixth to one-third of sea strength owing to their higher resistance to salt (Figure 9.19). Other common species such as tomato and basil can achieve substantial production up to one-tenth of sea strength (Figure 9.20) providing that tailored agronomic strategies are adopted: increased concentrations of nutrients, plant bio-conditioning, grafting with salt-tolerant rootstocks, improved climate control and higher planting densities. Nevertheless, the qualitative traits of saline crops are higher than freshwater, both for their organoleptic characteristics, taste and shelf-life.

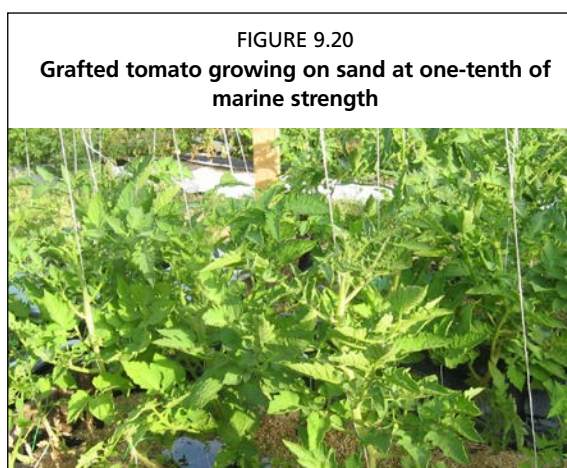
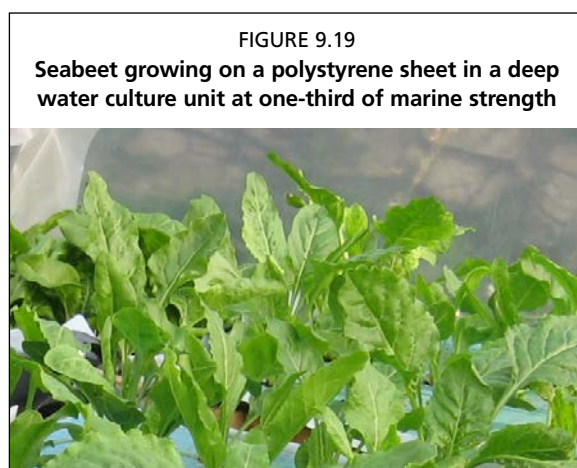
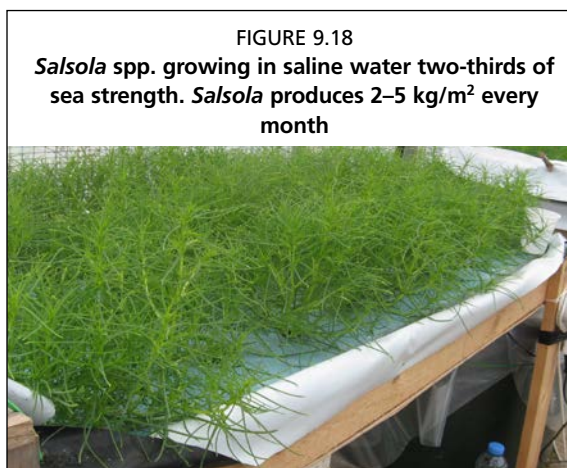

9.4.3 Bumina and Yumina

There is an aquaponic technique from Indonesia that deserves special attention. In Bahasa Indonesia, this technique is called *bumina* and *yumina*, translated literally as “fruit–fish” and “vegetable–fish”. This name demonstrates how intimately linked the plants and the fish are within an aquaponic system. Bumina and yumina are essentially a version of the media bed technique.

The fish are housed within an in-ground pond dug into the earth and lined with sandbags or hollow-form bricks. This pond is lined with a tarp, or better, a polyethylene liner. The liner is necessary to prevent unwanted biological and chemical reactions occurring within the sediments on the bottom and helps to keep the system clean. Alternately, the fish are housed within a raised concrete cistern. Water is pumped out of this pond into a header tank, usually constructed out of a large plastic barrel. This barrel can contain mechanical and biological filter material if the stocking density is high enough to require it. From this header barrel, the water is fed, by gravity, through a distribution pipe. The entire pond is lined with satellite pots, simple flower pots or other small containers that are full of organic growing media. The distribution pipe lays atop these satellite pots and water is delivered through small holes. The water irrigates and fertilizes the plants in these pots, and then exits the bottom of the pots back into the fish pond (Figure 9.21). The cascading water effect also helps to aerate the fish pond.

Bumina and yumina are used as an important component of homestead food security initiatives throughout Indonesia aimed at increasing home protein production. The initial investment of these systems is smaller than that of the IBC systems outlined in this publication, but they require an in-ground pond so are inapplicable for some urban, indoor or rooftop applications.

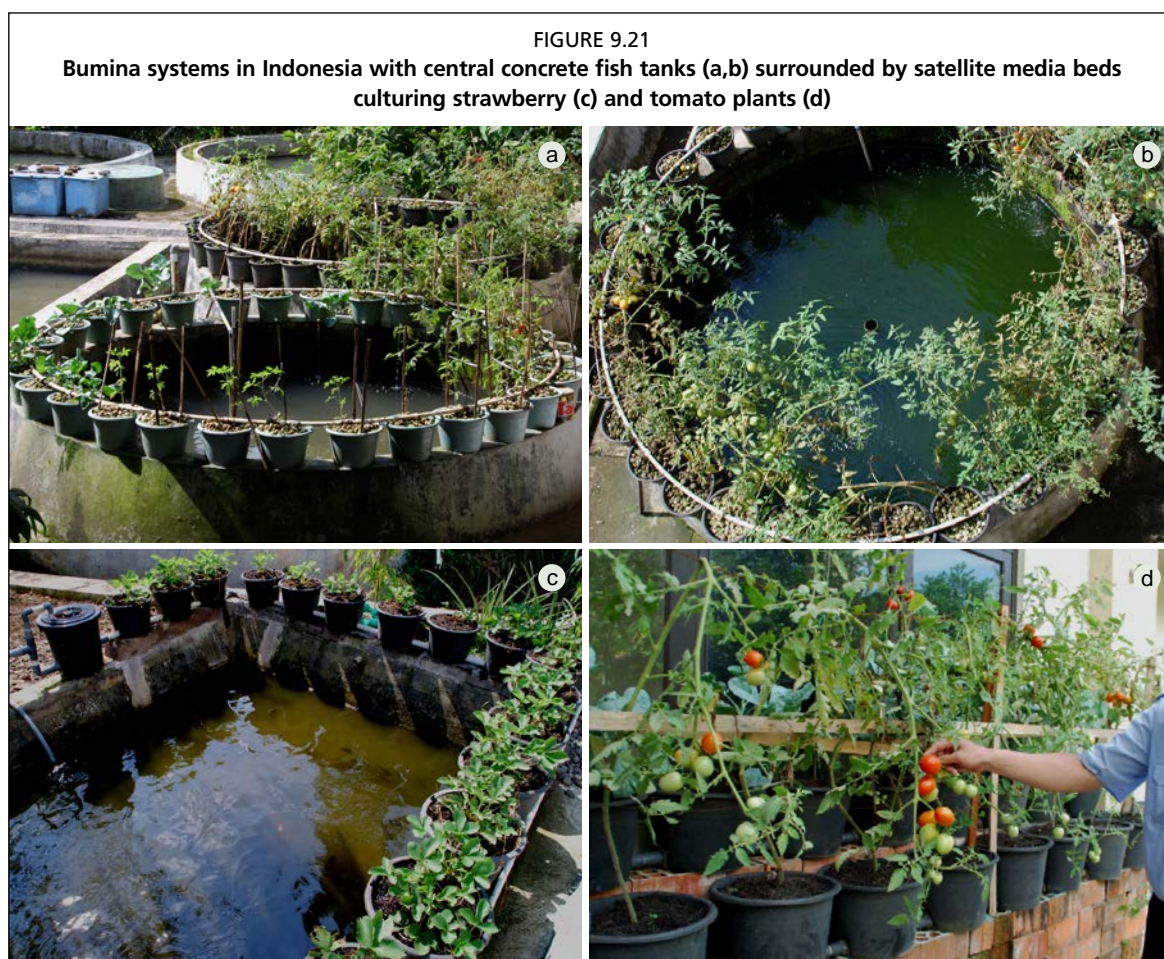

9.5 CHAPTER SUMMARY

- Compost tea can be used to supplement nutrients for the plants and be produced on a small-scale by composting vegetable wastes.
- Alternative and supplemental fish feed can be grown and produced on a small-scale, including duckweed, *Azolla* spp., insects and moringa.
- Seeds can be collected and stored using simple techniques to reduce costs of reseeding.
- Rainwater collection and storage provides a cost-effective way of replenishing aquaponic water.
- Redundancies and failsafe methods should be employed to prevent catastrophic loss-of-water events that can kill the fish.
- Aquaponic water can be used to fertilize and irrigate other gardening activities.
- Many types and methods of aquaponics exist beyond the examples outlined in this publication.

Further reading

Recirculating aquaculture and fish breeding

- Lim, C. & Webster, C.D. 2006. *Tilapia: biology, culture, and nutrition*. Bing Hampton, USA, Haworth Press. 678 pp.
- Timmons, M.B. & Ebeling, J.M. 2010. *Recirculating aquaculture*. Ithaca, USA, Cayuga Aqua Ventures. 975 pp.
- Szyper, J.P., Tamaru, C.S., Howerton, R.D., Hopkins, K.D., Fast, A.W. & Weidenbach, R.P. 2001. *Maturation, hatchery and nursery techniques for Chinese catfish, Clarias fuscus, in Hawaii*. Aquaculture Extension Bulletin. University of Hawaii Sea Grant College Program.
- Woyanovich, A., Moth-Poulsen, T. & Péteri, A. 2010. *Carp polyculture in Central and Eastern Europe, the Caucasus and Central Asia: A manual*. FAO Fisheries and Aquaculture Technical Paper. No. 554. Rome, FAO. 73 pp.
(also available at: www.fao.org/docrep/013/i1794e/i1794e00.htm).

Species profiles

- FAO. 2014. Species profiles. In: *FAO Aquaculture Feed and Fertilizer Resources Information System* [online]. Rome. [Cited 2 September 2014].
www.fao.org/fishery/affris/species-profiles/en/
- FAO. 2014. Nile tilapia - *Oreochromis niloticus*. In: *FAO Aquaculture Feed and Fertilizer Resources Information System* [online]. Rome. [Cited 2 September 2014].
www.fao.org/fishery/affris/species-profiles/nile-tilapia/nile-tilapia-home/en/
- FAO. 2014. Common carp - *Cyprinus carpio*. In: *FAO Aquaculture Feed and Fertilizer Resources Information System* [online]. Rome. [Cited 2 September 2014].
www.fao.org/fishery/affris/species-profiles/common-carp/common-carp-home/en/

Aquaponics

- Backyard Aquaponics. 2011. *The IBC of aquaponics* [online]. Edition 1.0. Backyard Aquaponics, Success Western, Australia.
Available at: www.backyardaquaponics.com/Travis/IBCOfAquaponics1.pdf
- Bailey, D.S., Rakocy, J.E., Cole, W.M. & Shultz, K.A. 1997. Economic analysis of a commercial-scale aquaponic system for the production of tilapia and lettuce. In: *Tilapia Aquaculture: Proceedings of the Fourth International Symposium on Tilapia in Aquaculture, Orlando, Florida*.
- Bernstein, S. 2011. *Aquaponic gardening: a step-by-step guide to raising vegetables and fish together*. Gabriola Island, Canada, New Society Publishers. 255 pp.
- Danaher, J.J., Pantanella, E., Rakocy, J.E., Shultz, R.C. & Bailey, D.S. 2011. *Dewatering and composting aquaculture waste as a growing medium in the nursery production of tomato plants*. Acta Hort. (ISHS) 891. pp. 223–229.
- Diver, S. 2007. *Aquaponics-integration of hydroponics with aquaculture*. ATTRA – National Sustainable Agriculture Information Service. 46 pp.
- Gloger, K.C., Rakocy, J.E., Cotner, J.B., Bailey, D.S., Cole, W.M. & Shultz, K.A. 1995. *Waste treatment capacity of raft hydroponics in a closed recirculating fish culture system*. World Aquaculture Society, Book of Abstracts. pp. 126–127.
- Hughey, T.W. 2005. *Barrel-ponics (a.k.a. aquaponics in a barrel)* [online].
Available at: www.aces.edu/dept/fisheries/education/documents/barrel-ponics.pdf

- Lennard, W.A. & Leonard, B.V. 2006. A comparison of three different hydroponic subsystems (gravel bed, floating and nutrient film technique) in an aquaponic test system. *Aquaculture International*, 14(6): 539–550.
- Pantarella, E. 2012. Integrated marine aquaculture-agriculture: sea farming out of the sea. *Global Aquaculture Advocate*, 15(1): 70–72.
- Pantarella, E., Cardarelli, M. & Colla, G. 2012. Yields and nutrient uptake from three aquaponic sub-systems (floating, NFT and substrate) under two different protein diets. *In: Proceedings. AQUA2012. Global Aquaculture securing our future. Prague, Czech Republic 1-5 Sept 2012.*
- Pantarella, E., Cardarelli, M., Colla, G., Rea, E. & Marcucci, A. 2011. *Aquaponics vs hydroponics: production and quality of lettuce crop.* Acta Hort. 927. pp. 887–893.
- Rakocy, J.E. 2007. Aquaponics, integrating fish and plant culture. *In* T.B. Simmons & J.M. Ebeling, eds. *Recirculating aquaculture*, pp. 767–826. Ithaca, USA, Cayuga Aqua Ventures.
- Rakocy, J.E. 2007. Ten guidelines for aquaponic systems. *Aquaponics Journal*, 46: 14–17.
- Rakocy, J. E., Masser, M.P. & Losordo, T.M. 2006. *Recirculating aquaculture tank production systems: aquaponics-integrating fish and plant culture.* SRAC publication 454. 1–16.
- Rakocy, J.E, Masser, M.P. & Losordo, T.M. 2006. *Recirculating aquaculture tank production systems: aquaponics-integrating fish and plant culture.* SRAC Publication No. 454 (revision November 2006). USA, Department of Agriculture.
- Rakocy, J.E., Shultz, R.C., Bailey, D.S. & Thoman, E.S. 2004. *Aquaponic production of tilapia and basil: comparing a batch and staggered cropping system.* Acta Horticulturae 648. pp. 63–69.
- Savidov, N. 2005. *Evaluation and development of aquaponics production and product market capabilities in Alberta.* Phase II. Final Report - Project #2004-67905621.
- Seawright, D.E., Stickney, R.R. & Walker, R.B. 1998. Nutrient dynamics in integrated aquaculture-hydroponic systems. *Aquaculture*, 160: 215–237.
- Tyson, R.V., Simonne, E.H., White, J.M. & Lamb, E.M. 2004. Reconciling water quality parameters impacting nitrification in aquaponics: the pH levels. *Proc. Fla. State Hort. Soc.*, 117: 79–83.

Bacteria, microbes and the nitrogen cycle

- Carmignani, G.M. & Bennett, J.P. 1977. Rapid start-up of a biological filter in a closed aquaculture system. *Aquaculture*, 11(1): 85–88.
- Crab, R., Avnimelech, Y., Defoirdt, T., Bossier, P. & Verstraete, W. 2007. Nitrogen removal techniques in aquaculture for a sustainable production. *Aquaculture*, 270: 1–14.
- Hargreaves, J.A. 1998. Nitrogen biogeochemistry of aquaculture ponds. *Aquaculture*, 166: 181–212.
- Lewis, W. & Lowenfels, J. 2010. *Teaming with microbes: a gardener's guide to the soil food web.* Portland, USA, Timber Press. 220 pp.

Bell siphon design and construction

- Fox, B.K., Howerton, R. & Tamaru, C.S. 2010. *Construction of automatic bell siphons for backyard aquaponic systems.* Cooperative Extension Service, College of Tropical Agriculture and Human Resources, University of Hawaii at Mānoa.
- Lennard, W.A. & Leonard, B.V. 2004. A comparison of reciprocating flow versus constant flow in an integrated, gravel bed, aquaponic test system. *Aquaculture International*, 12: 539–553.

Fish feeds

- Bondari, K. & Sheppard, D.C. 1981. Soldier fly larvae as feed in commercial fish production. *Aquaculture*, 24: 103–109.

- FAO. 1983. FAO composition of feedstuff (Table 1). In: *Fish feeds and feeding in developing countries*. ADCP/REP/83/18. Rome. (also available at: www.fao.org/docrep/q3567e/q3567e03.htm#2.2%20composition%20of%20feedstuffs).
- FAO. 2013. *Edible insects: future prospects for food and feed security*. FAO Forestry Paper 171. Rome. 187 pp.
(also available at: www.fao.org/docrep/018/i3253e/i3253e00.htm).
- FAO. 2014. FAO feed resources database. In: *FAO Aquaculture Feed and Fertilizer Resources Information System* [online]. Rome. [Cited 2 September 2014].
www.fao.org/fishery/affris/feed-resources-database/en/
- Fasakin, E.A., Balogun, A.M. & Fasuru, B.E. 1999. Use of duckweed, *Spirodela polyrrhiza* L. Schleiden, as a protein feedstuff in practical diets for tilapia, *Oreochromis niloticus* L. *Aquaculture Research*, 30(5): 313–318.
- Hasan, M.R. & Chakrabarti, R. 2009. *Use of algae and aquatic macrophytes as feed in small-scale aquaculture: A review*. FAO Fisheries and Aquaculture Technical Paper. No. 531. Rome, FAO. 123 pp.
(also available at: www.fao.org/docrep/012/i1141e/i1141e00.htm).
- New, M.B. 1987. *Feed and feeding of fish and shrimp*. ADCP/REP/87/26. Rome, FAO.
(also available at: www.fao.org/docrep/s4314e/s4314e00.htm#Contents).
- NRC. 1993. *Nutrient requirement of fish*. Washington, DC, National Academy Press. 126 pp.
- Richter, N., Siddhuraju, P. & Becker, K. 2003. Evaluation of nutritional quality of moringa (*Moringa oleifera* Lam.) leaves as an alternative protein source for Nile tilapia (*Oreochromis niloticus* L.). *Aquaculture*, 217(1): 599–611.
- Sheppard, D.C., Tomberlin, J.K., Joyce, J.A., Kiser, B.C. & Sumner, S.M. 2002. Rearing methods for the black soldier fly (Diptera: Stratiomyidae). *J. Med. Entomol.*, 39(4): 695–698.
- Sophie St-Hilaire, I.S., Cranfill, K., McGuire, M.A., Mosley, E.E., Tomberlin, J.K., Newton, L., Sealey, W., Sheppard, C. & Irving, S. 2007. Fish offal recycling by the black soldier fly produces a foodstuff high in omega-3 fatty acids. *Journal of the World Aquaculture Society*, 38(2): 309–313.
- Wagner, G.M. 1997. *Azolla*: a review of its biology and utilization. *Botanical Review*, 63(1): 1–26.

Compost tea

- Brewing Compost Tea.** Fine Gardening. Brewing Compost Tea by Elaine Ingham. Available at: www.finegardening.com/brewing-compost-tea.
- Ingham, E.R. 2000. *The compost tea brewing manual*. Fifth edition. Corvallis, USA, Soil Foodweb Incorporated. 79 pp.

Fish diseases

- Bondad-Reantaso, M.G., McGladdery, S.E., East, I. & Subasinghe, R.P., Eds. 2001. *Asia Diagnostic Guide to Aquatic Animal Diseases*. FAO Fisheries Technical Paper. No. 402, Supplement 2. Rome, FAO. 240 pp.
(also available at: www.fao.org/docrep/005/y1679e/y1679e00.htm).
- Noga, E.J. 1996. *Fish disease, diagnosis and treatment*. St. Louis, USA, Mosby Year-Book inc. 367 pp.

Greenhouses and net houses

- FAO. 1999. *Greenhouses and shelter structures for the tropics*. Plant Production and Protection Paper 154. Rome. 138 pp.
- FAO. 2013. *Good agriculture practices for greenhouse vegetable production: Principles for the Mediterranean climate areas*. Plant Production and Protection Paper 217. Rome. 621 pp. (also available at: www.fao.org/docrep/018/i3284e/i3284e.pdf)

Nutrient deficiencies

- Bennett, W.F.** 1993. *Nutrient deficiencies and toxicities in crop plants*. St. Paul, USA, American Phytopathological Society. 202 pp.
- Berry, W.** 2010. *Symptoms of deficiency in essential minerals* [online]. UCLA. Lincoln Plant Physiology online. Fifth edition.
Available at: <http://5e.plantphys.net/article.php?ch=t&id=289>

Plant diseases

- Agrios, G.N.** 2004. *Plant pathology*. Fifth edition. Burlington, USA, Elsevier Academic Press. 933 pp.
- Copping, L.G.** 2004. *The manual of biocontrol agents*. Third edition. Alton, UK, BCPC publications. 702 pp.
- Cornell University.** *Plant Disease Diagnostic Clinic* [online].
Available at: <http://plantclinic.cornell.edu/factsheets.html>
- IFOAM.** 2012. *The IFOAM norms for organic production and processing*. Bonn, Germany. 132 pp.
- Pal, K.K. & McSpadden Gardener, B.** 2006. *Biological control of plant pathogens*. The Plant Health Instructor DOI: 10.1094/PHI-A-2006-1117-02. pp. 1-25.
- Soil Association.** 2011. *Material for pest and disease control in organic crops*. Fact sheet. Bristol, UK, Soil Association Trade and Producer Support. 18 pp.
- Texas A&M Agrilife Extension.** *Texas plant disease handbook* [online].
Available at: <http://plantdiseasehandbook.tamu.edu/food-crops/vegetable-crops/>

Pest management

- ATTRA National Sustainable Agriculture Information Service.** Pest management [online]. Available at: <https://attra.ncat.org/pest.html>
- Colorado State University Extension.** *Insect publication* [online].
Available at: www.ext.colostate.edu/pubs/pubs.html#insects
- Cranshaw, W.S.** 2008. *Bacillus thuringiensis* [online]. Factsheet 5.556. Colorado State University Extension. Available at: www.ext.colostate.edu/pubs/insect/05556.html
- Ellis, B.W. & Bradley, F.M.** 1996. *The organic gardener's handbook of natural insect and disease control*. Emmaus, USA, Rodale Press Inc. 544 pp.
- Kogan, M.** 1998. Integrated pest management: historical perspectives and contemporary developments. *Annual Review of Entomology*, 43(1): 243–270.
- Olkowski, W., Dietrick, E., Olkowski, H. & Quarles, W.** 2003. Commercially available biological control agents. *IPM Practitioner*, 25: 1–9.
- Rondon, S.I., Cantliffe, D.J. & Price, J.** 2001. Augmentative biological control of insects: possibilities for vegetable greenhouse producers. *FACTS Proceedings 2001*, pp. 15–16.
- Shour, M.H.** 2000. *Pesticides from nature* [online]. Iowa State University Extension. Available at: www.extension.iastate.edu/newsrel/2000/aug00/aug0007.html
- Washington State University (WSU).** 2011. *Organic pest control in the vegetable garden* [online]. Community Horticulture Fact Sheet #13. King County Extension. Available at: <http://ext100.wsu.edu/king/wp-content/uploads/sites/17/2014/02/Organic-Pest-Control-in-the-Vegetable-Garden1.pdf>
- UW Madison Department of Entomology.** *Insect ID* [online].
Available at: www.entomology.wisc.edu/insectid/index.php

Soil-less culture

- Cooper, A.** 1979. *The ABC of NFT. Nutrient film technique. The world's first method of crop production without a solid rooting medium*. Portland, USA, Intl Specialized Book Service Inc. 181 pp.
- Raviv, M. & Lieth, J.H.** 2008. *Soil-less culture: theory and practice*. First edition. London, Elsevier Publishing. 608 pp.

Resh, H.M. 2004. *Hydroponic food production. A definitive guidebook for the advanced home gardener and the commercial hydroponic grower*. Sixth edition. Mahwah, USA, Newconcept Press. 567 pp.

Wicking beds

Sullivan, C., Hallaran, T., Sogorka, G. & Weinkle, K. 2014. An evaluation of conventional and subirrigated planters for urban agriculture: Supporting evidence. *Renewable Agriculture and Food Systems*, 1–9.

Wicking bed. *Wicking bed – a new technology for adapting to climate change* [online]. pp. 1–14. Available at: www.waterright.com.au/wicking_bed_technology.pdf

Wicking worm bed. *Wicking worm bed. Basic principles* [online]. pp. 1–10. Available at: www.waterright.com.au/Wicking%20worm%20beds.pdf

Glossary

- Acid** – A substance characterized by the ability to react with bases or alkalis in water to form salts. An acid releases hydrogen ions upon dissociation in water, having a pH of less than seven.
- AC/DC** – A type of electrical device that can function both with alternating current (AC), such as that from a wall socket, and direct current (DC), such as that from a battery. Usually used in regard to battery-based backup systems for aerators and water pumps.
- Aerobic** – A condition or process where gaseous oxygen is present or required. Aerobic organisms obtain energy for growth from aerobic respiration.
- Alkalinity** – Amount of alkaline minerals (acid binding) that a solution has in the water to neutralize hydrogen ions. It is usually expressed as SBV units (abbreviation of the German term Säurebindungsvermögen) or equivalents of calcium carbonate under the conversion factor of 1 SBV = 50 mg eq. CaCO₃/litre. Alkalinity is measured by using methyl orange as an indicator, whose variation in colour at pH 4.2–4.4 indicates, by definition, the complete depletion of alkali.
- Anaerobic** – Referring to a condition or process where gaseous oxygen is not present or not necessary.
- Autosiphon** – A device that automatically floods and drains a water tank without a timer or moving parts. Incoming water fills the tank in question until it reaches the critical height set by the siphon; this starts pulling water out of the tank with an outflow faster than the inflow, which eventually empties the tank and lets air enter the device to break the draining and allow the tank to refill.
- Base** – A substance characterized by the ability to react with acids or hydrogen ions in water to form salts. A base releases hydroxide ions upon dissociation in water and has a pH of higher than seven.
- Balance** – A state of dynamic equilibrium in an integrated agricultural system, such as aquaponics, where the various biological and chemical processes remain stable over time.
- Biofouling** – Accumulation of organisms on wet surfaces that can affect their functioning.
- Biological filter (biofilter)** – The component of the treatment units of an aquaculture system in which organic pollutants are decomposed (mainly oxidized) as a result of microbiological activity. The most important processes are the degradation of nitrogen metabolites by heterotrophic bacteria and the oxidation of ammonia via nitrite to nitrate.
- Biomass ratio** – The optimal balance between the fish and plants to obtain good fish and vegetable growth. It is expressed as the plant growing area that can be supported given a certain feeding rate.
- Buffering (acid binding capacity)** – The capacity of a solution containing a weak base and its conjugated acid to resist falls in pH when small quantities of an acid are added. The buffering occurs within a specific pH range and capacity that depends on the amount of alkali present in the solution. In aquaponics, the buffering occurs with carbonate or bicarbonate ions binding hydrogen ions from nitric acid until they all become saturated into carbonic acid, their weak conjugated acid form.
- Carnivore** – An animal that feeds mainly on the tissues of other animals.
- Clarifier** – A sedimentation tank built to remove suspended solids from the water by means of settling or separation from the aqueous media.

- Chelate** – A molecular association of a metal ion and a larger ligand, typically making the ion more soluble and biologically available.
- Denitrification** – The biochemical reduction of nitrate via the intermediate nitrite to molecular (gaseous) nitrogen and carbon dioxide through microbiological activity. In aquaculture: a necessary water treatment process in recycling systems from nitrogen buildup with little or no water exchange; also occurs in settling tanks, suspended solid traps and water storage tanks.
- Feed rate ratio** – The ratio that helps balance an aquaponics system, relating the amount of feed added to the amount of plant growing area.
- Flood and drain** – A method controlling the water flow in a hydroponic or aquaponic grow bed where the media is alternatively submerged and drained with water, which ensures both adequate aeration of the plant roots and bacterial colonies while distributing water and nutrients equally. Also known as ebb and flow.
- Footprint** – A resource-measuring tool to determine the amount of land or water needed to support with resources a community or an activity and to assimilate the waste produced. Higher sustainability is obtained when a smaller footprint is required to obtain the same product by using a different technology or to support a community by adopting more sound management.
- Granulometry** – A description of the size classes in a group of granular material with implications for surface area to volume ration.
- Hardness** – Measure of the concentrations of dissolved ions of calcium and magnesium in the water. Hardness is expressed as equivalent of calcium carbonate in milligrams per litre (mg/litre). Hardness can be also expressed as milliequivalent per litre, German hardness (°dH) or mg/litre of calcium oxide (CaO) according to the following conversion factor: $50 \text{ mg/litre CaCO}_3 = 1 \text{ meq/litre} = 2.805 \text{ (°dH)} = 28 \text{ mg/litre CaO}$.
- Head, head pressure** – In hydraulics: the measurement of pressure of water expressed in height at which water is held or can rise to, allowing it to flow to lower levels, push through pipes, etc.
- Header tank** – A water tank kept at a height for supplying water to lower rearing units, for example hatchery incubators and nursery tanks.
- Herbivore** – An animal that feeds mainly on plant material.
- Hydroponics** – A form of soil-less agriculture where plants are provided a nutrient solution containing all essential macronutrients and micronutrients necessary for growth, either through irrigation of inert media or directly within tanks of nutrient solution.
- Ion** – An atom or radical with an electrical charge that is positive (cation) or negative (anion) as a result of having lost or gained electrons.
- Molecular nitrogen** – An odourless gaseous element that makes up 78 percent of the Earth's atmosphere, and is a constituent of all living tissue. It is almost inert in its gaseous form.
- New tank syndrome** – A common condition in newly installed aquaculture and aquarium systems with insufficient or immature biofiltration capabilities resulting in accumulation of toxic ammonia and nitrite, causing fish stress and ultimate death.
- Nitrification** – The aerobic bacterial conversion (oxidation) of ammonia and organic nitrogen to stable salts (nitrates), via bacteria, often *Nitrosomonas* spp. and *Nitrobacter* spp.
- Nitrogen-fixation** – The process by which certain bacteria and cyanobacteria are able to convert atmospheric nitrogen into combined forms into the soil, making them available to plants.

- Nutrient cycle (nitrogen cycle)** – Biogeochemical cycle, in which inorganic nutrients move through the soil, living organisms, air and water. In agriculture, it refers to the return back to the soil of nutrients absorbed by plants from the soil. Nutrient cycling can take place through leaf fall, root exudation (secretion), residue recycling, incorporation of green manures, etc.
- Nutrient lockout (pH-dependent nutrient availability)** – An effect of pH and soil chemistry on the bioavailability of nutrients to be absorbed by plants, especially important in hydroponics and aquaponics. Each nutrient has a pH range in which it is available, but outside this range the plants will not be able to use the nutrients despite their presence in the nutrient solution.
- Omnivore** – An animal that consumes both plant and animal material.
- Oxidation** – Type of chemical reaction, always coupled with reduction, in which the molecule in question loses an electron, often binding with oxygen. Examples include the burning of wood or the rusting of iron.
- Photoperiodism** – The physiological response of plants and animals to the seasonal length of days and nights. In plants, the presence of photoreceptors informs the plants of the optimal period to flower. Photoperiodic plants can start their flowering either with long or short days depending on the species. In animals, photoperiodism together with temperature regulate the physiological changes in sexual behaviour, migration and hibernation.
- Reduction** – Type of chemical reaction, always coupled with oxidation, in which the molecule in question gains an electron, often losing an oxygen molecule, atom or ion.
- Soil-less agriculture (hydroponics)** – The growing of plants without soil. Plants are fed with an aerated solution of nutrients, and the roots are either supported within an inert matrix, or are freely floating in the nutrient solution.
- Soil tiredness** – A condition in soils that lead to a progressive reduction in yields after repeated cultivation of the same crop on the same area. The condition is due to a combination of nutrient depletion, exploitation of soil structure (low organic matter), accumulation of pathogens (parasites, pests, bacteria, fungi) specifically targeting the crop, selection of species-specific weeds and accumulation of inhibiting root exudates.
- Soluble** – The ability of a substance to be dissolved in water or other liquid media, typically dependent on the charge and size of its molecules and the charge of the liquid. The more uncharged and the larger the molecules are, the less soluble in water is the substance.
- Specific surface area** – A metric to describe how much surface area is exposed for each unit of volume of an object alone or in a set. The value provides an indirect reading of porosity and granulometry of an object and is especially important for chemical reaction and biological activity, with a high ratio providing more area for the action in question.
- Stocking density** – Usually an expression of the number of fish per unit area or weight of fish per unit of volume of water at stocking.
- Stress** – The sum of biological reactions to any adverse stimuli (physical, internal or external) that disturb the organism's optimum operating status and may reduce its chances of survival.
- Sustainable development** – Management and conservation of the natural resource base, and the orientation of technological and institutional change in such a manner as to ensure the attainment of continued satisfaction of human needs for present and future generations. Such sustainable development conserves land, water, plants and animal genetic resources, is environmentally non-degrading, technologically appropriate, economically viable and socially acceptable.

System cycling – Initial development of a biofilter within an aquaculture or aquarium system as the tank and biofilter material are colonized by ammonia-oxidizing bacteria and nitrite-oxidizing bacteria. These groups of bacteria oxidize the original source of ammonia into nitrite and nitrate, respectively. It usually takes between one and six weeks depending on temperature, water quality and ammonia source. Adequate system cycling reduces the effects of new tank syndrome.

Turnover rate – In culture systems such as tanks, raceways, ponds and other units, this term refers to the real water exchange rate over a period of time defined as the inverse of residence time: Q (water quantity, in m^3/h) / V (unit volume, in m^3).

Ultraviolet – Non-visible electromagnetic waves, which follow at the end of the violet end of the light spectrum. That part of the solar radiation spectrum between 40 nm and 400 nm wavelength. Used in aquaculture to disinfect water and prevent diseases caused by pathogenic microorganisms.

Appendixes

Appendix 1 – Vegetable production guidelines for 12 common aquaponic plants	169
Appendix 2 – Plant pests and disease control	183
Appendix 3 – Fish pests and disease control	187
Appendix 4 – Calculating the amount of ammonia and biofilter media for an aquaponic unit	191
Appendix 5 – Making homemade fish feed	193
Appendix 6 – Key considerations before setting up an aquaponic system	199
Appendix 7 – Cost-benefit analysis for small-scale aquaponic units	205
Appendix 8 – Step-by-step guide to constructing small-scale aquaponic systems	209

Appendix 1 – Vegetable production guidelines for 12 common aquaponic plants

The information below provides technical advice on 12 of the most popular vegetables to grow in aquaponics. Information on optimal growing conditions, including specific growing instructions and harvesting techniques for each vegetable, is included. The guidelines below are based on the experience gathered from long-standing aquaponic farming, from horticulture manuals on soil/soil-less cropping, extension papers, and the professional experience of farmers and researchers. This list is by no means exhaustive. Rather, it should be used as an example of the types of information needed for any crop grown and help readers target their research when growing crops that are not listed here. Other common crops, not included in this appendix are: okra, pak choy, bok choy, ong choy, tatsoi, kale, mint, thyme, dill, scallions, chives, cilantro, taro, watercress, salad rocket, edible flowers, ornamental flowers, and even small fruit trees. Root vegetables such as onion, carrot, beets, radish and taro should be grown in wicking beds attached to media beds.

BASIL

pH: 5.5–6.5

Plant spacing: 15–25 cm (8–40 plants/m²)

Germination time and temperature: 6–7 days with temperatures at 20–25 °C

Growth time: 5–6 weeks (start harvesting when plant is 15 cm)

Temperature: 18–30 °C, optimal 20–25 °C

Light exposure: Sunny or slightly sheltered

Plant height and width: 30–70 cm; 30 cm

Recommended aquaponic method: media beds, NFT and DWC



Growing basil in aquaponic units: Basil is one of the most popular herbs to grow in aquaponic units, particularly in large-scale commercial monoculture units because of its high value and the high demand in urban or peri-urban zones. Many cultivars of basil have been tried and tested in aquaponic units including the Italian Genovese basil (sweet basil), lemon basil, and purple passion basil. Owing to the higher nitrogen

uptake, basil is an ideal plant for aquaponics; however, care should be used to avoid excessive nutrient depletion of the water.

Growing conditions: Basil seeds need a reasonably high and stable temperature to initiate germination (20–25 °C). Once transplanted in the units, basil grows best in warm to very warm conditions and full exposure to sun. However, better quality leaves are obtained through slight shading. With daily temperatures higher than 27 °C plants should be ventilated or covered with shading nets (20 percent) during strong solar radiation seasons to prevent tip burn.

Growing instructions: Transplant new seedlings into the aquaponic unit when the seedlings have 4–5 true leaves. Basil can be affected by various fungal diseases, including *Fusarium* wilt, grey mould, and black spot, particularly under suboptimal temperatures and high humidity conditions. Air ventilation and water temperatures higher than 21 °C, day and night, help to reduce plant stress and incidence of diseases.

Harvesting: The harvest of leaves starts when plants reach 15 cm in height and continues for 30–50 days. Care should be used when handling leaves at harvest to avoid leaf bruising and blackening. It is advisable to remove flowering tips during plant growth to avoid bitter tastes in leaves and encourage branching. However, basil flowers are attractive to pollinators and beneficial insects, so leaving a few flowering plants can improve the overall garden and ensure a constant supply of basil seeds. Basil seeds are a speciality product in some locations.

CAULIFLOWER

pH: 6.0–6.5

Plant spacing: 45–60 cm (3–5 plants/m²)

Germination time and temperature: 4–7 days with temperature 8–20 °C

Growth time: 2–3 months (spring crops), 3–4 months (autumn crops)

Temperature: 20–25 °C for initial vegetative growth, 10–15 °C for head setting (autumn crop)

Light exposure: full sun

Plant height and width: 40–60 cm; 60–70 cm

Recommended aquaponic method: media beds



Growing cauliflower in aquaponic units: Cauliflower is a high-value, nutritious winter crop that will grow and thrive in media bed units with adequate plant spacing. Cauliflower has a relatively high nutrient demand, and the plants react positively to high concentrations of nitrogen and phosphorus. Among other nutrients, potassium

and calcium are important for the production of heads. The plant is particularly sensitive to climatic conditions, and the heads do not develop properly in hot, very cold or very dry conditions; therefore, selecting the suitable variety and the timing to transplant are crucial.

Growing conditions: Optimal air temperature for the initial vegetative growth of the plant is 15–25 °C. For the formation of the heads, the plants require colder temperatures of 10–15 °C (autumn crop) or 15–20 °C (spring crop) providing that a good percentage of relative humidity and full sun conditions are met to develop good heads. Plants can tolerate cold temperatures; however, heads can be damaged by frost. Light shade can be beneficial in warmer temperatures (above 23 °C).

Growing instructions: Germinate seeds in propagation trays at 20–25 °C. Provide direct sun from early seedling stages so plants do not become leggy. When plants are 3–5 weeks old and have 4–5 true leaves, begin transplanting into the aquaponic system about 50 cm apart. To preserve the white colour of the heads, use string or rubber bands to secure outside leaves over the head when it is about 6–10 cm in diameter. Once this stage is reached, harvest may take less than a week in ideal temperatures or as long as a month in cooler conditions. Too much sun, heat or nitrogen uptake can cause “ricey” heads where the main flower separates into small, rice-like grains. Temperatures below 12 °C could instead produce “buttoning”. Cauliflower is susceptible to some pests including cabbageworms, flea beetle, white maggots (larvae) and cabbage aphids, which can be removed manually or by using other pest management techniques.

Harvesting: Harvest when the heads are compact, white and firm. Cut the heads off the plant with a large knife, and remove the remaining plant and roots from the bed pipe and place into a compost bin.

LETTUCE (MIXED SALAD LEAVES):

pH: 6.0–7.0

Plant spacing: 18–30 cm (20–25 heads/m²)

Germination time and temperature: 3–7 days; 13–21 °C

Growth time: 24–32 days (longer for some varieties)

Temperature: 15–22 °C (flowering over 24 °C)

Light exposure: full sun (light shading in warm temperatures)

Plant height and width: 20–30 cm; 25–35 cm

Recommended aquaponic method: media bed, NFT and DWC



Growing lettuce in aquaponic units: Lettuce grows particularly well in aquaponics owing to the optimal nutrient concentrations in the water. Many varieties can be grown in aquaponics, but four main types are included here: crisphead lettuce (iceberg), which has tight head with crispy leaves, ideal for cooler conditions; butterhead lettuce, which show leaves that are loosely piled one on another and have no bitter taste; Romaine lettuce, which has upright and tightly folded leaves that are slow to bolt and are sweet in taste; and loose leaf lettuce, which comes out in a variety of colours and shapes with no head and can be directly sowed on media beds and harvested by picking single leaves without collecting the whole plant. Lettuce is in high demand and has a high value in urban and peri-urban zones, which makes it a very suitable crop for large-scale commercial production.

Growing conditions: Lettuce is a winter crop. For head growth, the night air temperature should be 3–12 °C, with a day temperature of 17–28 °C. The generative growth is affected by photoperiod and temperature – extended daylight and warm conditions (> 18 °C) at night cause bolting. Water temperature > 26 °C may also favour bolting and leaf bitterness. The plant has low nutrient demand; however, higher calcium concentrations in water help to prevent tip burn in leaf in summer crops. The ideal pH is 5.8–6.2, but lettuce still grows well with a pH as high as 7, although some iron deficiencies might appear owing to reduced bio-availability of this nutrient above neutrality.

Growing instructions: Seedlings can be transplanted in aquaponic units at three weeks when plants have at least 2–3 true leaves. Supplemental fertilization with phosphorus to the seedlings in the second and third weeks favours root growth and avoids plant stress at transplant. Moreover, plant hardening, through exposing of seedlings to colder temperatures and direct sunlight, for 3–5 days before transplanting results in higher survival rates. When transplanting lettuce in warm weather, place light sunshade over the plants for 2–3 days to avoid water stress. To achieve crisp, sweet lettuce, grow plants at a fast pace by maintaining high nitrate levels in the unit. When air and water temperatures increase during the season, use bolt-resistant (summer) varieties. If growing in media beds, plant new lettuces where they will be partially shaded by taller nearby plants.

Harvesting: Harvesting can begin as soon as heads or leaves are large enough to eat. If selling to markets, remove the full plants and roots when harvesting as soon as they reach market weight (250–400 g). Cut the roots out and place them in a compost bin. Harvest early in the morning when leaves are crisp and full of moisture and chill quickly.

CUCUMBERS

pH: 5.5–6.5

Plant spacing: 30–60 cm (depending on variety; 2–5 plants/m²)

Germination time and temperature: 3–7 days; 20–30 °C

Growth time: 55–65 days

Temperature: 22–28 °C day, 18–20 °C night; highly susceptible to frost.

Light exposure: full sun

Plant height and width: 20–200 cm; 20–80 cm

Recommended aquaponic method: media beds; DWC



Growing cucumbers in aquaponic units: Cucumbers, along with other members of the Cucurbitaceae family including squash, zucchini and melons, are excellent high-value summer vegetables. They are ideal plants to grow in media bed units as they have a large root structure. Cucumbers can also be grown on floating rafts, although in grow pipes there could be the risk of clogging owing to excessive root growth. Cucumbers require large quantities of nitrogen and potassium, thus the choice for the number of plants should take into account the nutrients available in the water and the fish stocking biomass.

Growing conditions: Cucumbers grow best with long hot humid days with ample sunshine and warm nights. Optimal growth temperatures are 24–27 °C during the day with 70–90 percent of relative humidity. A temperature of the substrate of about 21 °C is also optimal for production. Plants stop their growth and production at 10–13 °C. It is recommended to have higher potassium concentration to favour higher fruit settings and yields.

Growing instructions: Cucumbers seedlings can be transplanted at 2–3 weeks at the 4–5 leaf stage. Plants grow very quickly and it is a good practice to limit their vegetative vigour and divert nutrients to fruits by cutting their apical tips when the stem is two metres long; removing the lateral branches also favours ventilation. Further plant elongation can be successively secured by leaving only the two farthest buds coming out from the main stem. Plants are encouraged to further production by regular harvesting of fruits of marketable size (> 180 g for slicing varieties). The presence of pollinating insects is necessary for good fecundation and fruit set. Cucumber plants need support for their growth, which will also provide plants with adequate aeration to prevent foliar diseases (powdery mildew, grey mould). Owing to the high incidence of pest occurrences in cucumber plants, it is important to plan appropriate integrated pest management strategies (see Chapter 6) and to intercrop the plant unit with plants that are less affected by the possible treatments used.

Harvesting: Once transplanted, cucumbers can start production after 2–3 weeks. In optimal conditions, plants can be harvested 10–15 times. Harvest every few days to prevent the fruits from becoming overly large and to favour the growth of the following ones.

EGGPLANT**pH:** 5.5–7.0**Plant spacing:** 40–60 cm (3–5 plants/m²)**Germination time and temperature:** 8–10 days; 25–30 °C**Growth time:** 90–120 days**Temperature:** 15–18 °C night, 22–26 °C day; highly susceptible to frost**Light exposure:** full sun**Plant height and width:** 60–120 cm; 60–80 cm**Recommended aquaponic method:** media beds

Growing eggplant in aquaponic units: Eggplant is a summer fruiting vegetable that grows well in media beds owing to the deep growth of the root systems. Plants can produce 10–15 fruits for a total yield of 3–7 kg. Eggplants have high nitrogen and potassium requirements, which indicates the need for careful management choices in the number of plants to grow in each aquaponic unit in order to avoid nutrient imbalances.

Growing conditions: Eggplants enjoy warm temperatures with full sun exposure. Plants perform best with daily temperatures in the range of 22–26 °C and relative humidity of 60–70 percent, both of which favour strong fruit set. Temperatures < 9–10 °C and > 30–32 °C are very limiting.

Growing instructions: Seeds germinate in 8–10 days in warm temperatures (26–30 °C). Seedlings can be transplanted at 4–5 leaves. Plants can be transplanted when temperatures rise in spring. Towards the end of the summer season, begin pinching off new blossoms to favour the ripening of the existing fruit. At the end of the season, plants can be drastically pruned at 20–30 cm by leaving just three branches. This method interrupts the crop without removing the plants during the unfavourable season (winter, summer) and lets the crop restart the production afterwards. Plants can be grown without pruning; however, in limited spaces or in greenhouses, management of the branches can be facilitated with stakes or vertical strings.

Harvesting: Start harvesting when the eggplants are 10–15 cm long. The skin should be shiny; dull and yellow skin is a sign that the eggplant is overripe. Delayed harvest makes the fruits unmarketable owing to the presence of seeds inside. Use a sharp knife and cut the eggplant from the plant, leaving at least 3 cm of the stem attached to the fruit.

PEPPERS

pH: 5.5–6.5

Plant spacing: 30–60 cm (3–4 plants/m², or more for small-sized plant varieties)

Germination time and temperature: 8–12 days; 22–30 °C (seeds will not germinate below 13 °C)

Growth time: 60–95 days

Temperature: 14–16 °C night time, 22–30 °C daytime

Light exposure: full sun

Plant height and width: 30–90 cm; 30–80 cm

Recommended aquaponics method: media beds

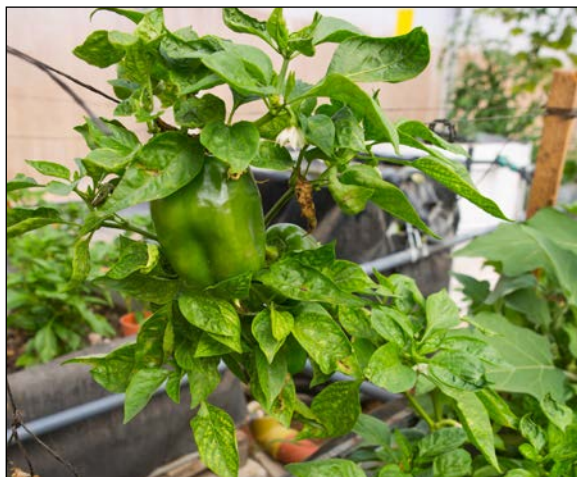

Growing peppers in aquaponic units: There are many varieties of peppers, all varying in colour and degree of spice, yet from the sweet bell pepper to the hot chili peppers (jalapeño or cayenne peppers) they can all be grown with aquaponics. Peppers are more suited to the media bed method but they might also grow in 11 cm diameter NFT pipes if given extra physical support.

Growing conditions: Peppers are a summer fruiting vegetable that prefers warm conditions and full sun exposure. Seed germination temperatures are high: 22–34 °C. Seeds will not germinate well in temperatures < 15 °C. Daytime temperatures of 22–28 °C and night-time temperatures of 14–16 °C favour best fruiting conditions under a relative humidity of 65–60 percent. Optimal temperatures at root level are 15–20 °C. In general, air temperatures below 10–12 °C stop plant growth and cause abnormal deformation of the fruits, making them unmarketable. Temperatures > 30–35 °C lead to floral abortion or fallout. In general, spicier peppers can be obtained at higher temperatures. The top leaves of the plant protect the fruit hanging below from sun exposure. As with other fruiting plants, nitrate supports the initial vegetative growth (optimum range: 20–120 mg/litre) but higher concentrations of potassium and phosphorus are needed for flowering and fruiting.

Growing instructions: Transplant seedlings with 6–8 true leaves to the unit as soon as night temperatures settle above 10 °C. Support bushy, heavy-yielding plants with stakes or vertical strings hanging from iron wires pulled horizontally above the units. For red sweet peppers, leave the green fruits on the plants until they ripen and turn red. Pick the first few flowers that appear on the plant in order to encourage further plant growth. Reduce the number of flowers in the event of excessive fruit setting to favour the growing fruits to reach adequate size.

Harvesting: Begin harvesting when peppers reach a marketable size. Leave peppers on the plants until they ripen fully by changing colour and improve their levels of vitamin C. Harvest continually through the season to favour blossoming, fruit setting and growth. Peppers can be easily stored fresh for 10 days at 10 °C with 90–95 percent humidity, or they can be dehydrated for long-term storage.

TOMATO

pH: 5.5–6.5

Plant spacing: 40–60 cm (3–5 plants/m²)

Germination time and temperature: 4–6 days; 20–30 °C

Growth time: 50–70 days till first harvest; fruiting 90–120 days up to 8–10 months (indeterminate varieties)

Optimal temperatures: 13–16 °C night, 22–26 °C day

Light exposure: full sun

Plant height and width: 60–180 cm; 60–80 cm

Recommended aquaponic method: media beds and DWC



Growing tomatoes in aquaponic units: Tomatoes are an excellent summer fruiting vegetable to grow using all methods of aquaponics, although physical support is necessary. Given the high nutrient demand of tomatoes, especially potassium, the number of plants per unit should be planned according to the fish biomass, in order to avoid nutrient deficiencies. A higher nitrogen concentration is preferable during early stages to favour plants' vegetative growth; however, potassium should be present from the flowering stage to favour fruit settings and growth.

Growing conditions: Tomatoes prefer warm temperatures with full sun exposure. Below 8–10 °C the plants stop growing, and night temperatures of 13–14 °C encourage fruit set. Temperatures above 40 °C cause floral abortion and poor fruit setting. There are two major types of tomato plants: determinate (seasonal production) and indeterminate (continuous production of floral branches). In the first type, plants can be left to grow as bushes by leaving 3–4 main branches and removing all the auxiliary suckers to divert nutrients to fruits. Both determinate and indeterminate varieties should be grown with a single stem (double in case of high plant vigour) by removing all the auxiliary suckers. However, in determinate varieties, the apical tip of the single stem has to be cut as soon as the plant reaches 7–8 floral branches in order to favour fruiting. Tomatoes rely on supports that can be either made of stakes (bush plants) or bound to vertical plastic/nylon strings that are attached to iron wires pulled horizontally above the plant units.

Tomatoes have a moderate tolerance to salinity, which makes them suitable for areas where pure freshwater is not available. Higher salinity at fruiting stage improves quality of the products.

Planting instructions: Set stakes or plant support structures before transplanting to prevent root damage. Transplant the seedlings into units 3–6 weeks after germination when the seedling is 10–15 cm and when night-time temperatures are constantly above 10 °C. In transplanting the seedlings, avoid waterlogged conditions around the plant collar to reduce any risks of diseases. Once the tomato plants are about 60 cm tall, start to determine the growing method (bush or single stem) by pruning the unnecessary upper branches. Remove the leaves from the bottom 30 cm of the main stem to favour a better air circulation and reduce fungal incidence. Prune all the auxiliary suckers to favour fruit growth. Remove the leaves covering each fruit branch soon before ripening to favour nutrition flow to the fruits and to accelerate maturation.

Harvesting: For best flavour, harvest tomatoes when they are firm and fully coloured. Fruits will continue to ripen if picked half ripe and brought indoors. Fruits can be easily maintained for 2–4 weeks at 5–7 °C under 85–90 percent relative humidity.

BEANS AND PEAS

pH: 5.5–7.0

Plant spacing: 10–30 cm dependent on variety (bush varieties 20–40 plants/m², climbing varieties 10–12 plants/m²)

Germination time and temperature: 8–10 days; 21–26 °C

Growth time: 50–110 days to reach maturity depending on variety

Temperature: 16–18 °C night, 22–26 °C day

Light exposure: full sun

Plant height and width: 60–250 cm (climbing); 60–80 cm (bush)

Recommended aquaponic method: media bed

Growing beans in aquaponic units: Both climbing and bush bean varieties grow well in aquaponic units, but the former are recommended for less use of space, which maximizes aquaponic bed use. Climbing varieties can also yield 2–3 times more pods than bush varieties. Beans have low nitrate needs, but have a moderate demand in terms of phosphorus and potassium. Such nutrient requirements make beans an ideal choice for aquaponic production, although excess nitrate may delay flowering. Beans are recommended for newly established units as they may fix atmospheric nitrogen on their own.



Growing conditions for pole beans: Climbing varieties enjoy full sun, but will tolerate partial shade in warm conditions. Plants do not grow at < 12–14 °C. Temperatures > 35 °C cause floral abortion and poor fruit set. Optimal relative humidity for plants is 70–80 percent. Beans are sensitive to the photoperiod; thus, it is important to choose the right varieties according to the location and season. In general, climbing varieties are cultivated in summer while dwarf varieties are adapted to short-day conditions (spring or autumn).

Growing instructions for pole beans: For media bed units, seed directly into the grow bed 3–4 cm deep (making sure the bell siphon is out so the water level is high during germination). Beans do not transplant well, which makes them hard to grow in NFT pipes. Any supporting pole should be placed before seed germination in order to avoid root damage. In sowing, care should be taken to avoid future cross-shading with other plants. Beans are susceptible to aphids and spider mites. Although low occurrences of such pests could be controlled with mechanical remedies, attention should be paid to the choice of companion plants to avoid cross-contamination if any treatment has to be carried out.

Harvesting:

Snap bean varieties (green or yellow wax beans) - Pods should be firm and crisp at harvest; the seeds inside should be undeveloped or small. Hold stem with one hand and pod with the other to avoid pulling off branches that will produce later pickings. Pick all pods to keep plants productive.

Shell beans (black, broad or fava beans) - Pick these varieties when the pods change colour and the beans inside are fully formed but not dried out. Pods should be plump, firm. Quality declines if they are left on the plant for too long.

Dried beans (kidney beans and soybeans) - Let the pods become as dry as possible before cooler weather sets in or when plants have turned brown and lost most of their leaves. Pods will easily split when very dry, making seed removal an easy process.

HEAD CABBAGE

pH: 6–7.2

Plant spacing: 60–80 cm (4–8 plants/m²)

Germination time and temperature: 4–7 days; 8–29 °C

Growth time: 45–70 days from transplanting (depending on varieties and season)

Ideal temperature: 15–20 °C (growth stops at > 25 °C)

Light exposure: full sun

Plant height and width: 30–60 cm; 30–60 cm

Recommended aquaponic method: media beds (not suitable for newly established aquaponic units)



Growing cabbage in aquaponic units: Cabbage is a highly nutritious winter crop. The plants grow best in media beds because they reach significant dimensions at harvest and may be too large and heavy for rafts or grow pipes. Cabbage is a nutrient-demanding plant, which makes it unsuitable for newly established units (less than four months old). Nevertheless, owing to the large space required, cabbage crops take up fewer

nutrients per square metre than other winter leafy vegetables (lettuce, spinach, rocket, etc.). Although cabbage can tolerate temperatures as low as 5 °C, the low temperatures may not be suitable for culturing fish.

Growing conditions: Cabbage is a winter crop with ideal growing temperatures of 15–20 °C; Cabbage grows best when the heads mature in cooler temperatures, so plan to harvest before daytime temperatures reach 23–25 °C. High concentrations of phosphorus and potassium are essential when the heads begin to grow. Integration with organic fertilizers delivered either on leaves or substrates may be necessary in order to supply plants with adequate levels of nutrients.

Growing instructions: Transplant seedlings at 4–6 leaves and a height of 15 cm. Position seedlings with an optimal planting density according to the chosen variety. In the event of day temperatures > 25 °C, use a shading net of 20 percent light shading to prevent the plant from bolting (growing to produce seeds). Given the high incidence of cabbage worms and other pests such as aphids, root maggots and cabbage loopers, it is important to carry out careful monitoring and use organic (aquaponic safe) pesticides when necessary.

Harvesting: Start harvesting when cabbage heads are firm with a diameter of about 10–15 cm (depending on variety grown). Cut the head from the stem with a sharp knife, and place the outer leaves into the compost bin. If cabbage heads tend to break, it indicates they are over-ripe and should have been harvested earlier.

BROCCOLI

pH: 6–7

Plant spacing: 40–70 cm (3–5 plants/m²)

Germination time and temperature: 4–6 days; 25 °C

Growth time: 60–100 days from transplant

Average daily temperature: 13–18 °C

Light exposure: full sun; can tolerate partial shade but will mature slowly

Plant height and width: 30–60 cm; 30–60 cm

Recommended aquaponic method: media beds



Growing broccoli in aquaponic units: Broccoli is a nutritious winter vegetable. The media bed method is the recommended option as broccoli is a large and heavy plant at harvest. Broccoli is moderately difficult to grow because it is a nutrient-demanding plant. It is also highly susceptible to warm temperatures; therefore, select a variety that is bolt-resistant.

Growing conditions: Broccoli grows best when daytime temperatures are 14–17 °C. For head formation, winter varieties require temperatures of 10–15 °C. Higher temperatures are possible, providing that a higher humidity is present. Hot temperatures cause premature bolting.

Growing instructions: Transplant seedlings into media beds once 4–5 true leaves are present and the plants are 15–20 cm high. Seedlings should be positioned 40–50 cm apart as closer spacing will produce smaller central heads. Broccoli, as well as cabbage, is susceptible to cabbage worms and other persistent pests. While some mechanical removal can have marginal effect, treatment with biological pesticides and repellents can control the infestations.

Harvesting: For best quality, begin harvesting broccoli when the buds of the head are firm and tight. Harvest immediately if the buds start to separate and begin flowering (yellow flowers).

SWISS CHARD / MANGOLD

pH: 6–7.5

Plant spacing: 30–30 cm (15–20 plants/m²)

Germination time and temperature: 4–5 days; 25–30 °C optimal

Growth time: 25–35 days

Temperature: 16–24 °C

Light exposure: full sun (partial shade for temperatures > 26 °C)

Plant height and width: 30–60 cm; 30–40 cm

Recommended aquaponic method: media beds, NFT pipes and DWC



Growing Swiss chard in aquaponic units: Swiss chard is an extremely popular leafy green vegetable to grow using aquaponics and it thrives with all three aquaponic methods. It is a moderate nitrate feeder and requires lower concentrations of potassium and phosphorus than fruiting vegetables, which makes it an ideal plant for aquaponics. Owing to its high market value, its fast growth rate and its nutritional content, Swiss chard is frequently grown in commercial aquaponic systems. Foliage is green to dark green, but the stems can have striking and attractive colours of yellow, purple or red.

Growing conditions: Swiss chard optimal temperatures are 16–24 °C, while the minimum temperature for growth is 5 °C. Although traditionally a late-winter/spring crop (tolerating moderate frosts), Swiss chard may also grow well in full sun during mild summer seasons. A shading net is suggested at higher temperatures. Swiss chard has a moderate tolerance to salinity, which makes it an ideal plant for saline water.

Growing instructions: Swiss chard seeds produce more than one seedling; therefore, thinning is required as the seedlings begin to grow. As plants become senescent during the season, older leaves can be removed to encourage new growth.

Harvesting: Swiss chard leaves can be continuously cut whenever they reach harvestable sizes. The removal of larger leaves favours the growth of new ones. Avoid damaging the growing point in the centre of the plant at harvest.

PARSLEY

pH: 6–7

Plant spacing: 15–30 cm (10–15 plants/m²)

Germination time and temperature: 8–10 days; 20–25 °C

Growth time: 20–30 days after transplant

Temperature: 15–25 °C

Light exposure: full sun; partial shade at > 25 °C

Plant height and width: 30–60 cm; 30–40 cm

Recommended aquaponic method: media beds, NFT and DWC

Growing parsley in aquaponic units: Parsley is a very common herb grown in both domestic and commercial aquaponic units owing to its nutritional content (rich in vitamins A and C, calcium and iron) and its high market value. Parsley is an easy herb to grow as the nutrient requirements are relatively low compared with other vegetables.

Growing conditions: Parsley is a biennial herb but it is traditionally grown as an annual; most varieties will grow over a two-year period if the winter season is mild with minimal to moderate frost. Although the plant can resist temperatures of 0 °C, the minimum temperature for growth is 8 °C. In the first year, the plants produce leaves while in the second the plants will begin sending up flower stalks for seed production. Parsley enjoys full sun for up to eight hours a day. Partial shading is required for temperatures > 25 °C.



Growing instructions: The main difficulty when growing parsley is the initial germination, which can take 2–5 weeks, depending on how fresh the seeds are. To accelerate germination, seeds can be soaked in warm water (20–23 °C) for 24–48 hours to soften the seed husks. Afterwards, drain the water and sow the seeds into propagations trays. Emerging seedlings will have the appearance of grass, with two narrow seed leaves opposite each other. After 5–6 weeks, transplant the seedlings into the aquaponic unit during early spring.

Harvesting: Harvesting begins once the individual stalks of the plant are at least 15 cm long. Harvest the outer stems from the plant first as this will encourage growth throughout the season. If only the top leaves are cut, the stalks will remain and the plant will be less productive. Parsley dries and freezes well. If dried, plants can be crushed by hand and stored in an airtight container.

Appendix 2 – Plant pests and disease control

Aquaponic pest management can benefit from most of the common biological methods used in organic agriculture. However, it is important to remember that a strategy against pests should be planned according to the insects occurring in that particular area and the crop being cultivated during a specific season and a given environment.

PEST CONTROL: REPELLENTS, SOFT-CHEMICALS AND PLANT-DERIVED INSECTICIDES

Soft-chemical alternatives to industrial pesticides can also be applied to deter pests. Organic mixes consisting of crushed garlic, pepper, soap and insecticidal oils can all be used to remove the threat of pests. If using soaps, make sure to use natural soaps, otherwise potentially harmful chemicals typically found in synthetic soaps can make their way into the water. Soaps can damage fish gills, so care should be used not allow too much to enter the water. Thorough coverage of the plant is necessary for effective pest control. Although observed and empirical knowledge on many of these methods suggests they work, there has not been systematic scientific research on their efficacy. Moreover, the medicinal properties of vegetables extracts used would suggest caution in their use because of toxicity risks to the fish.

Product	Function/action	Pest controlled	Method of application
Citrus/citronella	Repellent.	Broad spectrum of pests.	Dissolve the product in water and spray on plants thoroughly.
Garlic oil	Insecticidal properties which are enhanced if mixed with oil and soap.	Aphids, cabbage worms, leafhoppers, whiteflies, some beetles and nematodes.	Dissolve 85 g of minced garlic in 15 ml of vegetable oil and steep for 24 hrs. After, add the mix to 500 ml of water and spray on plants thoroughly.
Hot peppers, paprika (capsaicin dust)	Pest repellent.	Maggot, ants.	Sprinkle the dust over the plants.
Tomato leaf spray	Attractant of beneficial microbes, possible toxic effect for alkaloids.	Aphids, corn earworm.	Take 250 ml of fresh tomato leaves and place into 250 ml of water for 12 hrs. Strain and further dilute using another cup of water. Spray on target plants thoroughly.
Essential oils (sage, thyme)	Pest repellent. Reduces the level of feeding damage.	Broad range of pests.	Mix a few drops in 250 ml of water and spray on target plants.
Alcohol extract (rosemary, hyssop, sage, thyme, etc.)	Repellent. Reduces the level of feeding damage.	Broad range of pests.	Soak 250 ml of fresh leaves in 400 ml of water overnight. Strain out the leaves and use as foliar spray.
Soaps (salt of fatty acids)	Penetrates the cuticles causing dehydration and eventual death.	Soft-bodied insects: aphids, mealy bugs, whiteflies. Also mites, scales, thrips, ticks.	Use natural soaps: 1 (or more) tablespoon per 4 litres of water (adjustable depending on the plants and pests). Soaps can also be mixed with vegetable oils (see below).
Vegetable oils	Suffocates pests.	Aphids, mealybugs, mites, scales.	Spray on a 2 % concentration during the mornings or evenings. Commercial products should also be sold with an emulsifying agent.
Lime/ash	Repellent.	Broad range of pests.	Finely sieve the ash and blow on wet leaves using a duster.
Starch spray (wheat flour or potato dextrin)	Trapping agent at the leaf surface.	Aphids, spiders, mites, thrips, whiteflies.	Mix 30–45 ml of potato starch in 1 litre of water along with 2–3 drops of liquid soap. Use as foliar spray.

Source: Ellis and Bradley (1996) – See Further Reading section for full reference.

PEST CONTROL: INSECTICIDES, PLANT-DERIVED

Biological insecticides deserve particular attention in aquaponics as not all of them are suitable for fish. Although biological insecticides are classified for organic use, most of them are **toxic to fish** and to beneficial insects. The table below listed a number of common insecticides and critical information for their safe use.

Botanical insecticides	Origin	Effect on pests	Conditions for use
Nicotine (aqueous extract of tobacco)	Plant	Neurotoxic insecticide.	Toxic to fish.
Neem (<i>Azadirachta indica</i>)	Plant	Potent antifeedant. Needs repeated treatments, every 10 days.	Toxic to fish, may be used as foliar spray away from water. Does not harm beneficial insects. Also fungicide.
Pyrethrum (<i>Chrysanthemum cinerariaefolium</i>)	Plant	Natural neurotoxic insecticide. Broad spectrum insecticide, also kills beneficial microorganisms.	Toxic to fish, may be used as foliar spray away from water. Low persistence, easily destroyed with light in 1–3 days.
Rotenone (<i>Derris elliptica</i> , <i>Lonchocarpus</i> spp., <i>Tephrosia</i> spp.)	Plant	Natural insecticide effecting a broad spectrum of pests.	Extremely toxic to fish, may be used as foliar spray away from water. Suitable for plant nurseries before transplant to aquaponic unit.
Quassia (<i>Quassia amara</i>)	Plant	Causes phagodeterrence in insect larvae.	Wood extract spray. Non-toxic to fish.
Ryania (<i>Ryania speciosa</i>)	Plant	Calcium channel disruptor for cells of pests.	Use sparingly and with caution as moderately toxic to fish.
Sabadilla	Plant	Interferes with nerve membrane of pests.	Use with caution, toxic effects still not well known for fish.
Diatomaceous earth (DE)	Inorganic	Abrasive dust absorbs lipids from the waxy outer layer of insects' skeletons (i.e. ants), causing them to dehydrate.	Wear a mask when applying to avoid dust inhalation. Non-toxic to fish.
Sulphur (powdered or lime sulphur)	Inorganic	Pest repellent and effective insecticide against mites.	Can also be used as fungicide.
Copper	Inorganic	In the form of Bordeaux mix as an insect repellent.	Copper is also a fungicide, but avoid over-accumulation in water – toxic to crustaceans.

Source: Copping, 2004; Shour, 2000; Soil Association, 2011; IFOAM, 2012 – See Further Reading section for full reference.

PEST CONTROL: BENEFICIAL INSECTS

Beneficial insects can be used to control pests. This method is more applicable for large producers, as the cost can be prohibitive on a small-scale. The choice of insect must be matched to the pest insect and environmental conditions.

Beneficial insect/organism	Type	Pest to control
<i>Adalia bipunctuata</i>	Predatory beetle	Aphids
<i>Aphelinus abdominalis</i>	Parasitoid	Aphids
<i>Chrysoperla carnea</i>	Lacewings	Aphids
<i>Aphidius colemani</i>	Predatory wasp	Aphids
<i>Cryptolaemus montrouzieri</i>	Predatory beetle	Mealybug
<i>Coccidoxenoides perminutus</i>	Parasitoid wasp	Mealybug
<i>Trichogramma</i> spp.	Parasitoid	Caterpillars
<i>Heterorhabditis megidis</i>	Nematode	Chafer grub larvae
<i>Steinernema carpocapsae</i>	Nematodes	Codling Moths
<i>Cydia pomonella</i>	Granular virus	Codling Moth
<i>Anagrus atomus</i>	Parasitic wasp	Leafhoppers
<i>Dacnusa sibirica</i> and <i>Diglyphus</i>	Parasitoid	Leaf miners
<i>Chilocorus nigritus</i>	Predatory beetle	Scale insects
<i>Hypoaspis miles</i>	Predatory mite	Sciarid fly and thrips

TABLE CONTINUED

Beneficial insect/organism	Type	Pest to control
<i>Steinernema feltiae</i>	Nematode	Sciarid flies and thrips
<i>Amblyseius cucumeris</i>	Predatory mite	Thrips
<i>Phytoseiulus persimilis</i>	Predatory mite	Thrips
<i>Orius insidiosus</i>	Predatory bug	Thrips
<i>Amblyseius californicus</i>	Predatory mite	Spider mites
<i>Feltiella acarisuga</i>	Mite midge	Spider mites
<i>Encarsia formosa</i>	Parasitoid	Greenhouse whitefly
<i>Eretmocerus eremicus</i>	Parasitoid	Greenhouse whitefly
<i>Eretmocerus eremicus</i>	Parasitoid	Whitefly
<i>Heterorhabditis megidis</i>	Nematode	Vine weevil
<i>Phasmarhabditis hermaphrodita</i>	Nematode	Slugs

Source: Olkowski et al., 2003; Soil Association, 2011 – See Further Reading section for full reference.

DISEASE CONTROL: ENVIRONMENTAL

Many fungal diseases are dependent of temperature and humidity, and as such, controlling the environmental factors can mitigate the disease. If the environmental factors cannot be controlled, it may be better to choose resistant crops or varieties.

Disease	Disease agent	Plants	Target	Temp. (°C)	Humidity
Root rot	<i>Pythium</i> spp.	Lettuce	Roots	28–30	Waterlogged soil
Downy mildew	<i>Pseudoperonospora cubensis</i>	Cucumber, zucchini, squash	Leaves	20–25	Leaf wetness for 1 hour
Powdery mildew	<i>Sphaerotheca fuliginea</i>	Cucumber, zucchini, squash	Leaves	27	–
<i>Verticillium</i> wilt	<i>Verticillium</i> spp.	Various	Stems	21–27	Moist soil
<i>Fusarium</i> wilt	<i>Fusarium oxysporum</i>	Cucumber, squash zucchini	Stems	25–27	–
Early blight	<i>Alternaria solani</i>	Tomato, potato	Leaves	28–30	Free moisture

DISEASE CONTROL: INORGANIC CHEMICAL

Some inorganic compounds can be used to treat fungal diseases, and many of these are acceptable to use in aquaponic units. The table below outlines a few of these options.

Substance	Condition of use
Clays	Foliar application.
Copper salts	Foliar application. Use with caution as copper can accumulate in the system. It is preferable to use at seedling stage before transplanting.
Sulphur	Foliar application. Use with caution, as it may accumulate in the system (negatively affects plant growth).
Lime sulphur (calcium polysulphide)	Foliar application as a fungicide only. Use with caution, as it may accumulate in the system (negatively affects plant growth).
Potassium bicarbonate	Foliar application. This can be also used to increase carbonate hardness (KH) which buffers the pH of the aquaponic water (see Chapter 3).
Sodium bicarbonate	Foliar application, do not use to buffer the water pH as sodium accumulates in the system and negatively affects plant growth.
Calcium hydroxide (hydrated lime)	Foliar application as a fungicide only.
Silicates/silicon	Foliar application.

Source: Modified from IFOAM, 2012 – See Further Reading section for full reference.

COMPANION PLANTING CHART

Companion planting is a small-scale intercropping method that is very common in organic and biodynamic horticulture. The justifying theory is that the association of different plants has either a mechanical, repellent or dissuasive effect against pests. In addition, some beneficial effects on the complex soil/plant agro-ecosystem can be encouraged by the release of substances or root exudates from beneficial plants. Although some degree of pest control has been scientifically verified, the degree of success depends on: the level of pest infestation, the crop density, the ratio between crops and beneficial plants, and the specific planting times. Companion planting can be used in combination with other strategies within an integrated plant and pest management to obtain healthier crops in aquaponic systems.

The table below gives a general overview of possible combinations according to biodynamic principles. Specific information can be obtained easily from the detailed literature available on organic and biodynamic agriculture.

Crop	Companions	Incompatible
Asparagus	Tomato, parsley, basil	–
Beans	Most vegetables and herbs	–
Beans, bush	Irish potato, cucumber, corn, strawberry, celery, summer savory	Onion
Beans, pole	Corn, summer savoury, radish	Onion, beets, kohlrabi, sunflower
Cabbage family (cauliflower, broccoli)	Aromatic herbs, celery, beets, onion family, camomile, spinach, chard	Dill, strawberries, pole beans, tomato
Carrots	English pea, lettuce, rosemary, onion family, sage, tomato	Dill
Celery	Onion and cabbage families, tomato, bush beans, nasturtium	–
Corn	Irish potato, beans, English pea, pumpkin, cucumber, squash	Tomato
Cucumber	Beans, corn, English pea, sunflowers, radish	Irish potato, aromatic herbs
Eggplant	Beans, marigold	–
Lettuce	Carrot, radish, strawberry, cucumber	–
Onion family	Beets, carrot, lettuce, cabbage family, summer savoury	Beans, English pea
Parsley	Tomato, asparagus	–
Pea, English	Carrots, radish, turnip, cucumber, corn, beans	Onion family, potato
Radish	English pea, nasturtium, lettuce, cucumber	Hyssop
Spinach	Strawberry, fava bean	–
Squash	Nasturtium, corn, marigold	Potato
Tomato	Onion family, nasturtium, marigold, asparagus, carrot, parsley, cucumber, basil	Potato, fennel, cabbage family
Turnip	English pea	Potato

Source: <http://permaculturenews.org/2011/12/02/companion-planting-information-and-chart/>

Appendix 3 – Fish pests and disease control

As discussed in Section 7.6.3, disease is the result of an imbalance between the fish, the pathogen/causative agent and the environment. Weakness in the animal and higher incidence of the pathogen in certain environmental conditions more favourable for the pathogen causes disease. Sound fish management practices that build a healthy immune system are the primary actions to secure a healthy stock. Fish diseases must be recognized and treated expediently. The following two tables outline symptoms and causes of common diseases, separated as abiotic and biotic, to highlight the importance of water quality and environmental conditions in disease identification.

Abiotic diseases	
Hypoxia	<p>Symptoms: fish piping, gathering at water inflow, depression or anorexia (chronic hypoxia), larger fish die with smaller fish alive, dead fish with opercula and mouth widely open.</p> <p>Causes: insufficient aeration, aeration breakdown, overcrowding, low water flow, reduction of dissolved oxygen (increased temperatures or salinity).</p> <p>Remedies: restore/empower aeration, reduce stocking density, reduce feed, monitor levels of ammonia and nitrite.</p>
Temperature stress	<p>Symptoms: lethargy, mortality of cold intolerant (hypothermia) or hot intolerant (hyperthermia) fish, mould disease (hypothermia), dyspnea (hyperthermia).</p> <p>Causes: lack of heating or insulation, breakage of thermostat, improper management.</p> <p>Remedies: insulate the tank, add a water heater, house the system in a greenhouse in cold seasons (hypothermia). Shade the tank wall, ventilate at night, setup a cooling system (hyperthermia).</p>
Ammonia poisoning	<p>Symptoms: abnormal swimming, not feeding, darker gills, larger gills (hyperplasia, for chronic toxicity), redness around eyes and fins.</p> <p>Causes: new tank syndrome, biofilter failure (various causes, also for antibiotic or antiseptic treatments to fish if carried in aquaponic tank), biofilter media recently washed/cleaned, tank overcrowding, excessive supply of feed, excessive protein in feed, reduced water flow, reduced oxygen in water, temperature drop inhibiting nitrifying bacteria.</p> <p>Remedies: immediate water exchange (20–50%), addition of zeolite (quick remedy, but low efficacy at higher salinity), reduction of pH with acid buffer, add bacteria, add biofilter media, improve oxygenation, adjust temperatures to optimal levels, stop feeding.</p>
Nitrite poisoning	<p>Symptoms: difficulty in breathing, darker gills, brownish blood, abnormal swimming such as gathering near the water surface, lethargy, redness around eyes and fins.</p> <p>Causes: new tank syndrome, biofilter failure (various causes, also for antibiotic or antiseptic treatments to fish), biofilter media recently washed/cleaned, tank overcrowding, excessive supply of feed, excessive protein in feed, reduced water flow, reduced oxygen in water, temperature drop, low Cl:NO₂ ratio.</p> <p>Remedies: immediate water replacement (20–50%), add bacteria, add biofilter media, reduce fish density, stop feeding, add chloride, improve oxygenation, adjust temperature to optimal levels, avoid fish disturbance as it causes acute mortality.</p>
Hydrogen sulphide	<p>Symptoms: characteristic smell of rotten eggs, presence of purple-violet gills, unusual swimming behaviour of fish.</p> <p>Causes: solid waste accumulation with anaerobic conditions, lack of adequate aeration, increase of temperature.</p> <p>Remedies: removal of organic wastes accumulating in anaerobic conditions, remove fish to a recovery tank until the cause has been removed, increase DO in water, increase pH, lower the temperature.</p>
pH	<p>Symptoms: low pH: acute death with trembling and hyperactivity, difficulty in breathing, increased mucus production. High pH: opacity in skin and gills, corneal damage (not common).</p> <p>Causes: low pH: nitrification occurring, low buffer in water, improper acid addition. High pH: improper buffer addition, water too rich in alkalinity/hardness. Too much carbonate in biofilter media or carbonate leaching from concrete tanks.</p> <p>Remedies: water replacement, buffer addition, add base or acid to adjust pH. In case of low pH adjust with base only if the level of ammonia is very low (risk of unionized ammonia at high pH), in case of high pH add distilled/rainwater.</p>

TABLE CONTINUED

Abiotic diseases	
Improper salinity	<p>Symptoms: skin lesions, depression.</p> <p>Causes: salinity concentrations beyond fish tolerance, replacement of water with sources with higher/lower salinity, miscalculation of salt addition (saline species), evaporative loss causing higher salt concentrations in the remaining water.</p> <p>Remedies: add deionized/rainwater or freshwater to decrease salinity, add salt to increase salinity. Addition of salt should not exceed 1 mg/litre increment per hour.</p>
Gas super-saturation (gas bubble disease)	<p>Symptoms: fish floating to surface, popped eyes due to gas emboli, presence of emboli in blood and any organs, including eyes, skin and gills.</p> <p>Causes: rapid increase of temperature or rapid decrease of water pressure that reduce the gas solubility, use of groundwater, excess water oxygenation.</p> <p>Remedies: reduce the gas in excess, avoid stress to animal during recovery.</p>
Food deficiency	<p>Symptoms: poor growth, depression, mortality, abnormality in the skeleton, ocular lesion, anaemia.</p> <p>Causes: food lacking in essential elements, improper storage of feed, lack of feed variance, low ration, blindness, excessive fat accumulation.</p> <p>Remedies: follow the fish requirements, vary the diet, provide specific pellet feed for fish, provide vitamins and minerals, balance protein:fat ratio and decrease fat (fat accumulation).</p>

Source: Modified from Noga, 1996 – See Further Reading section for full reference.

Bacterial diseases	
Columnaris (peduncle disease, fin rot, cotton wool disease, black patch necrosis)	<p>Symptoms: reddening and erosion of skin turning into shallow ulcers and necrosis, necrosis of gills, release of yellowish mucus from the lesions.</p> <p>Causes: main agent <i>Flexibacter columnaris</i>. Concurrent causes from acute stress, increase of temperatures, low oxygen, nitrite. Above 15 °C increases pathogenicity.</p> <p>Remedies: prolonged immersion in potassium permanganate to treat fish initially and increase appetite to let them eat medicated feed. Immersion in copper sulphate. Antibiotic treatment (oxytetracycline, nifurpirinol), in separate tank. Eliminate the underlying causes.</p>
Dropsy	<p>Symptoms: infection of internal organs leading to fluid accumulation in the body. The fish appear bloated.</p> <p>Causes: various bacteria, although it can be caused by parasites or a virus. Concurrent causes are also weakened fish and inadequate water/environmental standards.</p> <p>Remedies: treatment of fish with medicated feed containing antibiotics (chloramphenicol, tetracycline) in a separate tank. Elimination of water/environmental causes.</p>
Fin rot	<p>Symptoms: damaged fins with fin ray exposed, erosion, loss of colour, ulceration and bleeding. Internal septicaemia.</p> <p>Causes: bacterial infection from different agents, but <i>Pseudomonas</i> spp. more recurrent. Poor water conditions, bullying from other fish. Often pathogenic at low temperatures.</p> <p>Remedies: identify the cause(s). Treat the fish in a separate tank by providing medicated feed with non-resistant antibiotics (chloramphenicol or tetracyclin) or dissolve the antibiotic directly in the water. Keep separated until full recovered.</p>
Streptococcosis	<p>Symptoms: acute haemorrhages on body, popped eyes. Presence of sanguineous liquid in peritoneal cavity.</p> <p>Causes: <i>Streptococcus</i> spp.</p> <p>Remedies: treatment with antibiotics (oxytetracycline erythromycin, ampicillin).</p>
Tuberculosis	<p>Symptoms: emaciation, lethargy, lack in appetite, hollow belly. Skin presents ulcer, loss of scale and fin erosion. Appearance of yellow or dark tubercles on the body. Presence of 1–4 mm white nodules in internal organs especially on kidney and spleen.</p> <p>Causes: the bacteria responsible are <i>Mycobacterium</i> spp. but overcrowding, poor water quality and susceptible fish species are supplementary causes. Ingestion is the most common transmission factor. Encysted bacteria can survive two years in the environment.</p> <p>Remedies: extended treatment with erithromycin, streptomycin or kanamycin and Vitamin B-6 or elimination of the fish. Attention is required when handling as the disease may be transmitted to people.</p>
Vibrio	<p>Symptoms: skin haemorrhagic with reddening spots in the lateral and ventral part of the fish, swollen lesions turning in ulcers releasing pus. Systemic infection in kidney and spleen. Eye lesions such as eye cloudiness, ulceration, popped-out eyes and eventually organ loss. Additionally anorexia and depression.</p> <p>Causes: various type of <i>Vibrio</i> spp., more common in brackish-water and tropical fish. Increased incidence with higher temperatures. Concurrent factors in stress, crowding, organic pollution. In salmonoids, <i>V. anguillarum</i> outbreaks appear in temperatures below 5 °C.</p> <p>Remedies: timely treatment with antibiotics (oxytetracycline, sulfonamides) due to the very fast course of the disease. Reduction of stress is fundamental for long term control of the disease. Attention required when handling, as the disease may be transmitted to people.</p>

TABLE CONTINUED

Fungal diseases	
White cotton saprolegnia	<p>Symptoms: white, brown or red cottonish growth on fish surface, expanding. Ocular lesions as cloudy eyes causing blindness and loss of the organ.</p> <p>Causes: <i>Saprolegnia</i> spp. often as an opportunistic agent following other infections and overall fish weakness. Concurrent causes in acute stress, temperature drop, transport stress.</p> <p>Remedies: prolonged salt bath or formalin bath, treatment of eggs with hydrogen peroxide or prolonged immersion in methylene blue. Lesions may be treated with cloth soaked with povidone iodine or mercurochrome.</p>
Protozoan diseases	
Coccidiosis	<p>Symptoms: intestinal infestation and enteritis, epithelial necrosis. Lesions on/in internal organs such as liver, spleen, reproductive organs and swim bladder.</p> <p>Causes: Coccidia belonging to different families.</p> <p>Remedies: use of coccidiostat monensin, sulfamidimine (1 ml in 32 litres water; repeated weekly) or amprolium.</p>
Hexamitosis	<p>Symptoms: occurrence of parasite in intestine and gall bladder or other organs in more advanced cases. Presence of abdominal distension and white, mucous excrements followed by behavioural disorders such as fish hiding in corners with head down and/or swimming backwards, progressive reduction of head volume above the eyes and darkening of body.</p> <p>Causes: <i>Hexamita</i> spp. <i>Spironucleus</i> spp. flagellate protozoa attaching the intestinal tract. Affects debilitated and stressed animals.</p> <p>Remedies: use of Metronidazole both in the feed (1 %) and in the water (12 mg/litre). Addition of magnesium sulphate as a cathartic. Increase temperature and improve environmental conditions.</p>
Ich/white spot	<p>Symptoms: small white cysts (up to 1 mm) covering the body of the fish giving an appearance of salt grains that emerge, mucous skin, skin erosions. Behavioural disorders seen as lethargy, loss of appetite, and body rubbing against walls in the attempt to remove the parasite.</p> <p>Causes: <i>Ichthyophthirius multifiliis</i>.</p> <p>Remedies: the parasite is susceptible of treatment during the free-swimming stage of juveniles (theronts) following the adult stage on the fish (trophont) and the production of cysts (tomont) that fall on the bottom. Treatment with salt bath or formalin bath every week until cured. Maintain water temperature above 30 °C for 10 days. Raising the temperature from 21–26 °C shortens the cycle of the parasite from 28 to 5 days making the treatment period in curative bath shorter.</p>
Trichodina	<p>Symptoms: a wet mount (microscopy) of skin scraping will show the parasite. A grey film on skin and gills, along with an excess of white mucous secretion. Anorexia and loss of condition in heavily infested fish.</p> <p>Causes: saucer-shaped protozoan parasite that attaches to gills and the body surface of the host fish. Often found in poor water quality and overstocking.</p> <p>Remedies: formalin or potassium permanganate bath. Salt or acetic acid bath immersion (freshwater protozoa only).</p>
Velvet/Dust	<p>Symptoms: brownish dust covering the body and/or the fins. Respiratory discomfort (out-of-breath) with quick gill movement due to presence of parasite on the gills, cloudy eyes. Formation of cysts that discharge free infective parasites.</p> <p>Causes: <i>Piscinodinium</i> spp. a parasitic skin flagellate that binds to the host.</p> <p>Remedies: disease is highly contagious and fatal. Raising temperatures at 24–27 °C speeds up the cycle for treatments. Leaving the system with no fish for two weeks to remove the protozoan. For heavy infestation a bath with 3.5 % salt for 1–3 minutes is effective to remove the trophonts. Alternatively, treatment with copper sulphate at 0.2 mg/litre in a separate tank, repeated as necessary. Copper can bioaccumulate and cause toxicity.</p>
Parasitic diseases	
Anchor worm, lice	<p>Symptoms: presence of parasites on skin, gill, mouth. Erosion and ulceration. Red spots on skin that can raise up to 5 mm.</p> <p>Causes: copepods of various origin, introduced from the wild.</p> <p>Remedies: identifiable with magnifying lens, extended treatment in salt (freshwater species). Also hydrogen peroxide, formalin and ivermectin are remedies for lice.</p>
Flukes	<p>Symptoms: scraping on tank walls, release of mucus from gills, fast gill movement, gill and fins damages. Paleness, quick respiration and flopping fins.</p> <p>Causes: flatworms about 1 mm long infesting gills and skin. Detectable with magnifying lens.</p> <p>Remedies: treatment of 10 to 30 minute bath in 10 mg per litre of potassium permanganate in a separate tank (freshwater parasite only). Salt bath (freshwater parasite only). Formaline or copper bath.</p>
Leeches	<p>Symptoms: presence of parasites on the skin creating small red or white lesions. Heavy infestations lead to anaemia.</p> <p>Causes: external parasites mainly introduced from wild.</p> <p>Remedies: avoid introduction of raw plants or snails, bath in salt solution, use of organophosphates.</p>
Nematoda	<p>Symptoms: progressive loss of weight, lethargy, void bellies and accumulation of parasites around the anus. Colonization of viscera with 0.6–7.0 mm worms in the intestine.</p> <p>Causes: threadworms infesting all over the body but are visible when they concentrate at the anus. Infestation occurs with introduction of wild or pond fish.</p> <p>Remedies: medicated feed with fenbendazole oral, levamisole oral.</p>

Source: Modified from Noga (1996) – See Further Reading section for full reference.

Appendix 4 – Calculating the amount of ammonia and biofilter media for an aquaponic unit

This appendix provides detailed explanations on the optimal amount of filtration media required to convert the ammonia into nitrate from a given amount of fish feed. In addition to the information provided in Chapter 8 of the main text of this publication, it is important to introduce two new parameters in the equations:

- total ammonia nitrogen (TAN) produced by fish feed
- conversion rate of ammonia to nitrate by bacteria

DETERMINING THE AMOUNT OF AMMONIA PRODUCED BY FEED

Ammonia is a by-product from the degradation of proteins. The amount of ammonia in the water depends on several factors, including the quantity/quality of proteins or amino acids in the feed, the digestibility, the fish species, the temperature, and the removal of fish wastes from the aquaponic system. On average, 30 percent of the proteins supplied by the diet are retained in the fishes' body. Therefore, 70 percent of the nitrogen is lost: 15 percent is not digested, and exits as solid waste (faeces) and uneaten feed, while the remaining 55 percent is excreted by the fish as ammonia or products easily degradable into ammonia. In addition to the wastes directly dissolved, it is worth noticing that about 60 percent of the solid waste produced is taken out from the system by means of clarifiers or settlers, which leaves about 6 percent of the solid waste to be degraded into ammonia in the water. Overall, about 61 percent of the nitrogen from the feed becomes ammonia and is subject to nitrification.

Take the example of 20 kg of fish eating 1 percent of their body weight per day (200 g of fish feed). From these 200 g of feed (32 percent protein), the amount of ammonia produced is approximately 7.5 grams. To achieve this result, first the amount of nitrogen is calculated based on the percentage of protein in the feed; and the amount of nitrogen contained in the protein (16 percent). Then, the amount of wasted nitrogen is calculated: 61 percent of the nitrogen is wasted (6 percent as undigested/uneaten feed retained into the system; 55 percent excreted by fish). For each gram of wasted nitrogen, 1.2 g of ammonia is produced, according to standard chemistry methods (not included here). The following equation shows the process:

$$200 \text{ g feed} \times \frac{32 \text{ g protein}}{100 \text{ g feed}} \times \frac{16 \text{ g nitrogen}}{100 \text{ g protein}} \times \frac{61 \text{ g wasted nitrogen}}{100 \text{ g total nitrogen}} \times \frac{1.2 \text{ g NH}_3}{1 \text{ g nitrogen}} = 7.5 \text{ g ammonia}$$

DETERMINING THE AMOUNT OF BIOFILTER MEDIA NEEDED BY NITRIFYING BACTERIA

The ammonia removal rate by nitrifying bacteria is 0.2–2 g per square metre per day. The removal rate depends on the biofilter design, water load (amount of water flowing through the bacteria), temperatures (higher biological activity at > 20 °C), salinity, pH, oxygen as well as suspended solids from fish wastes. To simplify the complex calculations needed, a conservative rate is used: 0.57 g of ammonia is converted per square metre of surface area per day. Given a daily amount of feed of 200 g and the resulting production of 7.5 g of ammonia, it is necessary to provide bacteria with an operating surface area of 13.3 m², as shown in the following equation:

$$7.5 \text{ g ammonia} \times \frac{1 \text{ m}^2}{0.57 \text{ g ammonia}} = 13.3 \text{ m}^2$$

The surface for bacteria can be obtained from a wide choice of materials, each with a specific surface area (SSA), also known as the surface area to volume ratio, expressed as square metres per cubic metre (m^2/m^3). Common biofilter media include gravel, sand, fibre mesh pads and plastic filter medium. The SSA indicates the total surface that one cubic metre of a particular material would have if all its particles had their surface area measured. Some of these SSA values are recorded in Table A4.1 (see also Table 4.1). The volume of media required to convert the ammonia can be calculated using the SSA ratios. An example using volcanic tuff is provided in the following equation.

Volcanic tuff has an SSA of $300 \text{ m}^2/\text{m}^3$. The volume of tuff needed to guarantee an operating surface of 13.3 m^2 , calculated above, for nitrifying bacteria can be obtained with a simple division:

$$13.3 \text{ m}^2 \times \frac{1 \text{ m}^3}{300 \text{ m}^2} = 0.0443 \text{ m}^3$$

The final volume of tuff required to process 200 g of feed per day is 0.0443 m^3 . One cubic metre is equivalent to 1 000 litres, and therefore the volume of tuff required is 44.3 litres. Hence, 1 litre of tuff can convert the ammonia obtained by 4.5 g of feed.

$$\frac{44.3 \text{ litres tuff}}{200 \text{ g feed}} : \frac{1 \text{ litre tuff}}{4.5 \text{ g feed}}$$

When using media bed aquaponic techniques, the amount of media used for plant growing far exceeds the minimum amount required for biofiltration and conversion of ammonia. This results in a robust system in the event of a severe reduction of the efficiency of the nitrifying bacteria. The system design described in Appendix 8 of this publication has a tuff volume of 900 litres, almost 20 times higher than the volume needed to process the ammonia produced from 200 g of feed.

TABLE A4.1

Specific surface area of selected biofilter media, including calculations of ammonia conversion of daily feeding, assuming 32 percent protein in feed

Type of media	Specific surface area (m^2/m^3)	Feed (g) processed per litre of media	Media required (litres) per 100 g of feed
Coarse sand (0.6–0.8 mm)	5 000	75.0	1.3
Bead filtration	1 400	21.0	4.8
Bioballs®	600	9.0	11.1
Foam	400	6.0	16.7
Fibre mesh pads	300–400	4.5–6.0	16.7–22.2
Corrugated structured packing	150–400	2.3–6.0	16.7–44.4
Volcanic gravel	300	4.5	22.2
Clay balls (LECA)	200–250	3.0–3.8	26.7–33.3
Coarse gravel	150	2.3	44.4

It is possible to use any biofilter medium and determine the volume needed by knowing the SSA. However, it is worth mentioning that the larger the SSA in the media is, the higher the risk of clogging if the water has some suspended solids, which can easily occur in overstocked aquaponic systems that are not adequately supplied with clarifiers or settlers to remove fish wastes.

Appendix 5 – Making homemade fish feed

Fish feed is one of the most expensive inputs for a small-scale aquaponic unit. Feed is also one of the most important components of the whole aquaponic ecosystem because it sustains both the fish and vegetable growth. Therefore, it is necessary that farmers and practitioners understand its composition. Also, if commercial pelleted feed is not available, it is important to understand the methods to produce it on the farm. Moreover, homemade feed is useful when specific diets are needed to improve fish growth or aquaponic system performance.

COMPOSITION OF FEED

Fish feed consists of all the nutrients that are required for growth, energy and reproduction. Dietary requirements are identified for proteins, amino acids, carbohydrates, lipids, energy, minerals and vitamins (Table A5.1). A brief summary of major feed components, compositional tables and formulations is presented as a guide for the feed preparation process.

Proteins

Dietary proteins play a fundamental role for the growth and metabolism of animals. They are made of 20 different amino acids, reassembled in innumerable combinations to provide all the indispensable proteins for life and growth.

Only some amino acids can be synthesized by animals while others cannot; these must be supplied in the diet. For aquatic animals, there are 10 essential amino acids (EAAs): arginine, histidine, isoleucine, leucine, lysine, methionine, phenylalanine, threonine, tryptophan and valine. Therefore, feed formulation must find an optimal balance of EAAs to meet the specific requirements of each fish species. Non-compliance with this requirement would prevent fish from synthesizing their own proteins, and also waste the amino acids that are present. The ideal feed formulation should thus take into account the EAA levels of each ingredient and match the quantities required by fish. Information on the level of EAAs (especially methionine, cysteine and lysine) is available in any feed ingredients datasheet (see Further Reading).

Recommended protein intake of fish depends on the species and age. While for tilapia and herbivorous fish the optimal ranges are 28–35 percent, carnivorous species require 38–45 percent. Juvenile fish require higher-protein diets than adults owing to their intense body growth.

Besides any optimal amino acid content in the feed, it is worth stating the importance of an optimal dietary balance between proteins and energy (supplied by carbohydrates and lipids) to obtain the best growth performance and reduce costs and wastes from using proteins for energy. Although proteins can be used as a source of energy, they are much more expensive than carbohydrates and lipids, which are preferred.

In aquaponics, any increase in dietary proteins directly affects the amount of nitrogen in the water. This should be balanced either by an increase in plants grown in the system or the selection of vegetables with higher nitrogen demands.

In general, the total amount of crude protein (CP) or a specific EAA from a formulated feed can be simply obtained by multiplying the CP (or the percentage of the specific EAA being investigated) of each ingredient by the percentage of its inclusion, and by finally summing all the subtotals obtained. For example, a diet with 60 percent

of soybean with 44 percent CP and 40 percent of wheat grain with 18.8 percent CP would be equal to $\rightarrow (0.6 \times 44) + (0.4 \times 18.8) = 26.4 + 7.52 = 33.9$ percent CP. If the CP obtained by the calculation (or the amount of the specific EAA) meets the CP requirements of the fish (or the specific EAA percent) the diet is considered optimal.

The identification of the cheapest protein sources can be made by simply dividing the cost of each ingredient by the percentage of its crude protein. The results will give the cost of a unit of protein (1 percent) and can help find the most cost-effective feed formula.

Carbohydrates

Carbohydrates are the most important and cheapest energy source for animals. They are mainly composed of simple sugars and starch, while other complex structures such as cellulose and hemicellulose are not digestible by fish. In general, the maximum tolerated amount of carbohydrates should be included in the diet in order to lower the feed costs. Omnivorous and warm-water fish can easily digest quantities up to 40 percent, but the percentage falls to about 25 percent in carnivorous and cold-water fish. Carbohydrates are also used as a binding agent to ensure the feed pellet keeps its structure in water. In general, one of the most used products in extruded or pelleted feed is starch (from potato, corn, cassava or gluten wheat), which undergoes a gelatinization process at 60–85 °C that prevents pellets from easily dissolving in water.

Lipids

Lipids provide energy and essential fatty acids (EFAs) indispensable for the growth and other biological functions of fish. Fats also play the important role in absorbing fat-soluble vitamins and securing the production of hormones. Fish, as other animals, cannot synthesize EFAs, which have to be supplied with the diet according to the species' needs. Deficiency in the supplement of fatty acids results in reduced growth and limited reproductive efficiency.

In general, freshwater fish require a combination of both omega-3 and omega-6 fatty acids, whereas marine fish need mainly omega-3. Tilapias mostly require omega-6 in order to secure optimal growth and high feed conversion efficiency. Most diets are comprised of 5–10 percent lipids, although this percentage can be higher for some marine species. Lipid inclusion in the feed needs to follow optimal protein/energy ratios to secure good growth, to avoid misuse of protein for energy purposes (lack of fat/carbohydrates for energy purposes) and to avoid fat accumulation in the body (diet too rich in lipids).

Energy

Energy is mainly obtained by the oxidation of carbohydrates, lipids and, to a certain extent, proteins. The energy requirements of fish are much lower than warm-blooded animals owing to the reduced needs to heat the body and to perform metabolic activities. However, each species requires an optimum amount of protein and energy to secure best growth conditions and to prevent animals from using expensive protein for energy. It is thus important that feed ingredients be carefully selected to meet the desired level of digestible energy (DE) required by each aquatic species. A brief reference on optimal protein and energy balance in most common fish for aquaponics is provided below (Table A5.1). Information on the level of DE is available in any feed ingredients datasheets (see the fish feed section in the Further Reading).

In general, the value of DE from a formulated feed can be simply obtained by multiplying the DE of each ingredient by the percentage of its inclusion and by summing all the subtotals obtained (e.g. a diet with 60 percent of soybean with DE 2 888 kcal/kg and 40 percent of wheat grain with DE 2 930 kcal/kg would be equal to $\rightarrow [0.6 \times 2\ 888] + [0.4 \times 2\ 930] = 1\ 732 + 1\ 172 = 2\ 904$ kcal/kg). If the energy obtained

by the calculation meets the energy (and protein) requirements of the fish cultured, the diet is optimal.

TABLE A5.1

Optimal protein, energy, DP/DE ratio and essential amino acid requirements of selected fish species

Species	Digestible protein (DP)	Digestible energy (DE)	DP/DE	Arginine	Histidine	Isoleucine	Leucine	Lysine	Methionine	Phenylalanine	Threonine	Tryptophan	Valine
	(%)	(kcal/kg)	(mg/kcal)	(% of dry diet)									
Nile tilapia	30	2 900	103	1.2	0.5	0.9	0.9	1.4	0.7	1.0	1.0	0.3	0.8
Common carp	32	2 900	108	1.5	0.8	0.9	1.3	2.2	1.2	2.5	1.5	0.3	1.4
Rainbow trout	42	4 100	105	1.6	–	–	–	1.9	1.0	–	–	0.3	–
Channel catfish	27	3 100	86	1.0	0.4	0.6	0.8	1.2	0.6	1.2	0.5	0.1	0.7

Source: modified from NRC (1993).

Vitamins and minerals

Vitamins are organic compounds necessary to sustain growth and to perform all the physiological processes needed to support life. Vitamins must be supplied with the diet because animals do not produce them. Vitamin deficiencies are most likely to occur in intensively cultured cages and tank systems, where animals cannot rely on natural food. Degenerative syndromes are often ascribed to an insufficient supply of these vitamins and minerals.

Minerals are important elements in animal life. They support skeletal growth, and are also involved in osmotic balance, energy transport, neural and endocrinal system functioning. They are the core part of many enzymes as well as blood cells. Fish require seven main minerals (calcium, phosphorus, potassium, sodium, chlorine, magnesium and sulphur) and 15 other trace minerals. These can be supplied by diet, but can also be directly absorbed from the water through the skin and gills. Supplementing of vitamins and minerals can be done according to the requirements of each species (Table A5.2).

TABLE A5.2

Common feed ingredient sources of the most important nutrient components

Nutrient components	Feed ingredient sources
Protein	Plant-based sources: algae, yeast, soybean meal, cottonseed meal, peanuts, sunflower, rapeseed/canola, other oil-seed cakes. Animal-based sources: fishery by-products (fishmeal or offal), poultry by-products (poultry meal or offal), meat meal, meat and bone meal, blood meal.
Carbohydrates	Wheat flour, wheat bran, corn flour, corn bran, rice bran, potato starch, cassava root meal.
Lipids	Fish oil, vegetable oil (soybean, canola, sunflower), processed animal fat.
Vitamins	Vitamin premix, yeast, legumes, liver, milk, bran, wheat germ, fish and vegetable oil.
Minerals	Mineral premix, crushed bone.

ON-FARM FEED PRODUCTION

The production of feed requires a fine balance of all of the nutrient components mentioned above (protein, lipids, carbohydrates, vitamins, minerals and total energy). An unbalanced feed will cause reduced growth, nutritional disorders, illness and, eventually, higher production costs.

Fishmeal is regarded as the best protein source for aquatic animals because of its very high protein content and it has balanced EAAs. However, it is an increasingly expensive ingredient, with concerns regarding sustainability. Moreover, fishmeal is not always available. Proteins of plant origin can adequately replace fishmeal; however, they should undergo physical (de-hulling, grinding) and thermal processes to improve their digestibility. Plant ingredients are, in fact, high in antinutritional factors that interfere with the digestion and the assimilation of nutrients by the animals, which eventually results in poor fish growth and performance.

The size of the pellets should be about 20–30 percent of the fish's mouth in order to facilitate ingestion and avoid any loss. If the pellets are too small, fish exert more energy to consume them; if too large, the fish will be unable to eat. A recommended pellet size for fish below 50 g is 2 mm, while 4 mm is ideal for pre-adults of more than 50 g.

The use of any raw ingredient of animal origin (fish offal, blood meal, insects, etc.) should be preventively heat treated to prevent any microbial contamination of the aquaponic system.

HOMEMADE FISH FEED FORMULATIONS FOR OMNIVOROUS/HERBIVOROUS FISH

Two simple recipes for a balanced fish feed containing 30 percent of CP are provided below. The first formulation is made with proteins of vegetable origin, mainly soybean meal. The second formulation is mainly made with fishmeal. The lists of the ingredients for each diet are expressed in weight (kilograms), enough to make 10 kg of feed, in Tables A5.3 and A5.4. A simple step-by-step guide on preparation of the pelleted feed is then provided. Extensive information on feed, nutrition and formulation can be found on the FAO website listed in the section on Further Reading of the publication.

TABLE A5.3

List and relative amounts of ingredients for 10 kg of fish feed using vegetable-based protein, including proximate analysis

Feed ingredients	Weight (kg)	Percentage of total feed (%)	Proximate analysis	%
Corn meal	1.0	10	Dry matter	91.2
Wheat flour	1.0	10	Crude protein	30.0
Soybean meal	6.7	67.2	Crude fat	14.2
Soybean oil	0.2	2	Crude fibre	4.8
Wheat bran	0.7	7.8	Ash	4.6
Vitamin and mineral premix	0.3	3	Nitrogen-free extract (NFE)	28.3
Total amount	10.0	100	–	–

TABLE A5.4

List and relative amounts of ingredients for 10 kg of fish feed using animal-based protein, including proximate analysis

Feed ingredients	Weight (kg)	Percentage of total (%)	Proximate analysis	%
Corn meal	1.0	10	Dry matter	90.9
Wheat flour	4.0	40	Crude protein	30.0
Soybean meal	1.5	15	Crude fat	10.5
Soybean oil	0.2	2	Crude fibre	2.1
Fishmeal	3.0	30	Ash	8.3
Vitamin and mineral premix	0.3	3	Nitrogen-free extract (NFE)	34.5
Total amount	10.0	100	–	–

Step-by-step preparation of homemade fish feed

1. Gather the utensils as outlined in Table A5.5.
2. Gather the ingredients shown in Table A5.3 or Table A5.4. Purchase previously dried and defatted soybean meal, corn meal and wheat flour. If these meals are unavailable, obtain whole soybeans, corn kernels, and wheat berries. These would need to be dried, de-hulled and ground. Moreover, whole soybeans need to be toasted at 120 °C for 1–2 minutes.
3. Weigh each ingredient following the quantities shown in the recipes above.
4. Add the dry ingredients (flours and meals) and mix thoroughly for 5–10 minutes until the mix becomes homogeneous.
5. Add the vitamin and mineral premix to the dry ingredients and mix thoroughly for another 5 minutes. Make sure that the vitamins and minerals are evenly distributed throughout the whole mixture.
6. Add the soybean oil and continue to mix for 3–5 minutes.
7. Add water to the mixture to obtain a soft, but not sticky, dough.
8. Steam-cook the dough to cause gelatinization.
9. Extrude the dough. First divide the dough into manageable pieces, and pass them through the meat mincer/pasta maker to obtain spaghetti-like strips. The mincer disc should be chosen according to the desired pellet size.
10. Dry the extruded dough by spreading the strips out on aluminium trays. If available, dry the feed strips in an electric oven at a temperature of 60–85 °C for 10–30 minutes to gelatinize starch. Check the strips regularly to avoid any burn.
11. Crumble the dry strips. Break or cut the feed on the tray with the fingers into smaller pieces. Try to make the pellets the same size. Avoid excessive pellet manipulation to prevent crumbling. Pellets can be sieved and separated in batches of homogeneous size with proper mesh sizes.
12. Store the feed. Place the fully-dried feed pellets into airtight plastic containers soon after they have been broken into pieces to prevent them absorbing humidity.

TABLE A5.5

List of tools and materials needed for feed formulation

Component	Quantity	Specifications
Weighing scale	1	Capacity 1–3 kg, divisions of 1 g
Grinder	1	Electric coffee-type grinder
Metal sieve	1	0.2–0.4 cm mesh
Mixing bowl	1	Capacity 10 litres
Plastic bowl	3	Capacity 2 litres
Meat mincer / pasta maker	1	Manual or electric
Mixing spoon	1	Large size
Aluminium baking tray	10	40 × 40 cm or other available sizes

STORING HOMEMADE FEED

Once prepared, the best way to store fish feed is to put pellets into an airtight container soon after being dried and broken apart. Containers must be kept in a cool, dry, dark and ventilated place, away from pests. Keeping pellets at low levels of moisture (< 10 percent) prevents them becoming mouldy and developing toxic mycotoxins. Depending on the temperature, the pellets can be stored for as long as two months.

Another way to keep pellets for long periods is to close them in a plastic container and store them in the fridge, though this would require electricity. Feed can be kept in this way for more than one year.

Feed must be used on a “first in, first out” basis. Avoid using any feed showing signs of decay or mould, as this could be fatal for fish.

SUPPLEMENTARY FEEDING WITH LIVE FEEDS

Fish can be advantageously supplied with supplementary feeds that are locally available. The use of fresh feed would in fact provide animals with supplementary proteins for their growth. It can also provide vitamins or minerals that might be deficient in the pellets.

A wide range of live feeds is available – the choice depends on the fish cultured and local availability. However, it is very important to remember that any feed coming from external sources might bring micro-organisms or parasites if collected from outside waters (contaminated or polluted) or if from animal origin (e.g. worms from non-pasteurized animal manure). Live feeds can be produced at home level under safer standards or can be heat-treated before being given to fish.

Examples of live fish feed include:

- Duckweed and aquatic macrophytes. Duckweed is quite rich in proteins and can be supplied raw for up to 10 percent of the daily ration. However, macrophytes are less digestible than formulated feed owing to their higher fibre content, which would also increase the amount of solids/wastes in the system.
- Crop residues from aquaponics or other sources can be supplied to herbivorous/omnivorous fish in small amounts.
- Earthworms are readily obtainable from green compost piles, especially in rural areas. A starve period of 1–2 days is recommended if worms come from outside sources in order to reduce the risk of introducing bacteria into the system.
- Insect larvae are very rich in proteins, but care should be taken not to use them in excessive quantities owing to their higher lipid content. Larvae can be cultured on rotten organic matter (vegetables, fruits); however, a starve period of 1–2 days is recommended if the substrate contains material of animal origin.
- Insects can be given to omnivorous or carnivorous fish species, but the presence of the exoskeleton of chitin reduces their digestibility.
- Small fish, crustaceans and molluscs are available from streams or ponds. However, prudence may be needed owing to the risks of contamination and parasites.
- Algae can easily be supplied to herbivorous/omnivorous fish. Algae can be cultivated in separate tanks beside the aquaponic system and harvested.

Appendix 6 – Key considerations before setting up an aquaponic system

There are many fully functioning commercial and small-scale aquaponic units around the world. Aquaponic systems can be developed not only in tropical and subtropical regions, where favourable climatic conditions allow year-round production, but also in cooler areas of the world where winter seasons last up to six months. The question of running an aquaponic system in a specific place requires a comprehensive cost-benefit analysis that should assess its possible success upon certain economic, environmental, logistical/managerial and social conditions.

Many factors must be considered before embarking on an aquaponic project, whether it is for domestic production or more commercially focused. Many start-up aquaponic businesses have failed. A decision to create a commercial enterprise requires significant research, a business plan and a risk analysis. Such aspects are beyond the scope of this appendix. However, it does discuss below some of the key factors and requirements for operating any size aquaponic unit.

ECONOMIC FACTORS

One of the main factors that determine the possible success of aquaponics is its competitiveness against alternative production methods. The combination of both fish and plants doubles the risks of the investment that, in order to be profitable, must maximize both plant and fish production and revenues.

This implies that an analysis on the potential markets is an essential step towards the development of a business plan, as it should realistically find all the possible products, identify the profit margins and identify the key customers. A common mistake is to ask: “What can I produce?” instead of the more important questions: “What can I sell?”, “To whom am I going to sell?”, and only then “How am I going to produce it?”

Market analysis should identify the most profitable products and the most cost-effective management. This implies that the specific choice of fish can be significantly different from the species generally used in aquaponics, mainly owing to market demand and the costs of production.

In the decision-making process, there are substantial differences between a production focused for self-consumption and a market-oriented one. While the former can mostly rely on retail prices to estimate the profit margins, the commercial-scale ventures have to find markets that might be closer to wholesale prices, especially in the case of large-scale operations. However, small-scale systems cannot benefit from economies of scale (e.g. a small greenhouse has a higher cost per square metre than does a larger one), which means non-commercial farmers may face higher production costs.

While aquaponics may, to some extent, be acknowledged as an “organic” production option in North America, this is not equally true in Europe where “organic” still applies only to soil-based production. The positive outlook derived from a more ecologically sound production can favour higher revenues in Western markets; however, this may not be equally possible in developing countries where customers’ choices are still primarily price-oriented. On the marketing side, an advantage could come from footprint labelling, as aquaponics appears to be the best aquaculture system in terms of water conservation and a pollution-free solution that can support agriculture

with consistent savings in fertilizers and chemical inputs. However, proper product development on this basis still needs to be done, providing also that aquaponics moves towards more energy-neutral management strategies.

One of the limits that still prevents aquaponics from fully expanding worldwide is that its investment costs are almost double those of standard hydroponic farming. However, this conviction is partly derived from the mistaken idea that aquaponics is a mere plant production system rather a recirculating aquaculture system (RAS) that additionally supports agriculture. If compared against a standard RAS, aquaponics shows consistent advantages in terms of capital and operating costs and for the degree of simplicity of the system. Greater success could be achieved if cost-saving designs/projects were able to bring aquaponic setups closer to the investments costs of hydroponics. However, this would require more effort to focus on developing simpler systems.

The possibility to set up aquaponics in unfavourable climates depends on the degree of investments needed for building greenhouses and running advanced climate control systems to maintain optimal water and air temperatures, humidity and ventilation. This would increase the initial and running costs, but at least, on this level, the investment costs for the greenhouse facilities may not differ significantly from those for hydroponics.

ENVIRONMENTAL FACTORS

There are some key considerations in determining where aquaponics is most applicable and beneficial. Regions in the world where soil fertility is poor (and particularly where replenishing the soil with nutrients via organic material is difficult and/or expensive) and water is scarce are the ideal locations. Aquaponics is competitive with even the most productive traditional aquaculture and agriculture systems in terms of water use. Aquaponic food production is extremely water efficient, as the vegetable growing methods are soil-less. However, to compete against hydroponics, fish-plant systems should be considered as a whole in order to justify higher installation costs. When taking these factors into consideration, semi-arid regions with poor access to water would stand to benefit the most from this new method of food production.

Water is a significant factor, especially for quality standards. Aquaponics has the great advantage of recirculating water, which avoids any need to procure large daily volumes to compensate for losses. In areas where water is muddy, contaminated by pollutants or pathogens/parasites, aquaponics, as well as RAS, is an ideal system to optimize fish production, reduce mortality of aquatic animals and improve quality. In this case, the extra investments needed to supply small volumes of good-quality water (e.g. through rain harvest or artesian wells) can be easily recovered by the added value from higher-quality fish and lower mortality rates.

Salinity levels in water are the next step in the water assessment process. While freshwater fish can tolerate certain levels of salinity, increases in water electric conductivity (EC) above a certain levels (e.g. 2 000 microSiemens) limits the growth of salt-intolerant vegetables. This would push agricultural producers to consider just salt-tolerant species, with potential risks of reduced profits owing to market conditions which may not be so receptive. In addition, the buildup of nutrients and salinity through the seasons as a result of imbalances between system intake (feed) and plant uptake could equally bring the aquaponic units to face increased salinity problems. These would need to be solved through moderate water dumping or modified management (limitation in feed use, cropping with salt-absorbing plants) that might reduce systems' profitability or productivity and may require a higher level of expertise in operators.

Climate is another major factor, as it will determine the extra cost for each unit to maintain the ideal environmental conditions for aquaponic food production. In general, regions where the average daily air temperatures throughout the year are 20–30 °C are

the ideal for tropical fish, such as tilapia, and warmth-tolerant plants. Therefore, the choices of crops and fish significantly affect the costs if climatic control is needed to match the ideal growing conditions of both components. Moreover, regions where average daily air temperatures are favourable, but widely fluctuate during the day and night (i.e. highlands and mountainous regions), would be particularly problematic for fish production. This is because large changes cause stress to the animals.

Attention must also be paid to the seasons. Cold winter seasons will force aquaponic farmers to either invest in energy-demanding heating systems for their greenhouses or stop production entirely for certain months. It is thus important to study the production setup carefully and possibly find alternative species that avoid unproductive sections of the year.

Extended rainy seasons force farmers to protect their units with strong canopies or greenhouses, as large volumes of rain could damage crops, cause the systems to overflow or to dilute excessively the nutrients in water. However, if on the one hand this need requires extra investments, on the other it can be profitable in areas where traditional agriculture is severely limited owing to flooding or nutrient runoff. The same solution also pertains to wind, as the presence of a protected environment could bring higher yields and better quality of vegetable products, while traditional agriculture would struggle.

Summer seasons can cause water overheating. Although methods to keep temperatures relatively low during hot periods are quite simple and can be supported with proper system designs, it is possible that water temperatures would rise to suboptimal levels during extremely hot periods if no water cooling systems were used. This would limit farmers' vegetable growth and selection, even though it may not affect tropical fish or nitrifying bacteria.

LOGISTICAL AND MANAGERIAL FACTORS

Fish production is an important component of aquaponic operations. Easy access to aquatic animals is fundamental for farmers, as is the possibility to gain expertise on fish and knowledge of locally cultured fish.

Aquaponic expansion is thus limited in regions where there are no hatcheries, aquaculture production or extension services – unless broodstock, fingerling and fish feed productions are all part of the aquaponic business plan. Even then, the investment appears riskier, as it implies longer periods to make the farm fully operative, and the need to dedicate more time for knowledge transfer and to scope potential local and regional markets where to sell the production.

At any location, access to electricity and appropriate water is essential. Particularly for electricity, the access to a constant and reliable power-grid is fundamental to secure the continuous functioning of pumps. The lack of this resource would severely limit the expansion of aquaponics unless low-yielding systems are designed to withstand power cuts of several hours without affecting fish survival. Aquaponic operations, especially if they are meant for commercial purposes, must rely on backup systems and generators, which increase the setup costs. Fish production is one of the most complicated aspects of aquaponics (particularly for farmers new to aquaculture), demanding daily management and care to avoid significant losses if any system failure occurs.

There must also be a market for key aquaponic components and monitoring tools (water test kits, pH meters, EC meters), which a local aquaculture market would normally facilitate. A determinant factor for the success of any aquaponic setup is the use of locally available materials and the sensible adaptation of systems to local contexts and resources. Failing this, it would be difficult to develop any cost-effective method of producing food.

Educational capacity is also a key factor when selecting specific locations within regions or countries. Aquaponics is a relatively sophisticated method of food

production compared with traditional soil-based approaches. The method demands a higher level of understanding of this integrated ecosystem as well as the major factors that influence it (water, environment, nutrition, etc.). It also demands good individual aquaculture and horticulture knowledge that must be transferred and adapted to local contexts. The major challenge that aquaponics faces in order to become a sustainable option among illiterate or semi-illiterate farmers and/or end users is to reduce its levels of complexity by adapting the technology, or at least the concept, to local resources, needs and cultures. Adapting and contextualizing the systems would bring them closer to those fish/plant systems that have dominated agricultural practices for thousands of years. This would require a better knowledge among practitioners on how to design systems where every single component or material could reduce management needs to a minimum.

Where aquaponic food production is virtually non-existent within a specific region, it is beneficial to partner with local universities or agricultural extension institutes in order to develop knowledge on best practices and on how to develop aquaponics in a very simple and effective way.

SOCIAL CONDITIONS

Beyond the adoption of fish–plant systems as a competitive food production method, aquaponics has still not acquired a well-defined outlook. While aquaponics is widely accepted as an organic production method in North America, the same cannot be seen in Europe and this reduces its potential to gain premium prices.

Among consumers and researchers, there are also some concerns that aquaponic water is a vector of potential bacteria contaminations owing to fish faecal wastes. Although different countries use different regulations on water safety, the development of aquaponics may be limited in those countries where the limit for bacteria is more stringent. This would require an increase in efforts to comply with local standards (e.g. by using sterilizing technology), even though aquaculture wastewater is safer than other water sources.

On the other hand, aquaponics can provide an opportunity to produce safer food that is chemical-free and disease-free. In the case of the aquaculture industry, this may be an added-value characteristic that may raise interest in this production system. Recent concerns about pesticide use in agriculture have led many consumers in developing countries to buy safer products. These consumption patterns must be accurately monitored in the decision-making process as to whether aquaponics is feasible in a particular area or not.

SUMMARY OF ESSENTIAL REQUIREMENTS FOR AQUAPONICS AT DIFFERENT SCALES

Table A6.1 summarizes the key considerations for aquaponic ventures on various scales.

TABLE A6.1
Key considerations for aquaponic ventures on various scales

Essential requirements	Small-scale (50–500 lettuce heads)	Semi-commercial (500–2 500 lettuce heads)	Large-scale commercial (>2 500 lettuce heads)
Optimal climate and environmental conditions for aquaponics	X	X	X
Access to good-quality fish fry, fingerlings and seeds/seedlings	X	X	X
Access to aquaponic components	X	X	X
Access to electricity and quality water at the unit site at all times	X	X	X
Feasible methods for climatic and environmental control in protected environments (greenhouses)		X	X
Access to water monitoring tools (oxygen and pH meters, water test kits)		X	X
Equipment for effective large-scale, fish-solid-waste capture and biofiltration (swirl separators, clarifiers, etc.)		X	X
Sludge waste management		X	X
Backup power generators		X	X
Biosecurity and integrated pest management protocols		X	X
Good experience with both aquaculture and horticulture methods		X	X
Business plan including extensive market research	X	X	X
Aquaculture and hydroponic specialists on staff or on call			X
Fry production facility, on-site water-quality laboratory and extension services for fish disease identification and treatment			X
Automated methods to monitor and regulate oxygen and water parameters			X

Appendix 7 – Cost-benefit analysis for small-scale aquaponic units

Tables A7.1–A7.4 describe the costs and benefits of a small-scale aquaponic unit. The information in the tables is meant to provide the reader an understanding of the expenses necessary to build and run an aquaponic unit, as well as the expected production and incomes in the first year. Table A7.1 summarizes the total cost of materials for the initial installation (capital investment) for a small-scale media bed unit (the full list of materials and costs for this unit can be found in Appendix 8 of this publication). Table A7.2 details all the yearly running costs involved. The details of the running cost calculations can be found in the notes section of the table. Table A7.3 details the expected production of vegetables and fish in one year. Table A7.4 brings together the costs and revenues from Tables A7.1–A7.3 and shows the total profit on the initial investment and the payback period.

It should be noted that the figures given in the tables are only intended as guidelines for new users. It is difficult to provide accurate figures, particularly regarding production yields and their values, as many production and financial factors may influence them: temperatures, seasons, fish type, fish feed quality and percentage protein, markets prices, etc.

CALCULATION ASSUMPTIONS

- All calculations are based on a small-scale media bed unit (described throughout the main text of this publication) with 3 m² of growing space and 1 000 litres of fish tank space (as shown in Appendix 8 of this publication).
- The unit is meant for domestic food consumption only and not for small-scale income-generating production. The financial benefits can vary and might be larger than the figures shown in Table A7.4 if farmers select more profitable crops to grow. As the focus is on small-scale aquaponics for domestic food consumption, two crops have been considered in the calculations as these better reflect the production patterns of users growing food for consumption only: one leafy green (lettuce) and one fruiting vegetable (tomato).
- Yield data are obtained from a continuous production of 12 months, feeding the fish with good-quality 32 percent protein feed daily in unit water temperatures of 23–26 °C throughout the year.
- The units have a constant standing fish biomass of 10–20 kg.
- The fish cultured are tilapias. They are fed on a feeding ratio of 50 g per square metre of growing space, equivalent to a total feed consumption of 150 g per day (50 g × 3 m²). The stocking weight of juvenile fish is 50 g; the expected harvest weight is 500 g per fish in 6–8 months.
- The average yields for amateur growers have been considered in the calculations: 20 heads of lettuce per square metre per month, and 3 kg of tomatoes per square metre per month.

TABLE A7.1
Total capital costs for a media bed unit (1 000 litre fish tank and 3 m² growing space)

Item description	Price (USD)
IBC tanks*	200
Electrical equipment: water pump, air pump and connections	120
Media bed support: concrete blocks and wood planks	80
Volcanic gravel (biofiltration medium)	120
Miscellaneous items: fish net, plumber's tape (Teflon), shading material, etc.	100
Plumbing: pipe, pipe fittings and connections	80
Total	700

Notes: All items in this table are discussed, at length, in Appendix 8 of this publication.

* The life span of IBC tanks will increase if protected from the sun light with a paint coating or other material.

TABLE A7.2
Total monthly operating cost for running a small-scale aquaponic unit

System inputs	Unit	Units per month	Price per unit (USD)*	Total cost (USD)
Plants	Seedling	35	0.10	3.50
Fish	Fingerling	5	1.00	5.00
Electricity	kWh	25	0.10	2.50
Water	litre	450	0.0027	1.20
Fish feed	kg	4.5	2.50	11.25
Miscellaneous	–	1	3.00	3.00
Total costs/month				26.45

Notes:

* The figures in this column are estimated prices for each input in Israel. Simply replace these figures with locally available prices to calculate the total operating costs in another location.

Seedlings: 35 seedlings is the average reseeding rate per month for 3 m² of growing space while growing 50 % leafy greens (20 plants/m²) and 50 % fruiting vegetables (5 plants/m²).

Fingerlings: The maximum yearly production is 30 kg, which equates to 60 fish of 500 g per year. Therefore, the unit needs 60 fish per year, or about 5 fish per month.

Electricity: 30 W (water pump) + 5 W (air pump) × 24 hours × 30 days ÷ 1 000 = 25 kWh per month.

Water: On average, the water replenishment volume for a unit growing leafy greens and fruiting vegetables is about 1 % of the total water volume in the unit (1 500 litres) per day; 15 litre × 30 days = 450 litres per month.

Fish feed: 50 g (fish feed) × 3 (media beds) × 30 days = 4.5 kg per month.

Miscellaneous: The total figure of USD3 per month is an estimated price for the use of acid or base, water test kits and liquid fertilizer, if necessary.

TABLE A7.3
Expected yearly production of vegetables and fish from a small-scale aquaponic unit, including estimated yearly revenues

Output	Production (quantity)	Unit	Unit market value* (USD)	Total (USD)
Lettuce	360	head	1.20	432.00
Tomatoes	54	kg	1.60	86.40
Fish	30	kg	8.00	240.00
Total				758.40

Notes:

* Unit market values: The prices are taken from an Israeli market price comparison website (www.zap.co.il) and that of the Israeli Plants Production and Marketing Board (www.plants.org.il). Both websites accessed on 17 September 2013.

Average lettuce heads per year: 1.5 m² (50 % of growing space) × 20 heads/m² per month (1.5 × 20) = 30 heads per month. Production per year: 30 × 12 = 360 lettuce heads.

Average tomato yield per year: 1.5 m² (50 % of growing space) × 3 kg/m² of tomatoes per month (1.5 × 3) = 4.5 kg per month. Per year: 4.5 × 12 = 54 kg.

Average fish yield per year: Fingerlings stocked at 50 g of body weight. Adults harvested at 500 g after 6–8 months. Average fish stock density between 10–20 kg/m³ in the 1 000 litre fish tank. Average harvest of 5 fish per month equivalent to 2.5 kg/month, 30 kg/year.

Important: The calculations are based on a staggered production of fish in an established aquaponic system. The expected production is lower from a newly established system stocked only with juvenile fish of the same age. For new systems, it is thus suggested that fingerlings be stocked in greater numbers in order to supply enough nutrients to plants. In this case, harvesting of the first fish can start from the third or fourth month onward (with fish at 150–250 g) in order to maintain a steady biomass.

TABLE A7.4
Annual cost–benefit analysis of a media bed unit

Total costs per year	Total per year (USD)
Initial construction costs (Table A7.1)	700.00
Yearly operating costs (Table A7.2)	317.40
Yearly revenues (Table A7.3)	758.40
Yearly net profit	441.00
Payback of initial construction costs (months)	19

Taking the final figures from yearly operating costs and yearly revenues (Tables A7.2 and A7.3), the total profit is USD441 (Table A7.4). This suggests that in general, once a unit is set up, USD1.38 net profit is earned for every USD1 invested in growing food using a small-scale aquaponics unit for domestic consumption. The payback period for the initial investment is 19 months.

Reducing the capital costs (e.g. using recycled tanks) or running costs (e.g. supplementing fish feed), or increasing the revenue (e.g. specialty markets), will considerably decrease the payback period.

Appendix 8 – Step-by-step guide to constructing small-scale aquaponic systems

This step-by-step guide describes how to build the media bed, nutrient film technique (NFT) and deep water culture (DWC) systems for the small-scale aquaponic units described in Chapter 4 of this publication.

INITIAL COMMENTS ON THE THREE SYSTEM DESIGNS

The actual design theory for the three systems is explained in Chapter 4 of this publication. This appendix focuses solely on how to construct them using cheap materials that are widely available. In addition, it provides brief explanatory comments for some of the most complicated components of each system. The key factors considered for the design of each unit are: i) material cost; ii) material availability; and iii) production capacity. Thus, the materials for each design shown in the diagrams have all been selected because they are all widely accessible. The main material used for fish tanks, media beds and DWC canals is the intermediate bulk container (IBC). This is a container with a capacity of about 1 000 litres used to transport different liquids worldwide. However, for all components of each unit design, local/cheaper materials can be substituted, but the recommendations for alternative materials stated in Chapter 4 of this publication should be followed.

There are three major sections to the appendix. The first section shows how to build the media bed unit using fabricated IBC containers for the fish tank, media beds and sump tank. The second section describes how to build an NFT unit. This includes how to set up the fish tank (same as the media bed unit), how to make and install a mechanical separator and a biofilter using polyethylene barrel containers and how to install the NFT grow pipes using standard 4 inch (110 cm) PVC drainage pipe. The third and final section shows how to build the DWC unit. The same fish tank design is employed along with the same swirl clarifier and biofilter described for the NFT unit. The other parts show how to set up the DWC canals and prepare rafts using polystyrene sheets.

An index of all materials and tools used for each section is given in the following pages which should be referred to for each of the major unit construction sections.

TABLE OF CONTENTS (Appendix 8)

Index of materials	210 – 213
Index of tools	214 – 215
Media bed	217 – 226
Nutrient film technique (NFT)	227 – 238
Deep water culture (DWC)	239 – 247

INDEX OF MATERIALS

TABLE A8.1
Index of materials













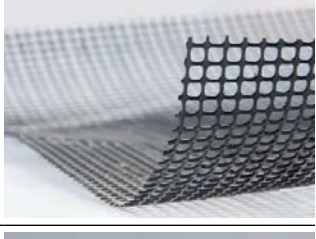

1 IBC tank		8 Ecological soap or lubricant	
2 200 litre barrel (blue)		9 Polystyrene sheet	
3 Shade material		10 Teflon (plumber's) tape	
4 Plastic netting		11 Cable ties	
5 Concrete block		12 Electric box (waterproof)	
6 Lumber (8x1 cm)		13 PVC pipe (110 mm)	
7 Submersible water pump (min. 2 000 litre/h)		14 PVC pipe (50 mm)	

TABLE A8.1 (CONTINUED)

15 PVC pipe (75 mm) with flaired end + PVC endcap (75 mm) + rubber washer (75 mm)		22 PVC adaptor (20 mm × 3/4 in) male	
16 PVC pipe (25 mm)		23 PVC elbow (25 mm × 1 in) female	
17 Polyethylene pipe (25, 20 mm)		24 PVC elbow (25 mm × 3/4 in) male	
18 Uniseal® (50, 110 mm)		25 PVC adaptor (25 mm × 3/4 in) female	
19 Sealing rubber washer (50, 110 mm)		26 PVC tap “push-on” (20 mm)	
20 PVC enlarger (40–25 mm)		27 PVC or metal tap (3/4 in) male to female	
21 PVC (25 mm × 1 in) female		28 Bucket (20 litre)	

TABLE A8.1 (CONTINUED)

29 Air pump (10 watt/h) with 2 exits		36 Net pot	
30 Air tubing		37 PVC elbow (50 mm)	
31 Plastic bottle		38 PVC coupler, straight (50 mm)	
32 Air stone		39 PVC connector, T (50 mm)	
33 Fish net		40 PVC endcap/ stopper (50 mm)	
34 Biofilter medium (Bioball® or bottle caps)		41 PVC elbow (110 mm)	
35 Gravel, volcanic (8–20 mm)		42 PVC connector, T (110 mm)	

TABLE A8.1 (CONTINUED)

43 PVC coupler, straight (110 mm)		50 PVC connector, T "push-on" (20 Mm)	
44 PVC reducer (110–50 mm)		51 PVC endcap/stopper (110 mm)	
45 PVC barrel connector, B-type (1 in)		52 PVC adaptor (25 mm x 3/4 in)	
46 PVC barrel connector, V-type (1 in)		53 PVC connector, T (25 mm x 1 in) female	
47 PVC or metal tap (1 in) male to female		54 PVC elbow (25 mm)	
48 PVC elbow "push-on" (20 mm)		55 PVC connector, T (25 mm)	
49 PVC elbow (25 mm x 3/4 in) female		56 PVC elbow (25 mm x 1 in) male	
		57 PVC connector, T (25 x 3/4 in) female	

INDEX OF TOOLSTABLE A8.2
Index of tools

1 Ear protection		6 Pipe wrench	
2 Work gloves		7 Saw	
3 Safety goggles		8 Hammer	
4 Spirit level		9 Pliers	
5 Measuring tape		10 Screw driver	

TABLE A8.2 (CONTINUED)

11 Electric drill		15 Marker	
12 Conical drill (0–1 in)		16 Circular drill bit (hole saw)	
13 Jigsaw		17 Angle grinder	
14 Knife		18 Star-headed key	

SECTION 1 – THE MEDIA BED UNIT

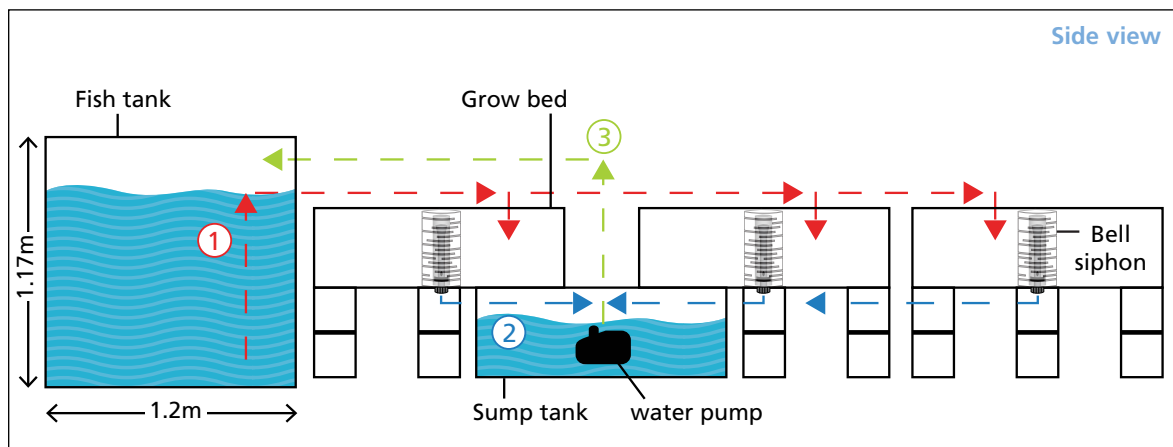
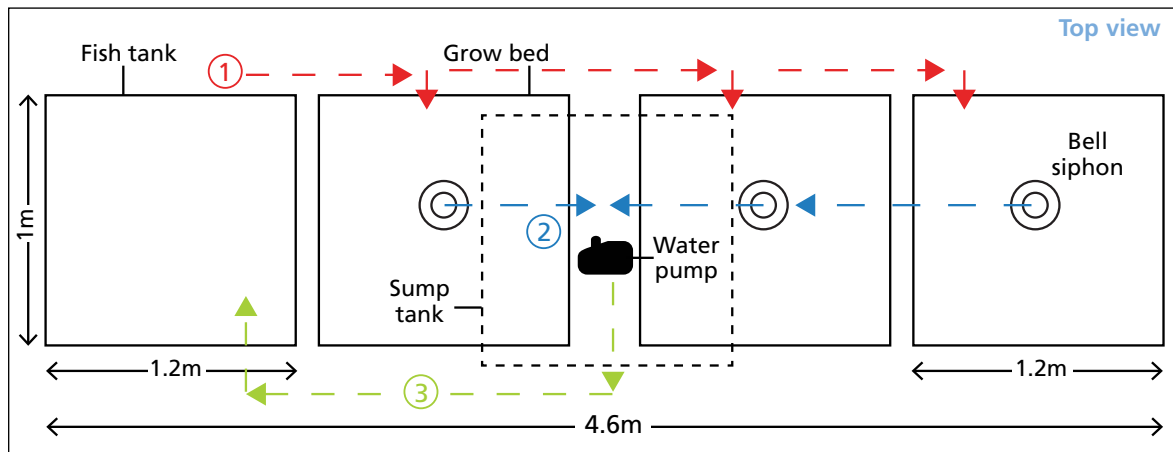

Water flow diagram

- ① Water flows by gravitation from the fish tank to the media beds.
- ② Water flows from the media bed into the sump tank.
- ③ Water flows back to the fish tank from the sump by using the water pump.

TABLE A8.3
List of items for the media bed unit

	Item name	Item No. from Table A8.1	Quantity
1	IBC tanks	1	3
2	Submersible water pump (MIN. 2 000 litres/h)	7	1
3	Air pump (10 watt/h) with 2 exits	29	1
4	Air tubing	30	3 m
5	Air stone	32	2
6	Concrete block	5	48
7	Lumber (8×1 cm)	6	21 m
8	Gravel, volcanic (4–20 mm)	35	750 litre
9	Shade material	3	2 m ²
10	Teflon (plumber's) tape	10	1 roll
11	Cable tie	11	15
12	Electric box (waterproof)	12	1
13	Ecological soap or lubricant	8	1
14	Plastic bottle	31	1
PVC PIPE AND FITTINGS			
15	PVC pipe (50 mm)	14	7.5 m
16	Sealing rubber washer (50 mm)	19	1
17	PVC elbow (50 mm)	37	5
18	PVC coupler, straight (50 mm)	38	6
19	PVC connector, T (50 mm)	39	2
20	PVC endcap/stopper (50 mm)	40	4
21	PVC barrel connector, B-type (1 in)	45	3
22	PVC or metal tap (1 in) male to female	47	3
23	Uniseal [®] (50 mm)	18	1
BELL SIPHON			
24	PVC pipe (110 mm)	13	0.9 m
25	PVC pipe (75 mm) with flaired end + PVC endcap (75 mm) + rubber washer (75 mm)	15	3
26	PVC pipe (25 mm)	16	0.8 m
27	PVC barrel connector, V-type (1 in)	46	3
28	PVC enlarger (40–25 mm)	20	3
29	PVC (25 mm × 1 in) female	21	3
30	PVC elbow (25 mm × 1 in) female	23	3
31	Polyethylene pipe (25, 20 mm)	17	9 m

1. PREPARING THE FISH TANK

1.1 – Remove the two horizontal steel lengths attached to the top surface of the IBC tank holding the inner plastic container in place. The steel lengths are fixed with 4 star-headed screws. Remove these four screws (Figure 1) using a star headed screwdriver (Figure 2) or star-headed key (Figure 3). Once the steel lengths are removed, pull out the inner plastic tank

If there is no star key, cut the screws with an angle grinder.



1.2 – After pulling out the tank, draw a rough square shape on the top surface of the tank 5 cm from the 4 sides of the tank (Figure 4). Then, using the angle grinder (Figure 5), cut along the square shape and remove the cut piece from the top (Figure 6). Once removed, wash the inside of the container thoroughly with soap and warm water and leave to dry for 24 hours (Figure 7).

The cut piece removed can be used as the fish tank cover.

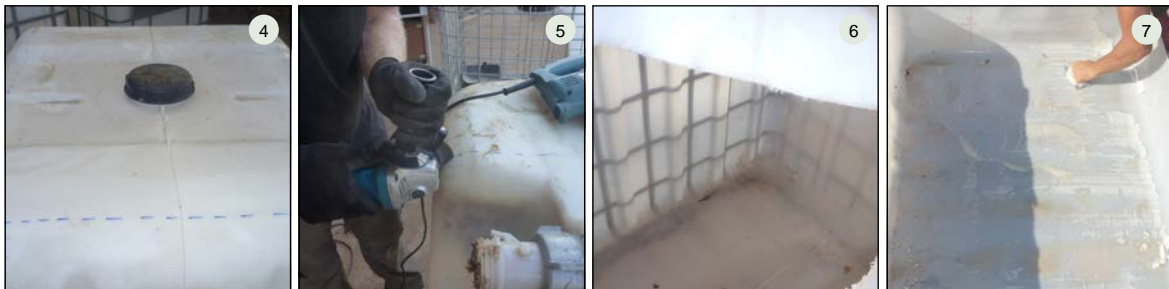

2. INSTALLING THE FISH TANK EXIT PIPE

2.1 – On one side of the IBC tank, mark a point 12 cm from the top and 12 cm from the side of the tank (Figure 8), and drill a hole at that point using the 57 mm circular drill bit (Figure 9). Insert a 50 mm uniseal (Figure 10) inside this hole.

Attention: the circular drill bit size should be 57 mm and not 50 mm (see Figure 8).



2.2 – The fish tank exit pipe is made of 2 lengths of PVC pipe (50 mm) combined using a PVC elbow (50 mm) and PVC coupler/straight connector (50 mm) (Figure 11). The length of PVC (50 mm) along the bottom surface of the tank is cut with horizontal slits 2–3 mm wide by using the angle grinder (Figure 12) to allow solid waste to enter the pipe but to prevent fish from doing so. The open end of the PVC length along the

bottom surface of the fish tank is sealed with a PVC endcap/stopper (50 mm). Slot a short length of PVC (50 mm) through the uniseal (50 mm) and attach to a PVC elbow (50 mm) on the inside end (Figure 11) and then attach the other (vertical) pipe length to the elbow that is now connected to the uniseal (50 mm). Finally, drill a 2–3 cm diameter hole into the PVC elbow (50 mm) attached to the uniseal (50 mm) (Figure 13). This small hole prevents any air seal forming inside the pipe, which would drain all the water out of the fish tank in the event of power cut or if the pump stopped working. This is also called an accidental siphon. This step is not optional.



3. PREPARING THE MEDIA BEDS AND SUMP TANK

To make the 3 media beds and 1 sump tank, the 2 other IBC tanks are needed: the first to make the sump tank and 1 media bed, and the second to make the two remaining media beds. Take the 2 IBC tanks and remove the 4 steel profiles and pull out the plastic containers as shown before in Figures 1–3.

4. MAKING TWO MEDIA BEDS FROM ONE IBC

First, stand the plastic inner container upright (Figure 14) and mark, using a metre stick and pencil, two bisecting lines 30 cm from both sides of the tank (as seen in Figure 15). Make sure to mark the exact lines (shown in the Figure 15). Take the angle grinder and carefully cut along both bisecting lines marked out to create two uniform containers with a depth of 30 cm (Figure 16). Then, take both containers and wash them thoroughly using natural soap and warm water and leave them out to dry in the sun for 24 hours.



5. METAL SUPPORTS FOR BOTH MEDIA BEDS

5.1 – Take the IBC metal support frame and cut out two support frames by following the same bisecting lines shown in Figure 14 using the angle grinder (Figure 17). When cutting the two 30 cm sides of the support frame, make sure to keep the two horizontal steel profiles intact as they will provide excellent support to the sides of the beds once they are full of water and medium (Figure 18).



5.2 – Then, take both support frames and lay them out on the floor. Take the wood lengths (4 lengths of 104 cm, 1 length of 42 cm and 1 length of 48 cm) and place them on top of the support frame as shown in Figure 19. These wood lengths keep the media bed horizontal, which is vital for the functioning of the bell siphons. Next, take the washed media beds and place them on top of the support frame and wood lengths (Figure 20). Finally slot in the remaining wood lengths in between the plastic media bed and support frame on both sides of each bed to provide further support (Figure 21).



6. MAKING A SUMP TANK AND ONE MEDIA BED FROM AN IBC

6.1 – Take the remaining IBC, place it upright and mark out, using a metre stick and pencil, only one 30 cm bisecting line as seen in Figure 22. Then, take the angle grinder and cut the inner plastic container and metal support frame at once by following the bisecting line (see Figure 22). Remove the 30 cm container (third media bed) from the remaining 70 cm container (sump tank) (Figure 23). Wash out both containers thoroughly with natural soap and warm water and leave in the sun for 24 hours.

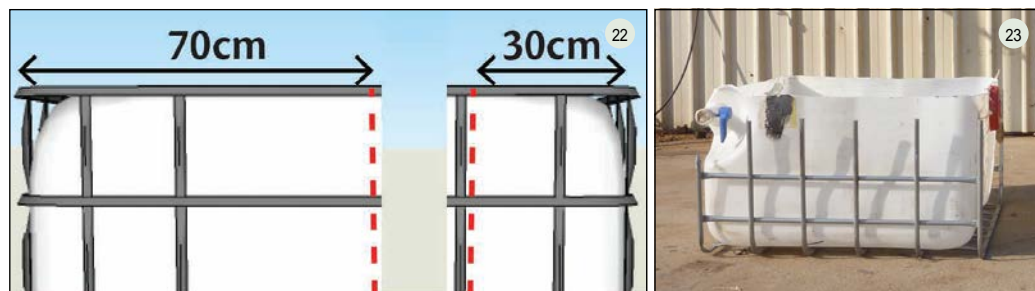

6.2 – For the third media bed, follow the same steps regarding the wood lengths as detailed above for the first two. Finally, take the sump tank container and drill two holes (25 mm diameter) using the conical drill bit as shown in (Figure 25) (25 mm pipes will be inserted into both of these holes later, the pipes will drain water from each media bed).

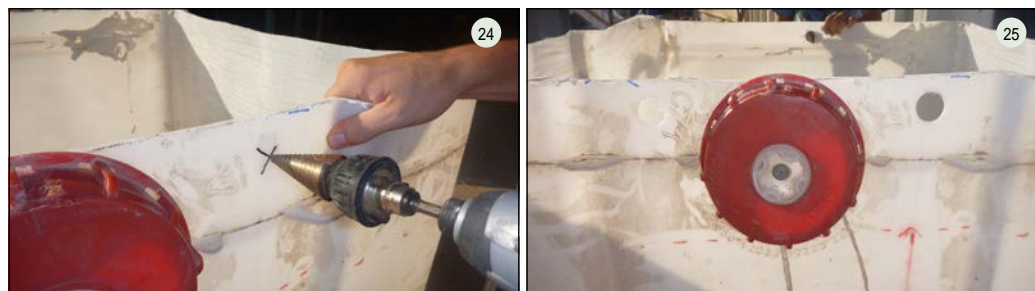

7. PREPARING THE BELL SIPHONS

As explained in Chapter 4 of this publication, bell siphons are simple mechanisms used to automatically flood and drain each media bed. The following materials are needed to make one siphon, so 3 of each are needed in total:

- 35 cm media guard (110 mm PVC pipe)
- 27 cm bell [PVC pipe (75 mm) with flaired end + endcap/stopper (75 mm) + rubber washer (75 mm)]
- 16 cm standpipe (25 mm PVC pipe)
- Barrel connector (25 mm)
- PVC reducer (40–25 mm)
- PVC female adaptor (25 mm × 1 inch)
- PVC elbow (25 mm × 1 inch female)

7.1 – First, create the bell. Take a 27 cm section of PVC (75 mm) and cut out 2 pieces as shown in Figure 26 using the angle grinder. Then, drill a hole (10 mm in diameter) using a drill bit about 1.5 cm from the two cut pieces as shown in Figure 26. Finally, seal one end of the bell using the PVC endcap/stopper (75 mm) and rubber washer (75 mm).

7.2 – Next, make the media guards from the 35 cm length of PVC pipe (110 mm) and cut 5 mm slots along their entire length using the angle grinder (Figure 27).

7.3 – Now, take each media bed and mark their centre points in-between the two wooden lengths below as shown in Figure 28. Drill a hole (25 mm in diameter) at each centre point (Figure 29) and insert the barrel connector (25 mm) with the rubber washer placed inside the media bed. Tighten both sides of the barrel connector using a wrench (Figure 30).

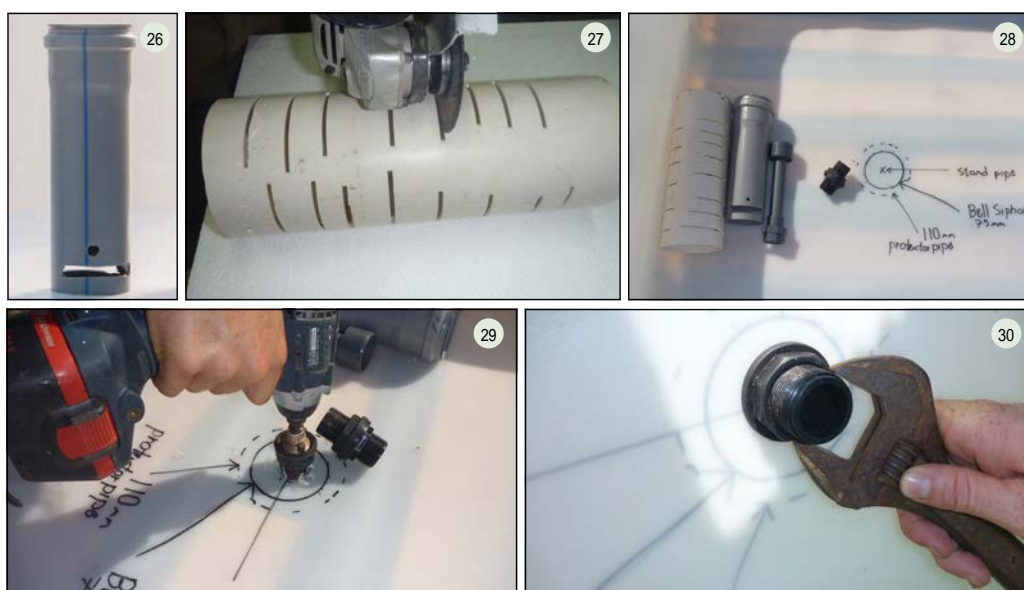

7.4 – Screw the PVC adaptor (1 inch – 25 mm) onto the barrel connector (25 mm) inside the media bed and then slot the standpipe into the PVC adaptor (1 inch – 25 mm). After, attach the second PVC adaptor (25–40 mm) to the top of the standpipe (Figures 31–33). The purpose of this adapter is to allow a larger volume of water to initially flow down

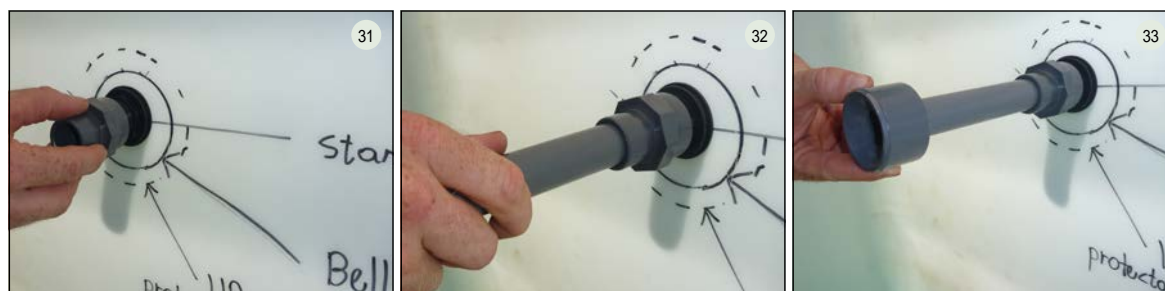

the standpipe when the water has reached the top. This helps the siphon mechanism to begin draining the water out into the sump tank.

7.5 – Place the bell siphons and the media guards over the standpipes (Figures 34–36).



7.6 – Finally, connect the PVC elbow (1 inch–25 mm) to the other end of the barrel connector underneath the media bed, which allows the water to flow out of the media bed (Figures 37–39).



8. ASSEMBLING THE MEDIA BEDS AND SUMP TANK

8.1 – First, place the sump tank and brace it with six concrete blocks from each side (12 blocks in total) as shown in Figures 40 and 41. Make sure the blocks do not cover the holes already drilled into the sump tank (Figure 42).



8.2 – Place the remaining blocks and the fish tank according to the distances described in Figure 43. The fish tank should be raised up about 15 cm from the ground. This can be done by using concrete blocks as shown in Figure 43. Place the three media beds (including the metal support frames and wood lengths) on top of the blocks (as shown in Figure 44). Make sure the grow beds are secured on top of the blocks and horizontal by verifying with a spirit level. If not, slightly adjust the layout of the blocks underneath.



9. PLUMBING THE UNIT: FISH TANK TO THE MEDIA BEDS (DISTRIBUTION MANIFOLD)

9.1 – The plumbing parts needed for this section are as follows:

- Barrel connector, B-type (1 inch) × 3
- PVC tap (1 inch) × 3
- PVC endcap/stopper (50 mm) × 3
- PVC elbow (50 mm) × 2
- PVC connector, T (50 mm) × 2
- PVC coupler (50 mm) × 3
- 150 cm of PVC pipe (50 mm) × 1
- 85 cm of PVC pipe (50 mm) × 1

9.2 – Go back to the “preparing the fish tank” (2.2) instructions. The last instruction shows a length of PVC (50 mm) slotted through the uniseal (50 mm) and exiting the fish tank. Take another PVC elbow (50 mm) and connect it to the pipe slotted through the uniseal (Figure 45). Then, using a PVC straight coupler (50 mm) and another PVC elbow (50 mm), connect the fish exit pipe to the distribution pipe (50 mm) at the same height as the top of the media bed (Figure 46).

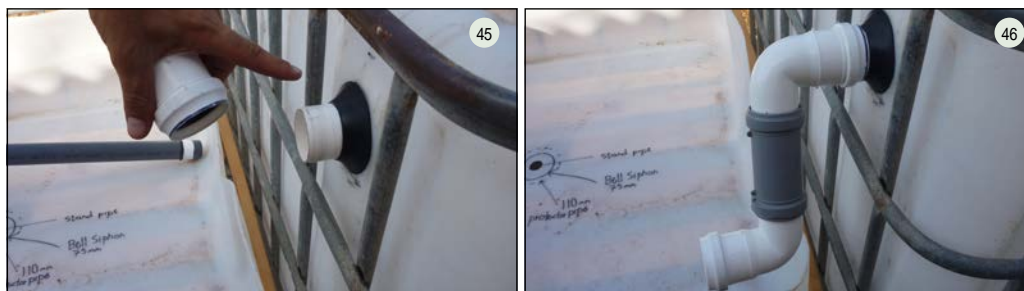

9.3 – On each media bed, a valve is used to control the water flow entering the bed. To include a valve, first take a PVC endcap/stopper (50 mm) and drill a hole (25 mm diameter). Insert a barrel connector (25 mm) into the hole and tighten both ends using a wrench. Then, wrap Teflon tape around the threads of the male end of the barrel connector and screw the tap valve (1 inch) onto the barrel connector (Figures 47–50). There is one valve for each media bed for a total of three valves.



9.4 – From the PVC elbow (50 mm) attached to the fish exit pipe, follow the pipe layout shown in Figure 51 that allows water to flow into each media bed. Materials include: PVC pipe (50 mm), PVC elbow (50 mm) and PVC T-connector (50 mm). Next, attach the pipe caps fitted with the valves to the PVC T connectors and PVC elbow connectors from the distribution pipe as in Figure 51, using one for each media bed. Use a PVC straight coupler (50 mm) if necessary.



10. PLUMBING THE UNIT: MEDIA BEDS TO THE SUMP TANK (DRAIN PIPE)

10.1 – Figures 52 and 53 show the media beds marked as A, B and C. For media bed A, attach a drain pipe of 60 cm length of PVC pipe (25 mm) to the elbow connection underneath the media bed (Figure 54), which exits from the bottom of the bell siphon standpipe. Next, slot the 60 cm length of pipe into the closest drilled hole on the side of the sump tank allowing the water to flow directly into the sump.

10.2 – Attaching media beds B and C (Figure 53): Under media bed C: attach a PVC elbow connector (25 mm to 1 inch) to the end of the barrel connector (Figure 54). Then, take a 2 metre length of polyethylene pipe (25 mm) and attach it to the drilled holes at the side of the sump tank (Figure 53 and 55).

10.3 – Do the same with media bed B using 1 metre of polyethylene pipe (25 mm) (Figure 55). Now, the water exiting media beds B and C will flow through separate polyethylene pipes (25 mm) into the sump tank.

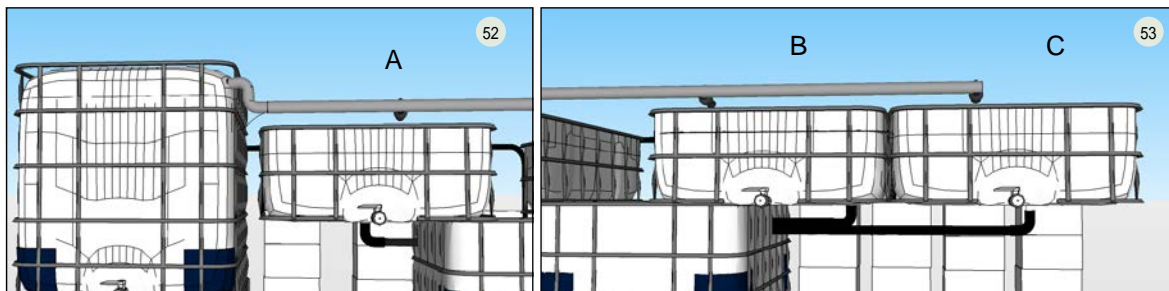

Finally, it is advisable to fix the pipes underneath the beds to the metal frame using cable ties to relieve any pressure on the pipe fittings (Figure 54).



11. PLUMBING THE UNIT: SUMP TANK TO THE FISH TANK

11.1 – Take the submersible pump and attach a polyethylene pipe (25 mm) using a PVC straight connector (1 inch – 25 mm), or any other connector that can attach the specific pump to the 25 mm pipe (Figure 56). Take a length of the polyethylene pipe (25 mm) that is long enough to reach the inside of the fish tank from the submersible pump (Figure 57). Attach one end to the submersible pump and the other into the top of the fish tank (see Figure 57–60). It is recommended to use the fewest connectors, especially elbows, between the pump and fish tank which will decrease pumping capacity.

11.2 – Place the electric box in a safe place higher than the water level and shaded from direct sunlight. Make sure it is still waterproof after plugging in the water and air pump plugs (Figure 61).



12. ADDING THE MEDIUM AND RUNNING THE UNIT

12.1 – All parts of the system are now in place except for the growing medium (volcanic gravel) in the beds. Yet before the media is added, it is recommended to fill the fish tank and sump tank with water and run the pump to check for any leaks in the system. While checking for leaks, remove the standpipe and bell siphon so the water flows straight into the sump tank. If leaks appear, fix them immediately where they arise by tightening the plumbing connections, re-applying Teflon to the treaded connections and making sure all taps are in their ideal position (Figures 62–67).

12.2 – Once all the leaks are fixed and the water is flowing smoothly through all components of the unit, re-assemble the siphon bell and standpipes fill the beds with medium to a depth of 30 cm (Figures 68–69)





SECTION 2 – THE NUTRIENT FILM TECHNIQUE (NFT) UNIT

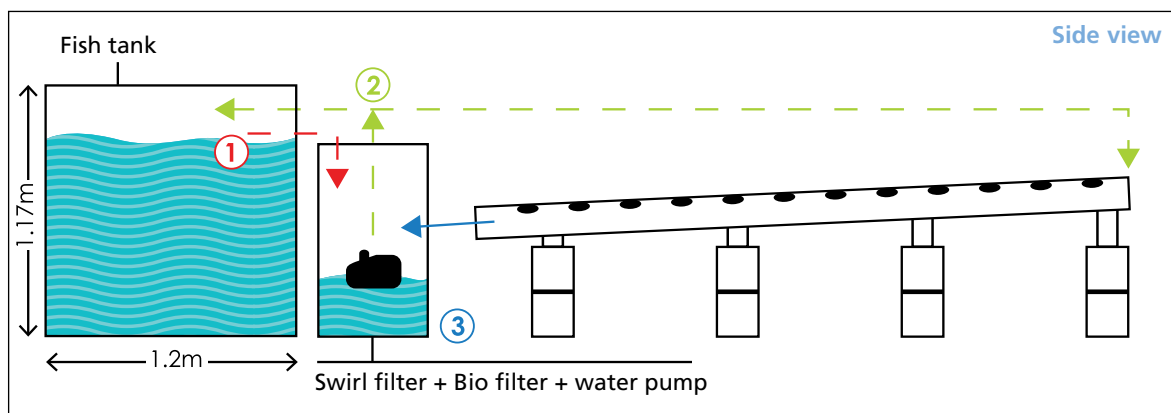
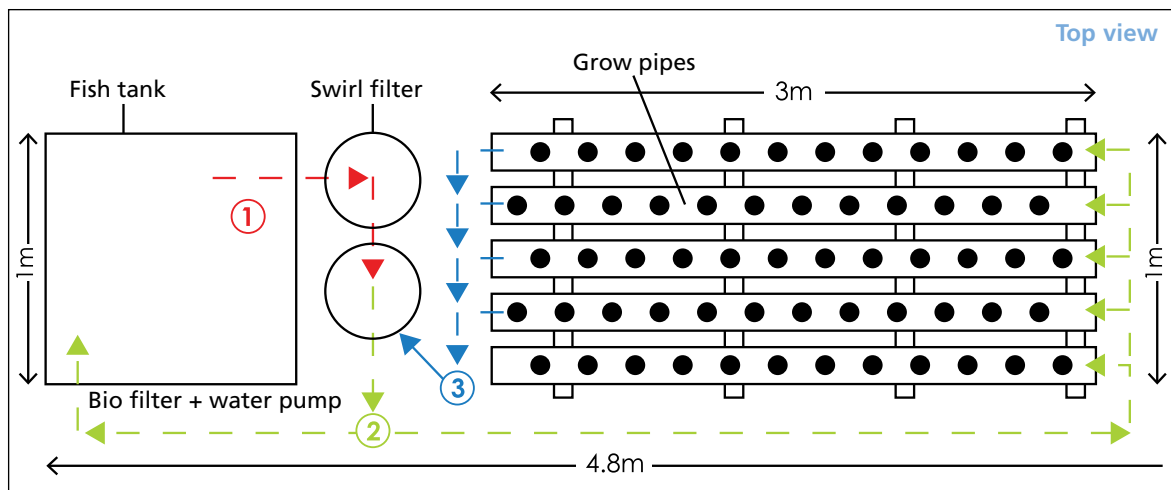
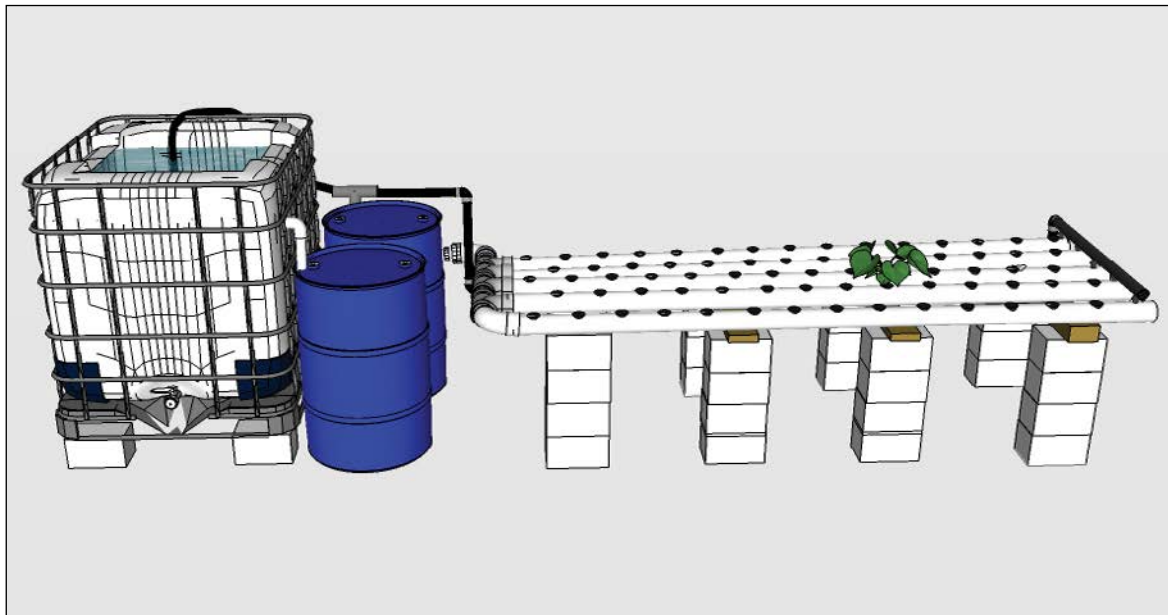

Water flow diagram

- ① Water flows by gravitation from the fish tank to the swirl filter and biofilter.
- ② Water is pumped, using the submersible pump, from the biofilter to the fish tank (80% of the flow) and the DWC canals (20% of the flow).
- ③ Water flows back from the canals to the biofilter.

TABLE A8.4
List of items for the NFT unit

	Item name	Item No. from Table A8.1	Quantity
1	IBC tank	1	1
2	Bucket (20 litre)	28	1
3	200 litre barrel (blue)	2	2
4	Biofilter medium (Bioball or bottle caps)	34	40–80 litres
5	Submersible water pump (min. 2 000 litres/h)	7	1
6	Air pump (10 watt/hour) with 2 exits	29	1
7	Air tubing	30	3 m
8	Air stone	32	2
9	Concrete block	5	32
10	Lumber (8×1 cm)	6	8 m
11	Shade material	3	2 m ²
12	Fish net	33	1
13	Teflon (plumber's) tape	10	1
14	Cable tie	11	25
15	Electric box (waterproof)	12	1
16	Net pot	36	80
17	Gravel, volcanic (4–20 mm)	35	30 litres
18	Ecological soap or lubricant	8	1
PVC PIPES AND FITTINGS			
19	PVC pipe (110 mm)	13	16 m
20	PVC connector, T (110 mm)	42	4
21	PVC elbow (110 mm)	41	2
22	PVC coupler, straight (110 mm)	43	1
23	PVC endcap/stopper (110 mm)	51	5
24	PVC reducer (110–50 mm)	44	1
25	Sealing rubber washer (110 mm)	19	20
26	PVC pipe (50 mm)	15	5 m
27	Uniseal [®] (50 mm)	18	5
28	PVC elbow (50 mm)	37	6
29	PVC coupler, straight (50 mm)	38	4
30	PVC endcap/stopper (50 mm)	40	1
31	Sealing rubber washer (50 mm)	19	8
32	Polyethylene pipe (25 mm)	17	8 m
33	PVC connector, T (25 mm)	55	2
34	PVC elbow (25 mm × ¾ in) female	49	2
35	PVC adaptor (20 mm × ¾ in) male	22	1
36	Polyethylene pipe (20 mm)	17	2 m
37	PVC connector, T “push-on” (20 mm)	50	4
38	PVC elbow “push-on” (20 mm)	48	1
39	PVC tap “push on” (20 mm)	26	5

1. PREPARING THE FISH TANK (SAME AS IN MEDIA BED UNIT, SECTIONS 1–2)

2. PREPARING THE MECHANICAL SEPARATOR AND BIOFILTER

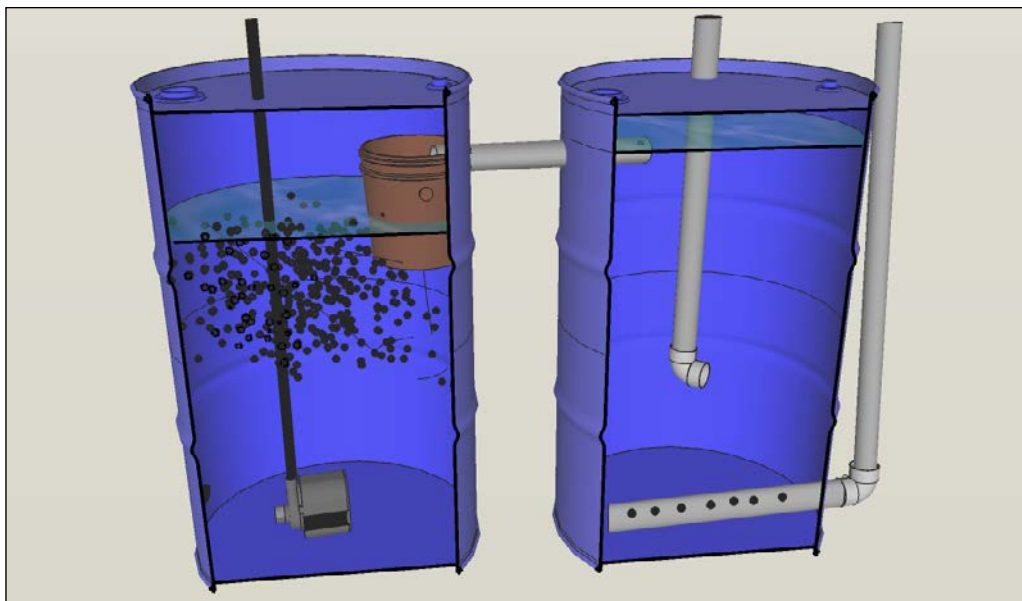

2.1 – Take two blue barrels (200 litre) (Figure 1) and cut out the shapes marked in the figures below (Figures 2–4) using the angle grinder. Afterwards, wash both barrels with soap and warm water thoroughly and leave to dry in the sun for 24 hours.



2.2 – The cut pieces of both barrels can also be used as barrel covers. They can be fixed to the top of the barrel using cable ties (see Figures 5–6).

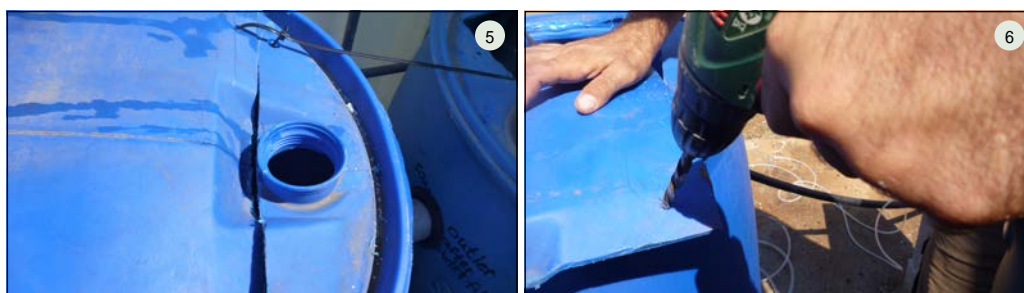

3. BARREL No. 1 – MECHANICAL SEPARATOR

Inlet / outlet pipes of the mechanical separator

- A. Inlet pipe from the fish tank.
- B. Drainage pipe at the bottom of the mechanical separator.
- C. Outlet pipe into the biofilter.

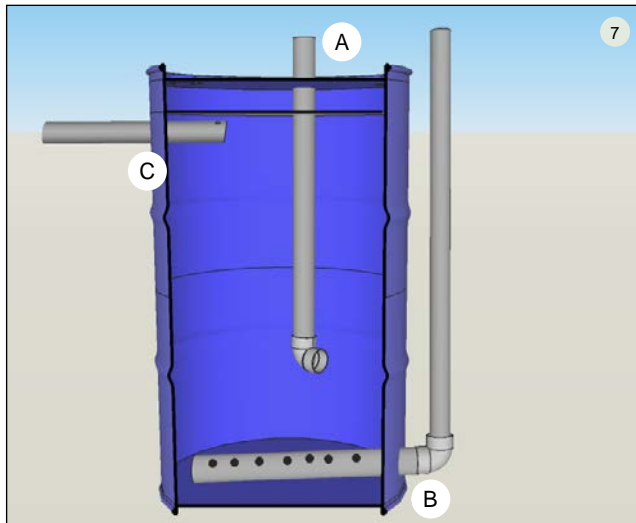

Inlet pipe from the fish tank

3.1 – Drill a hole (50 mm) using the 50 mm circular drill bit at the top surface of the barrel and slide in the fish tank exit pipe (Figures 8–9).

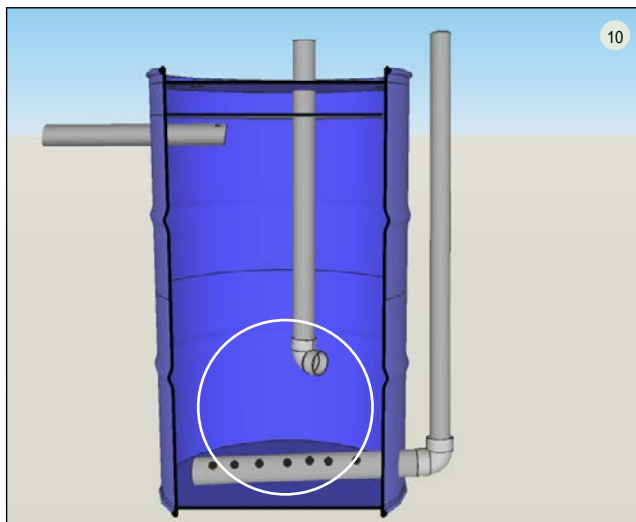

3.2 – Extend the exit pipe of the fish tank to 30 cm above the bottom of the mechanical separator container. Attach a PVC elbow (50 mm) to the bottom of the exit pipe so the water flows tangentially to the container forcing the water to circulate (Figure 10).

Drainage pipe at the bottom of the mechanical separator

3.3 – Next, take a length of PVC pipe (50 mm) and cut 2–3 mm horizontal slits along the entire length using the angle grinder (Figure 11). Drill a hole (57 mm) on the outside of the barrel, 5 cm above the bottom, and insert a uniseal (50 mm) (Figure 12). Slide the drain pipe (50 mm PVC pipe cut with slits) through the uniseal and connect a PVC elbow (50 mm) to the end of the pipe outside the barrel. Finally, attach another PVC pipe (50 mm) that is 60–70 cm in length to the elbow and make sure that the end of the pipe is above the maximum water level of the barrel (Figure 13). The slits on the drainage pipe will allow solid waste to enter it and be flushed out by reclining the other vertical pipe attached outside of the barrel and pouring out the water from its end.



Transfer pipe connecting the mechanical separator to the biofilter

3.4 – Take a 65 cm length of PVC pipe (50 mm) and cut the same horizontal slits as above (3.3) for only the first 25 cm of the pipe using the angle grinder (Figure 14). Seal the slotted end of the pipe (50 mm) using a PVC endcap/stopper (50 mm). Next, drill a hole (57 mm) with the 57 mm circular drill bit 70 cm from the bottom of the barrel, and insert a uniseal inside the hole. Slot the transfer pipe (50 mm) through the uniseal, making sure the end with 25 cm slits is completely inside the mechanical separator barrel (Figures 15–16).



4. BARREL No. 2 – BIOFILTER Inlet/outlet pipes of the biofilter

- A. Inlet pipe from the mechanical separator (Figure 17).
- B. Water outlet from the water pump.
- C. Drainage tap.

25 mm drain tap

4.1 – Drill a hole (25 mm) at the very bottom of the biofilter barrel and insert a barrel connector (V type, 25 mm) into the hole and fasten it tight. Attach a tap (25 mm) to the barrel connector on the outside of the barrel making sure the connector is wrapped with Teflon to make a water tight seal (Figure 18). The tap is used to flush out any solid waste accumulating at the bottom of the biofilter container.

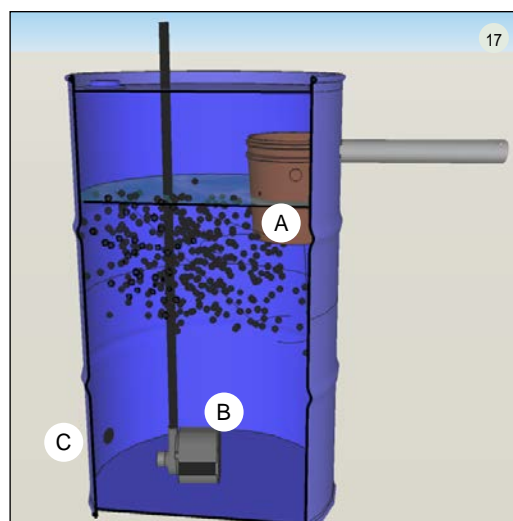

Inlet pipe from the mechanical separator

4.2 – Drill a hole (57 mm) using the 57 mm circular drill bit 70 cm from the bottom of the barrel and insert a uniseal in the hole (Figure 19). Place the biofilter barrel adjacent to the mechanical separator barrel. Take the 65 cm PVC pipe length already attached to the mechanical separator barrel and slot it through the uniseal in the biofilter barrel as well. Now, both barrels are joined together using this transfer pipe (Figure 20).



Preparing the solids capture bucket

4.3 – Drill a 50 mm hole in the 20 litre bucket 5 cm below the top rim of the bucket (Figure 21)

4.4 – Drill at least 20 holes (8 mm diameter) into the bottom of the bucket using an 8 mm drill bit to allow water to drain into the biofilter (Figure 21).



4.5 – Insert and slide the bucket along the 65 cm transfer pipe inside the biofilter (the same 65 cm pipe that connects both filter barrels (Figures 22–23)

4.6 – Drill a 20 mm hole into the transfer pipe and insert 6–10 cm of PVC (20 mm) (Figure 23) to prevent the solids capture bucket from sliding off the transfer pipe.



4.7 – Place filtration media (in this configuration we use volcanic gravel but perlite, sponge or other filters may be utilized) inside the bucket to capture any remaining solid or suspended waste (Figure 24).



4.8 – Fill the biofilter with biofilter medium (Bioballs or bottle caps)

5. POSITIONING THE NFT PIPES

The materials needs for this section are as follows:

- 48 concrete blocks
- 1 m wood length (30 mm thick) × 1
- 1 m wood length (20 mm thick) × 1
- 1 m wood length (10 mm thick) × 1

5.1 – Place the concrete blocks according to the distances in Figure 25. Each stand is made of 8 blocks (two columns, each column 4 blocks high. Place the wood lengths on



to the blocks: place the 3 cm thickness length along the column of blocks furthest away from the tank, the 2 cm thickness length on the middle columns and the 1 cm thickness length on the closest columns. This arrangement will create a small slope allowing the water to easily flow through the pipes and return to the biofilter barrel (Figure 25).

6. CONNECTING THE NFT PIPES AND COMMUNAL DRAIN

The materials needs for this section are as follows:

- 3 m of PVC pipe (110 mm) × 5
- PVC elbow (110 mm) × 2
- PVC T connector (110 mm) × 4
- PVC endcap/stopper (110 mm) × 5
- Rubber washer (110 mm) × 15
- Natural soap

6.1 – Connect the pipe system according to Figure 27. Make sure that each pipe and pipe fitting has a lubricated rubber seal fitted inside using the natural soap as a lubricant (Figure 26).



7. MARKING THE PLANT HOLES

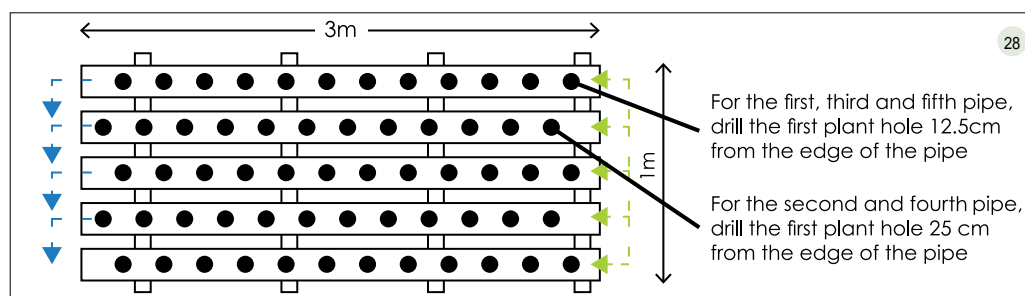

7.1 – Place the NFT pipes on top of the blocks and wood lengths and fit the five end caps (110 mm) to the ends of the pipe furthest from the fish tank (Figure 30). One effective method for marking the plant holes is to stretch and secure a thin piece of rope along the top of each pipe to mark uniform distances accurately.

7.2 – Mark a point every 25 cm along the rope (Figure 29) which will be the centre point for the holes. Drill the holes (Figure 33) according to the size of the net pots.

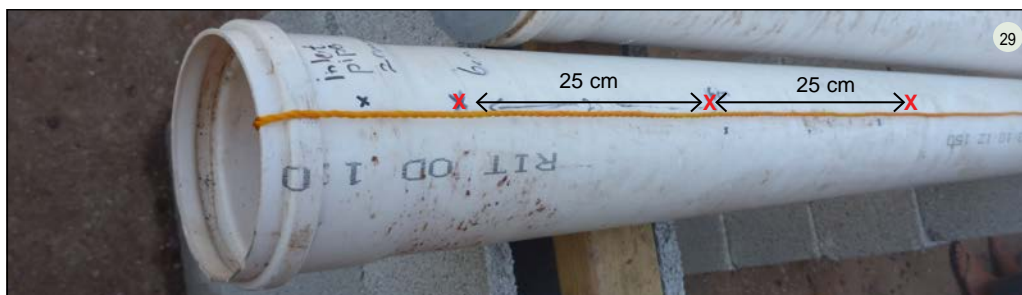

For optimal plant growing space, follow the triangular pattern shown in Figures 28 and 31.

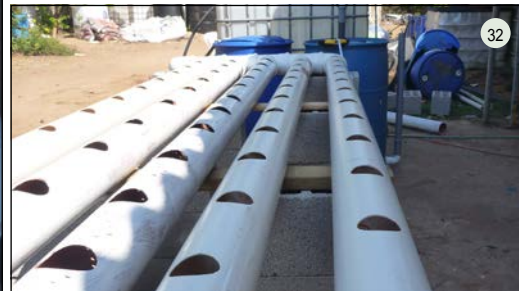
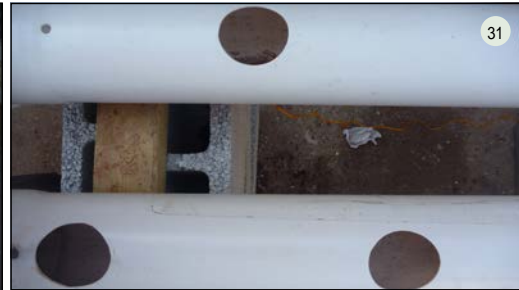

7.3 – Finally, drill 20 mm holes, 7 cm from the ends of the pipe farthest from the fish tank to allow water to enter the NFT pipes (Figure 34).

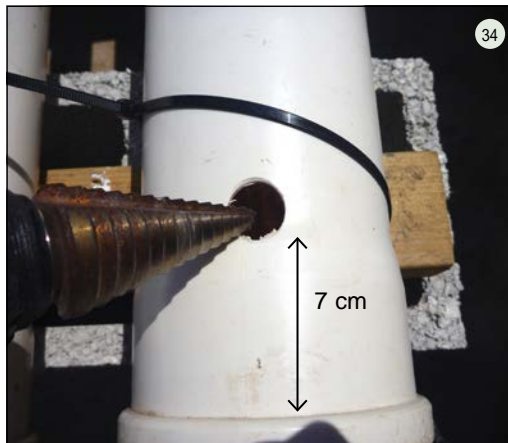

7.4 – Secure the NFT pipes to the wood length using plastic cable ties (Figure 35).

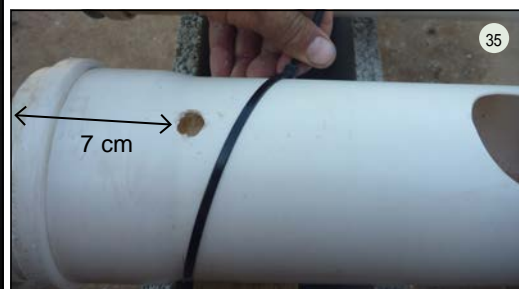

8. CONNECTING THE END OF THE GROW PIPES BACK TO THE BIOFILTER

8.1 – Take a PVC straight coupler/connector (110 mm) and attach it to the final PVC elbow (110 mm) of the common gutter of the NFT pipes (Figure 27), which is made with a series of PVC T connections (110 mm). Then, attach a PVC reducer (110–50 mm) to the PVC straight coupler/connector (110 mm). This communal drain must connect to the biofilter. Drill a 50 mm hole on the outside of the biofilter, 10 cm lower than the bottom of the grow pipes. Fit a PVC elbow (50 mm) into this hole. Use PVC pipe (50 mm) to connect the elbow (50 mm) to the reducer (110–50 mm) allowing the water to flow from the NFT pipes back into the biofilter barrel. (Figures 36–38).

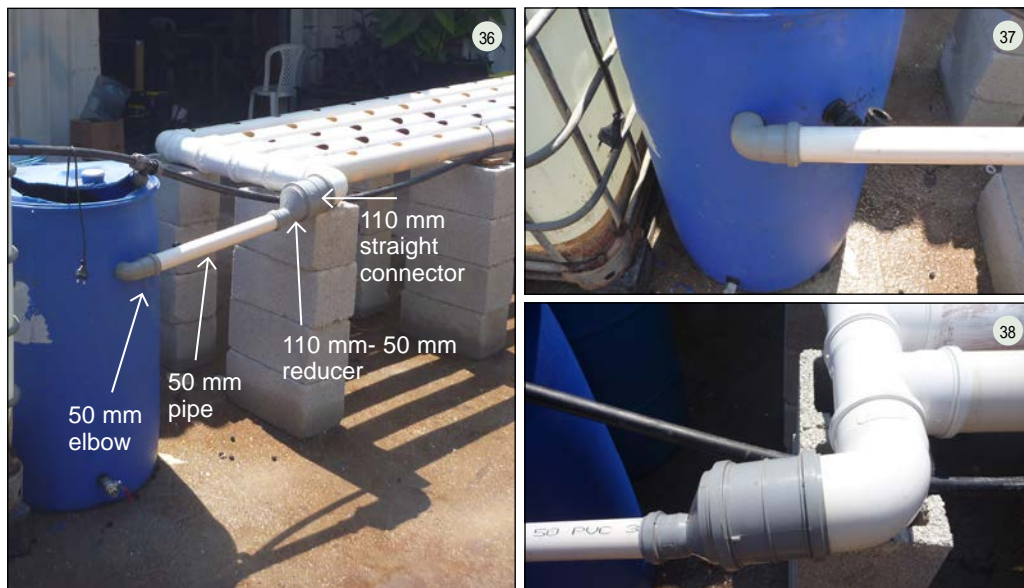

9. INSTALLING THE DISTRIBUTION PIPING FOR EACH NFT PIPE

The materials needs for this section are as follows:

- PVC “push on” taps (20 mm) × 5
- PVC “push on” T connectors (20 mm) × 4
- PVC “push on” elbow connectors (20 mm) × 2
- Polyethylene pipe (20 mm)
- PVC adapter (20 mm – ¾ inch × 1)
- PVC elbow female connector (25 mm – ¾ inch) × 1
- Plumber’s tape (Teflon)

9.1 – Connect all of the pipe and fittings according to Figures 39 and 40.



10. ADDING THE SUBMERSIBLE PUMP

10.1 – For this unit, the submersible pump is placed at the bottom of the biofilter barrel (Figures 41a and 41b). Water is pumped from there to two locations: the NFT pipes and the fish tank. 80–90 percent of the water flows to the fish tank while 10–20 percent flows into the NFT pipes. The taps are used to control the water flow at each location.



11. PUMPING TO THE FISH TANK

11.1 – Connect the submersible pump to a length of polyethylene pipe (25 mm) using a PVC adaptor, female (25 mm – 1 inch), or any connection that fits the pump. The polyethylene pipe (25 mm) should be at least 1 m long. Place a PVC T connection (25 mm) at the end of the pipe to allow water to flow to the fish tank and the NFT pipes (Figures 42–43).



11.2 – Attach a PVC pipe (25 mm) to one end of the T connection (Figure 42) long enough to reach the fish tank (Figure 44). Use a flexible pipe, if possible, to remove the need for additional connectors, which would reduce the pumping capacity of the pump. Attach a tap (25 mm) to the end of the pipe to control the incoming water flow into the fish tank (Figure 44).

11.3 – Next, take about 4 metres of PVC pipe (25 mm) and attach to the other end of the PVC T connector (25 mm) coming from the water pump pipe inside the biofilter. Attach this pipe (25 mm) to the distribution manifold through the PVC elbow female connector (25 mm – 3/4 inch) seen in Figure 40, which will supply water to each NFT pipe (Figure 44).

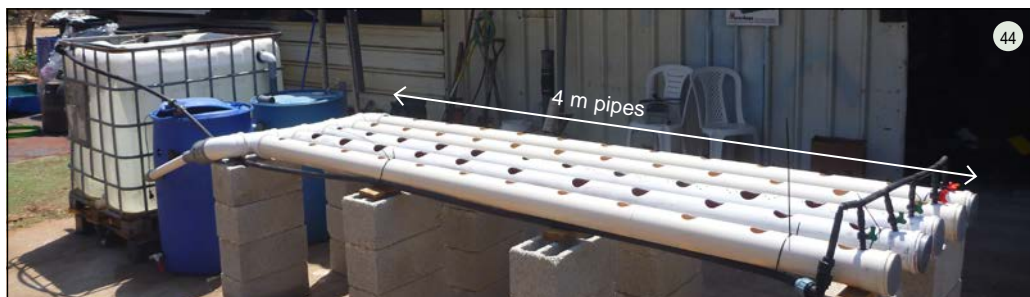

12. ELECTRIC BOX + AIR PUMP

12.1 – Place the electric box in a safe place higher than the water level and shaded from direct sunlight (Figure 45). Make sure it is still water proof after plugging in the water and air pump plugs, and put the air stones inside the fish tank (Figure 46).

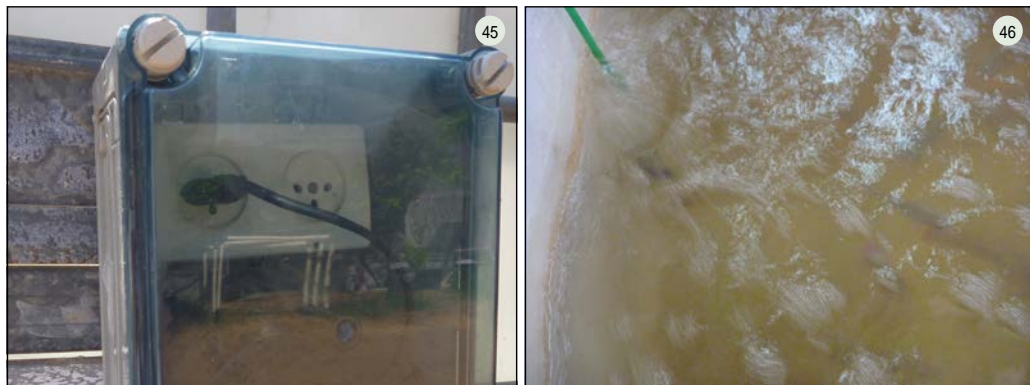

13. FINAL CHECKS

13.1 – All parts of the system are now in place. Before adding ammonia for cycling, fish or plants, fill the fish tank and both filters with water and run the pump to check for any leaks in the system. If leaks appear, fix them immediately (Figures 47–49). The following steps show this process.



Mechanical separator drainage check (Figures 50–52).



- Fill the biofilter with media and water (Figures 53a and 53b).
- Fill the mechanical separator with water (Figure 54).
- Mechanical separator and biofilter (Figure 55).

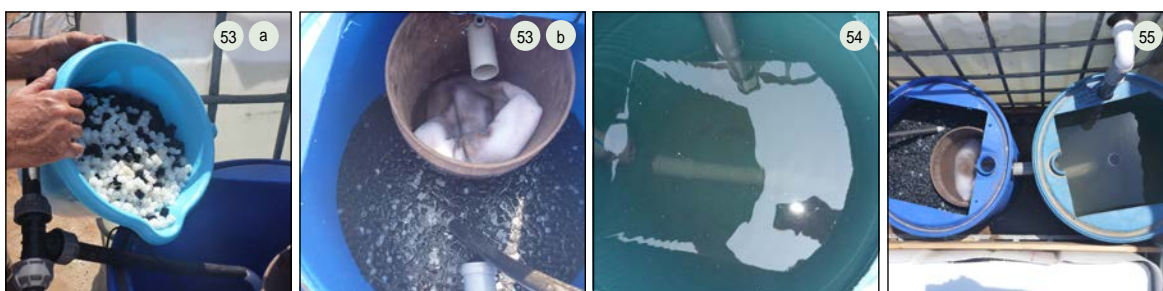

- Tighten the plumbing connections.
- Check all uniseals and taps for both filters.
- Re-apply Teflon to threaded connections.
- Make sure all valves are in their ideal position.

Finally, check the flow rate of the water flowing into each NFT pipe. The flow rate can be measured with a stopwatch and an empty 1 litre plastic bottle. A flow rate of 1–2 litres/minute, which is the standard in NFT pipes, should fill the bottle in 1 minute (1 litre/minute) or 30 seconds (2 litres/minute) (Figure 56).

Once all the leaks are fixed and the water is flowing smoothly through all components, it is possible to start cycling the unit using ammonia (see Chapter 5 of this publication for more details on this process).



14. PLANTING – MAKING THE PLANTING CUPS

14.1 – For planting, follow what is shown in the following figures. Make sure the plant cup has enough holes to allow the root system to grow out into the pipe but also to prevent the growing medium from falling out. A plant cup made from a net cup and 10 cm of PVC pipe (50 mm) (Figures 57–59).

A plant cup made from simple plastic/paper cups and a plastic bottle (Figures 60 and 61). Plant roots clearly visible (Figures 62–66).

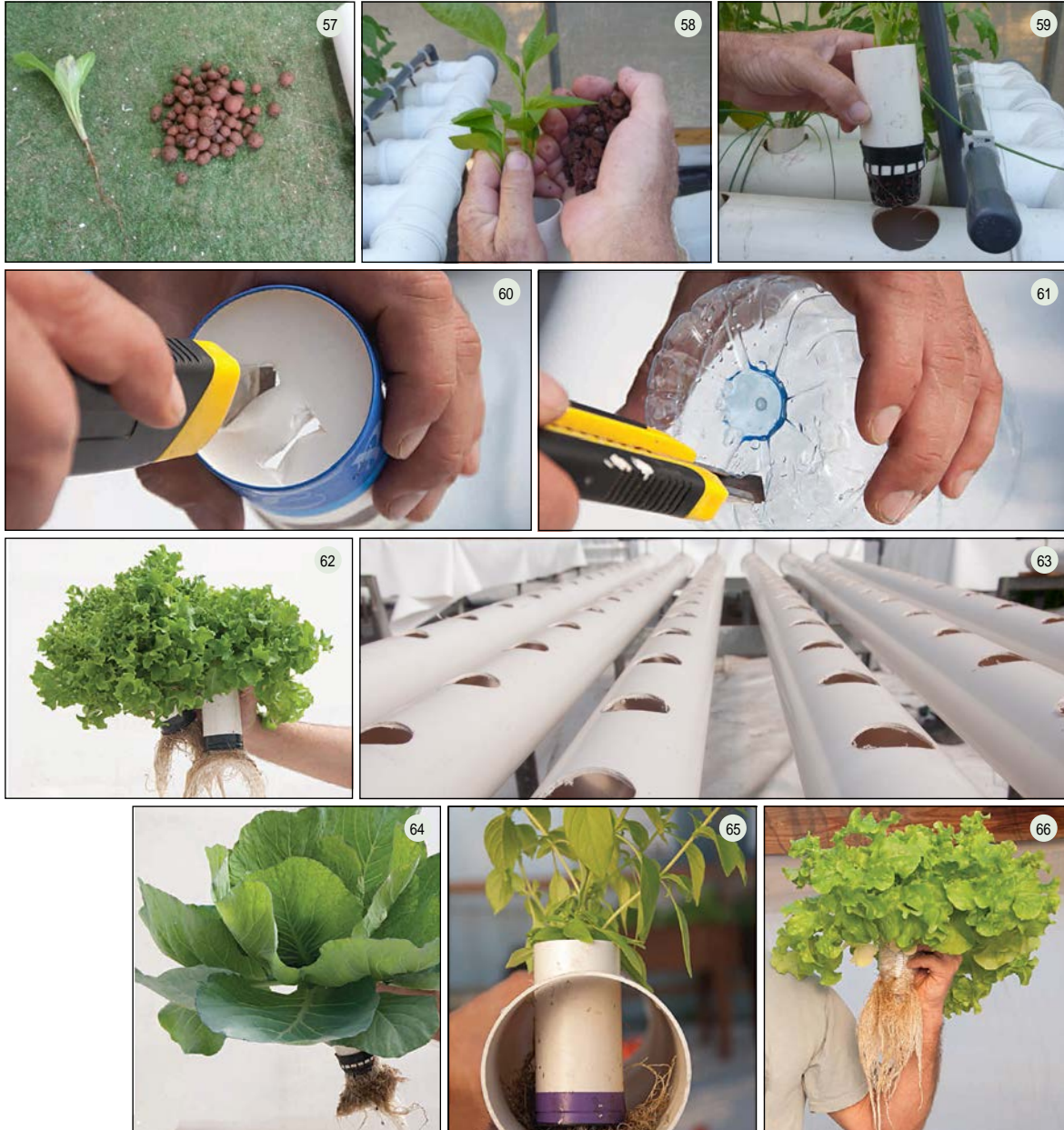

SECTION 3 – THE DEEP WATER CULTURE (DWC) UNIT

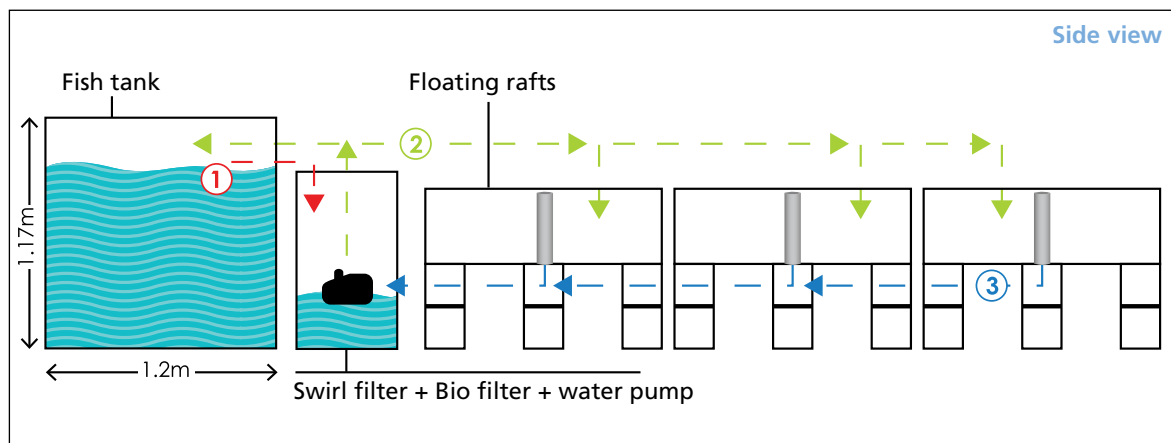
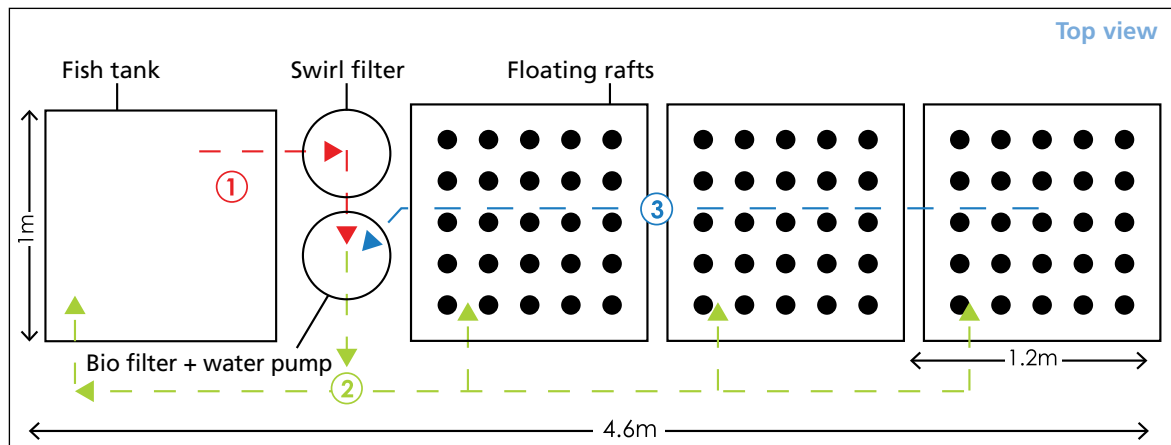
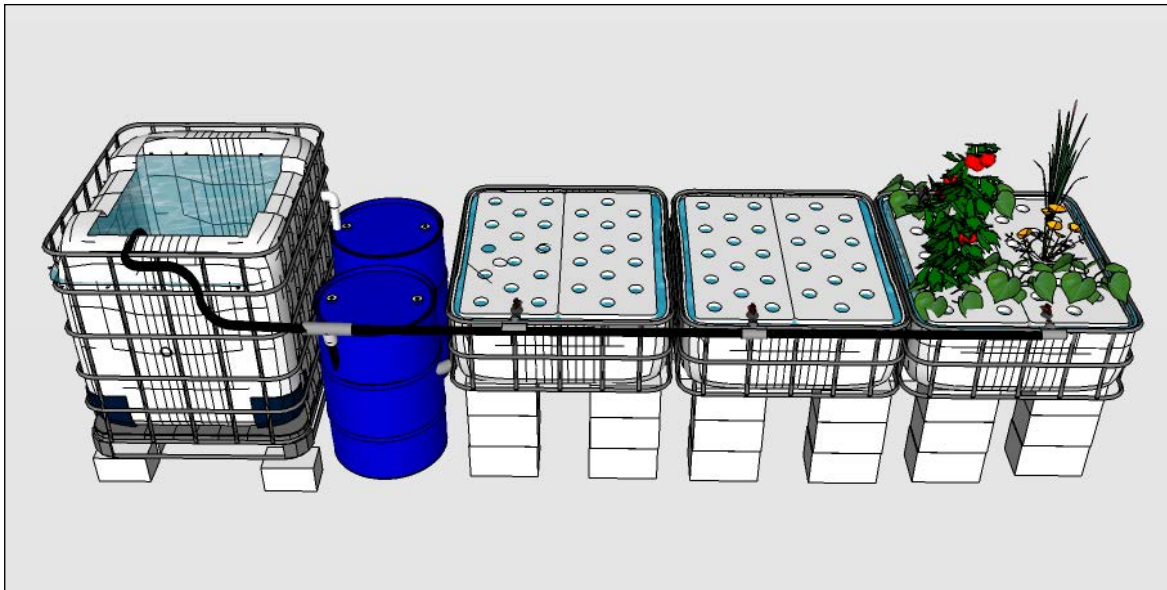

Water flow diagram

- ① Water flows by gravitation from the fish tank to the swirl filter and biofilter.
- ② Water is pumped, using the submersible pump, from the biofilter to the fish tank (80% of the flow) and the DWC canals (20% of the flow).
- ③ Water flows back from the canals to the biofilter.

TABLE A8.5
List of items for the DWC unit

	Item Name	Item No. from Table A8.1	Quantity
1	IBC tank	1	3
2	Bucket (20 litre)	28	1
3	200 litre barrel (blue)	2	2
4	Biofilter medium (Bioball® or bottle caps)	34	40–80 litres
5	Submersible water pump (min. 2 000 litres/h)	7	1
6	Air pump (10 watts/hour) with 4 exits*	29	1* (2)
7	Air tubing	30	10 m
8	Air stone	32	4
9	Concrete block	5	40
10	Lumber (8×1 cm)	6	8 m
11	Shade material	3	2 m ²
12	Fish net	33	1
13	Teflon (plumber's) tape	10	1
14	Cable tie	11	25
15	Electric box (waterproof)	12	1
16	Net pot	36	80
17	Gravel, volcanic (4–20 mm)	35	30 litres
18	Polystyrene sheet	9	3 m ²
19	Ecological soap or lubricant	8	1
PVC PIPES AND FITTINGS			
20	PVC or metal tap (¾ in) male to female	27	4
21	PVC or metal tap (1 in) male to female	47	1
22	PVC elbow (25 mm × ¾ in) male	24	3
23	PVC elbow (25 mm × ¾ in) female	49	1
24	PVC connector, T (25 mm × 1 in) female	53	2
25	PVC connector, T (25 mm × ¾ in) female	57	2
26	PVC elbow (25 mm × 1 in) female	23	2
27	PVC elbow (25 mm × ¾ in) female	49	1
28	PVC adaptor (25 mm × ¾ in)	52	1
29	PVC (25 mm × 1 in) female	21	3
30	PVC barrel connector, V-type (1 in)	46	5
31	Polyethylene pipe (25 mm)	17	8 m
32	PVC connector, T (25 mm × ¾ in) female	59	1
33	PVC pipe (25 mm)	16	0.9 m
34	PVC pipe (50 mm)	14	2 m
35	Uniseal® (50 mm)	18	5
36	PVC elbow (50 mm)	37	6
37	PVC coupler, straight (50 mm)	38	5
38	PVC endcap/stopper (50 mm)	40	1
39	Sealing rubber washer (50 mm)	19	10

1. **PREPARING THE FISH TANK (SAME AS MEDIA BED SECTIONS 1 AND 2).**
2. **PREPARING THE MECHANICAL SEPARATOR AND BIOFILTER (SAME AS NFT UNIT SECTIONS 1–4).**
3. **MAKING 3 DWC CANALS FROM 2 IBC TANKS (SAME AS MEDIA BED SECTION 4).**

4. INITIAL STEPS IN BUILDING A DWC SYSTEM

Follow the steps contained in the previous sections to set up the fish tank, the mechanical separator, the biofilter and 3 DWC canals from 2 IBCs. Once completed, proceed to assembling the DWC canals. For the DWC system, the cut IBC bed used as a sump tank in the media bed unit can be used as the 4th canal. Extra blocks and plumbing are required to install the 4th canal.

5. ASSEMBLING THE DWC CANALS

5.1 – Place the concrete blocks according to the distances described in Figure 1a. The fish tank should be raised up about 15 cm; do so by using concrete blocks. Then, place the three grow beds (including the metal support frames) on top of the blocks as shown in (Figure 1b) (Make sure the grow beds are secure on top of the blocks. If not, slightly adjust the layout of the blocks underneath).

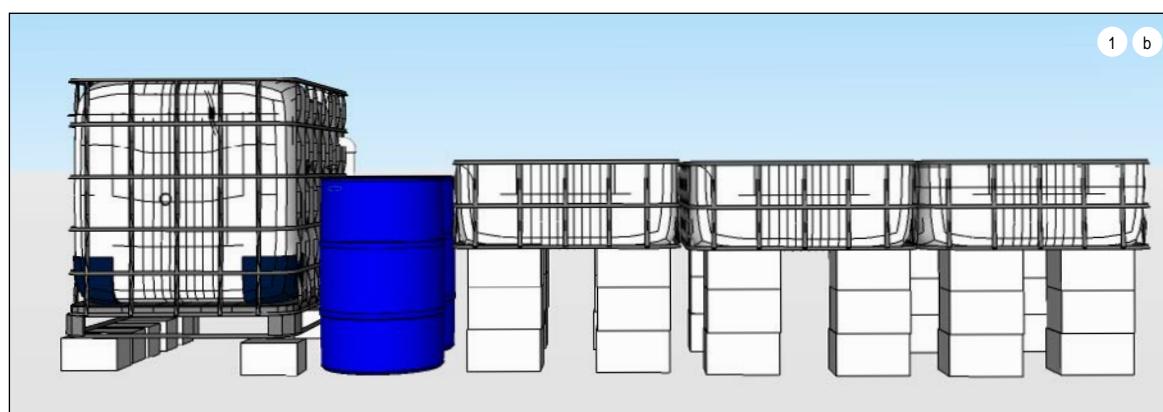
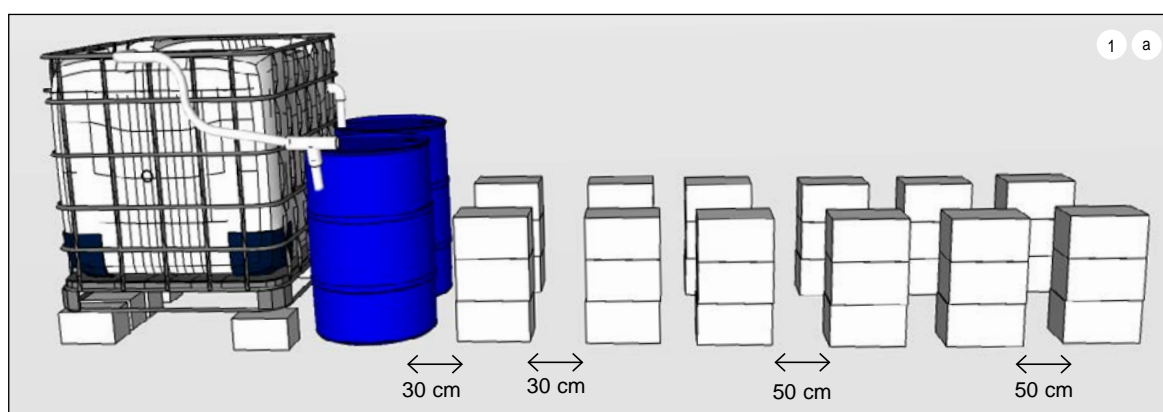

6. PREPARING THE DRAINAGE PIPES INTO THE BIOFILTER

The following materials are needed to make three drainage pipe units:

- 24 cm of PVC pipe (25 mm) × 3
- Barrel connectors (25 mm) × 3
- PVC adaptor, female (1 inch – 25 mm) × 3
- PVC elbow, female (1 inch – 25 mm) × 1

- PVC T-connector (25 mm – 1 inch [female] – 25 mm) × 2
- Rubber washer (25 mm) × 3

6.1 – Take each DWC canal and mark their centre points in the bottom of the canal. Drill a 25 mm diameter hole at each centre point and insert the 25 mm barrel connector (25 mm) with the rubber washer placed inside the grow bed. Tighten both sides of the connector using a wrench (see Figures 2–4).



6.2 – Screw the PVC adapter, female (1 inch – 25 mm) on to the barrel connector (25 mm) inside the tanks and then slot the standpipe into the adapter. Make sure to cut five longitudinal slots on the upper end of the standpipe to prevent the pipe from clogging (Figures 5–6).

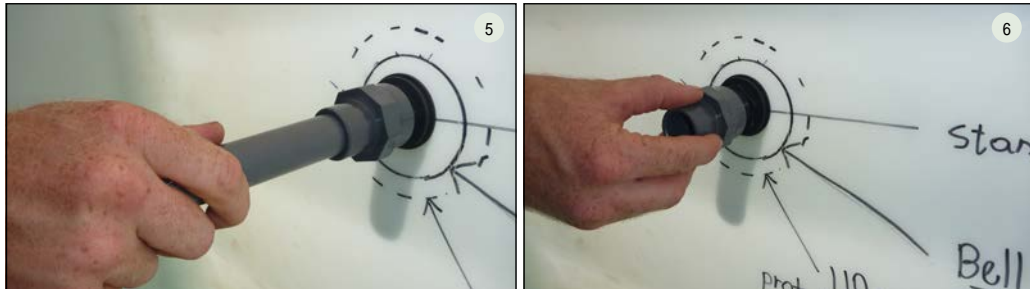

6.3 – Next, connect the PVC elbow, female (25 mm – 1 inch) to the end of the barrel connector underneath the DWC canal that is farthest from the fish tank (Figures 7–10). Then fix the remaining two PVC T connectors (25 mm – 1 inch [female] – 25 mm) to the barrel connectors underneath the other two canals. Take three pieces, each 1 m in length, of PVC pipe (25 mm) and connect the elbow to the two T-connectors underneath the canals (Figures 11 and 12).

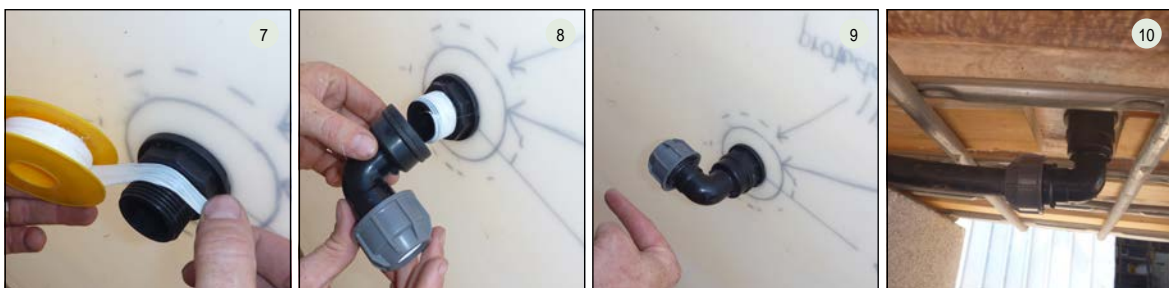

Connection between canals A, B and C



6.4 – Finally, drill a 25 mm hole into the side of the biofilter barrel using the circular drill bit at least 15 cm below the standpipe height in the canals and insert a barrel connector (1 inch) in it. Then, connect a PVC elbow (25 mm – 1 inch) to the barrel connector and then take one more piece of PVC pipe (25 mm) and connect the PVC elbow (25 mm – 1 inch) where it exits the biofilter to the final T-connector underneath the tank A and slot the other into the 25 mm hole in the biofilter (Figures 13 and 14).

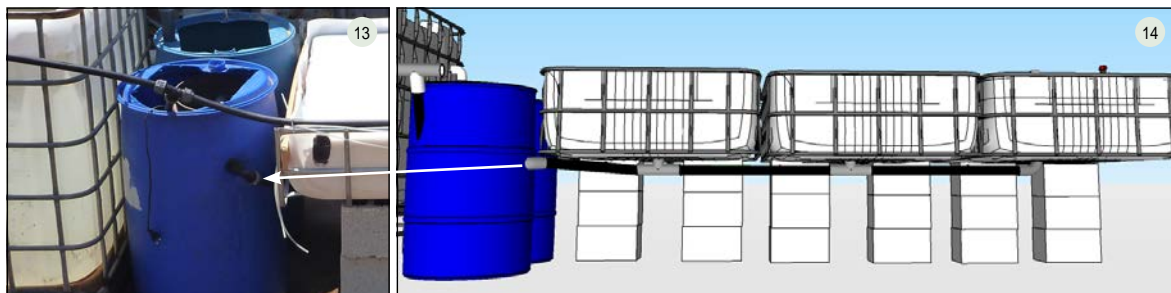

7. ADDING THE SUBMERSIBLE PUMP

For this unit, the submersible pump is placed at the bottom of the biofilter barrel (Figures 15 and 16).



Water is pumped from there into two locations: the 3 DWC canals and the fish tank. 80 percent of the water flows to the fish tank while 20 percent flows into the plant canals. The taps are used to control the water flow at each location (Figure 17).





8. PUMPING TO THE FISH TANK AND DWC CANALS

8.1 – Connect the submersible pump to a length of polyethylene pipe (25 mm) pipe length using an adaptor (1 inch female – 25 mm), or any other connection that fits to the pump. The pipe should be at least 1 m long. Place a T-connection (25 mm) at the end of the pipe allowing water to flow to the fish tank and the canals (Figure 18).



8.2 – Attach a pipe (25 mm) to one end of the T-connection long enough to reach the fish tank. Use flexible pipe if possible as this removes the need for elbow connections, which reduce the pumping capacity of the pump (Figure 19). Attach a tap (25 mm) to the end of the pipe to control the water flow into the fish tank.

8.3 – Next, take about 3.5 metres of polyethylene pipe (25 mm) and attach one end to the remaining exit of the T-connection (25 mm) coming from the pump in the biofilter. Then, take the 3.5 metre pipe and lay it along the DWC canals. At each canal, add a T-connector (25 mm – 3/4 inch – 25 mm), a tap (3/4 inch male – 3/4 inch female), and a PVC elbow (25 mm – 3/4 inch male) allowing water to flow into each canal at an angle (Figures 20–22). At the final canal furthest from the fish tank use a PVC elbow (25 mm – 3/4 inch female) instead of the T-connector. Be sure to secure the pipes to the metal frame by means of plastic cable ties.

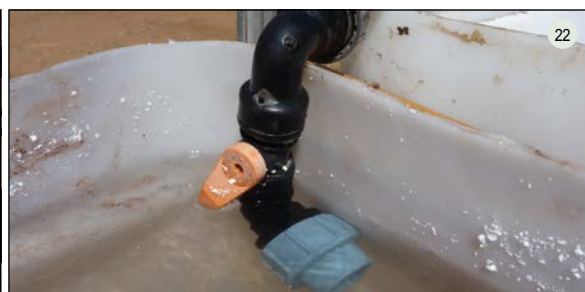

9. INSTALLING THE AIR PUMP AND STONES

9.1 – For this unit, the air pump is used to integrate air into the DWC canals. The air pump should be placed into a protected box at the highest point in the system (ideally attached to the side of the fish tank) (Figure 25). Take 4–6 m of 8 mm air pipe. Attach one end to the air pump and lay the rest of the 8 mm pipe along the side of all the DWC canals. On each tank, drill an 8 mm hole just below (1–2 cm) the top and slot the 8 mm pipe into each hole.

9.2 – Attach the air stones to the 8 mm pipe and place them next to the inlet water stream to ensure full oxygen saturation in the canal. Repeat the same air pipe connection for the fish tank (Figures 23, 24 and 26).



9.3 – Connect the pipes to the metal frame with plastic cable ties.

10. MAKING THE RAFTS

Key principles and rules of thumb for making the polystyrene rafts:

- All water in the canals should be fully covered (no exposure to light).
- Choose polystyrene sheets that are at least 3 cm thick to hold the weight of the vegetables.
- The polystyrene must not release any toxins to the water (make sure it is safe for food production or food-grade quality). Painted plywood can also be used.
- Plant hole sizes and spacing are dependent on the type of vegetables to be planted. The planting hole size can range from 16 mm (for planting seedlings directly into the rafts without cups [Figure 28]) to 30 mm. This depends on the size of net cups available (Figure 27).

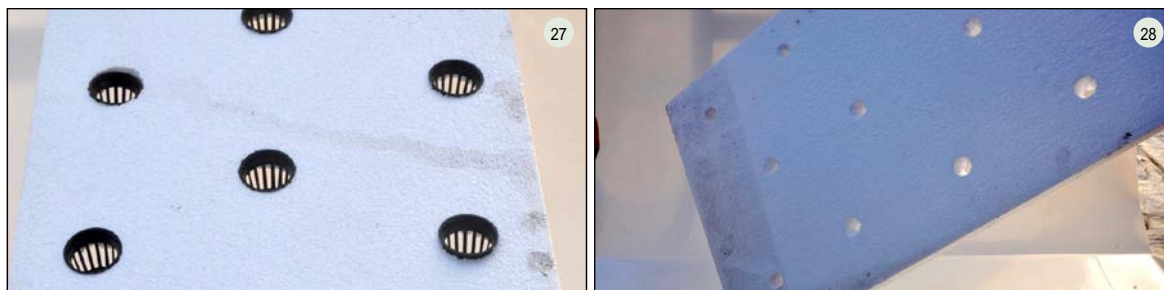

10.1 – Place the polystyrene on top of the DWC canals and mark the edge lines. With a knife, cut the outline of the canal (Figures 29–31).



10.2 – Drill the plant holes (Figures 34 and 35) using a circular drill bit (Figures 36 and 37). Along with planting holes, make sure to cut one hole for the standpipe of each canal (Figures 32 and 33).

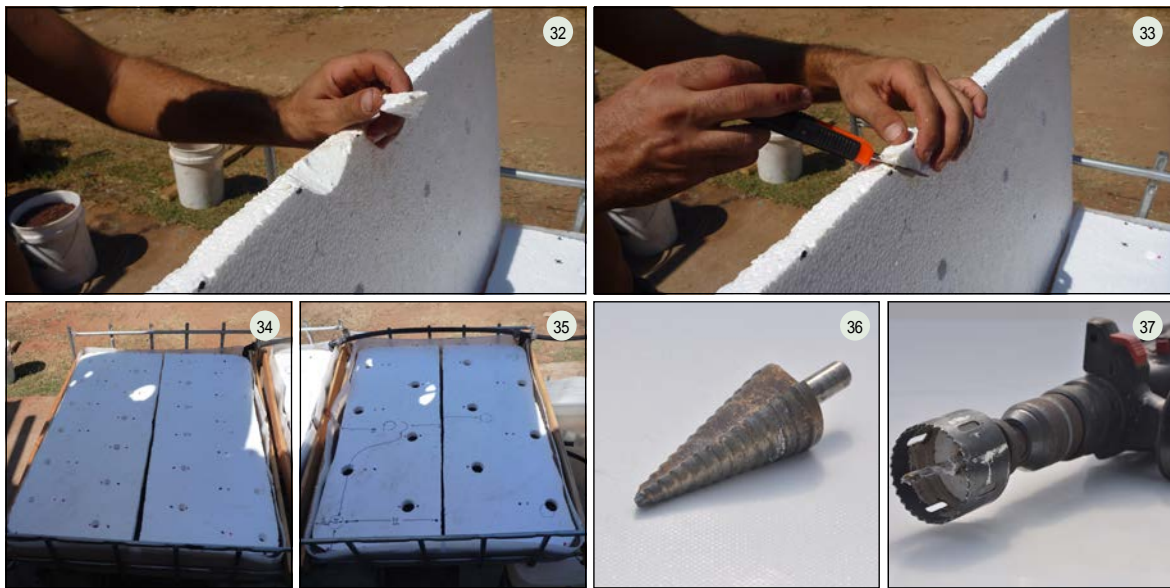

11. FINAL CHECKS

Once all parts of the system are in place, fill the fish tank, both filters and DWC canals (Figures 38–43) with water and run the pump to check for any leaks in the system. If leaks appear, fix them immediately where they arise by:

- Tightening the plumbing connections.
- Checking all uniseals and taps for both filters.
- Re-applying Teflon to threaded connections.
- Making sure all valves are in their ideal position.

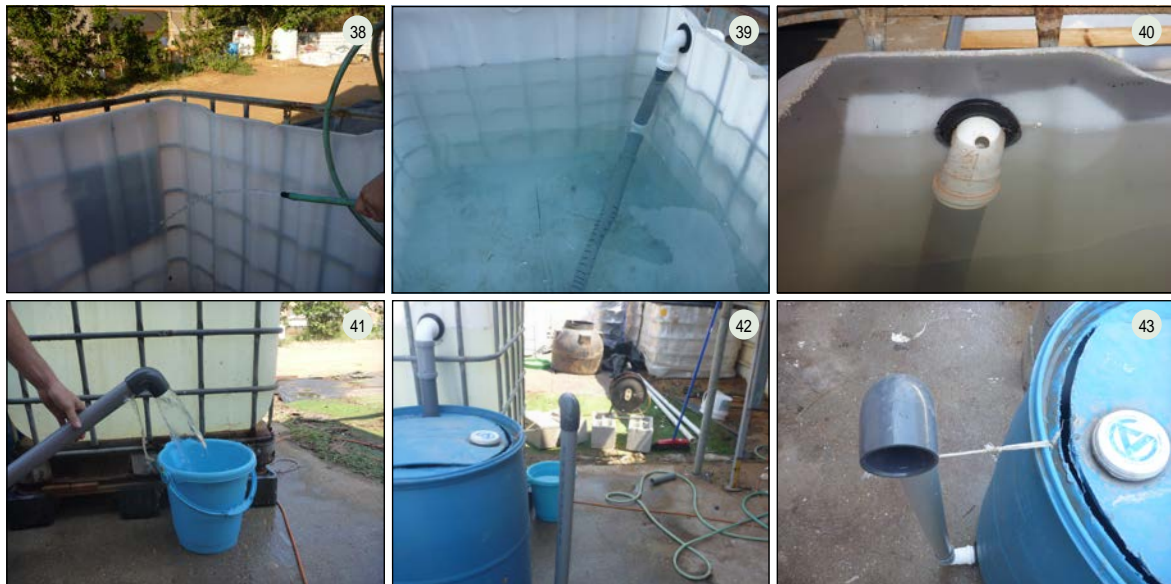

Secure all the remaining pipes with plastic cable ties (Figures 45–46).

Finally, check the flow rates of the water flowing into each DWC canal. Knowing that the volume of each canal is about 300 litres, the ideal flow rate for each canal should be 75–300 litres per hour according to the 1–4 hour residency time mentioned in Chapter 4 of this publication. Water inflow can be measured by using a stopwatch and an empty 1 litre plastic bottle (Figure 44) At 75 litres/hour the 1 litre bottle should fill up in 48 seconds, at 300 litres/hour in 12 seconds. Once all the leaks are fixed and the water

is flowing through all components of the unit, begin cycling the unit by using ammonia to stimulate nitrifying bacteria colonization (see Chapter 5 of this publication).



Planting process with cups (Figures 47–51) and without cups (Figure 52)



Finished system.



Aquaponics quick-reference handout

Note: The section below reproduces the chapter summaries from the FAO aquaponic publication (see citation below). It is intended to be a short and easy-to-reproduce supplement, envisioned for use in education, extension and outreach applications and is designed to be provided to students, workers and farmers.

The full technical paper can be found at: www.fao.org/publications/en/

Somerville, C., Cohen, M., Pantanella, E., Stankus, A. & Lovatelli, A. 2014. *Small-scale aquaponic food production. Integrated fish and plant farming*. FAO Fisheries and Aquaculture Technical Paper. No. 589. Rome, FAO. 262 pp.

INTRODUCTION TO AQUAPONICS

Aquaponics is the integration of recirculating aquaculture system (RAS) and hydroponics in one production system. In an aquaponic unit, water from the fish tank cycles through filters, plant grow beds and then back to the fish. In the filters the water is cleaned from the fish wastes by a mechanical filter that removes the solid part, and a biofilter that processes the dissolved wastes. The biofilter provides a location for bacteria to convert ammonia, which is toxic for fish, into nitrate, a more accessible nutrient for plants. This process is called nitrification. As the water (containing nitrate and other nutrients) travels through plant grow beds the plants uptake these nutrients, and finally the water returns to the fish tank purified. This process allows the fish, plants, and bacteria to thrive symbiotically and to work together to create a healthy growing environment for each other, provided that the system is properly balanced. Although the production of fish and vegetables is the most visible output of aquaponic units, it is essential to understand that aquaponics is the management of a complete ecosystem that includes three major groups of organisms: fish, plants and bacteria.

In aquaponics, the aquaculture effluent is diverted through plant beds and not released to the environment, while at the same time the nutrients for the plants are supplied from a sustainable, cost-effective and non-chemical source. This integration removes some of the unsustainable factors of running aquaculture and hydroponic systems independently. Beyond the benefits derived by this integration, aquaponics has shown that its plant and fish productions are comparable with hydroponics and RASs. Aquaponics can be much more productive and economically feasible in certain situations, especially where land and water are limited. However, aquaponics is complicated and requires substantial start-up costs. The increased production must compensate for the higher investment costs needed to integrate the two systems. Before committing to a large or expensive system, a full business plan considering economic, environmental, social and logistical aspects should be conducted.

AQUAPONIC UNIT DESIGN

- The main factors when deciding where to place a unit are: stability of ground; access to sunlight and shading; exposure to wind and rain; availability of utilities; and availability of a greenhouse or shading structure.
- There are three main types of aquaponics: the media bed method, also known as particulate bed; the nutrient film technique (NFT) method; and the deep water culture (DWC) method, also known as the raft method or floating system.
- The essential components for all aquaponic units are: the fish tank, the mechanical and biological filtration, the plant growing units (media beds, NFT pipes or DWC canals), and the water/air pumps.
- The media beds must: (i) be made of strong inert material; (ii) have a depth of about 30 cm; (iii) be filled with media containing a high surface area; (iv) provide adequate mechanical and biological filtration; (v) provide separate zones for different organisms to grow; and (vi) be sufficiently wetted through flood-and-drain or other irrigation techniques to ensure good filtration.
- For NFT and DWC units, mechanical and biofiltration components are necessary in order to respectively remove the suspended solids and oxidize the dissolved wastes (ammonia to nitrate).
- For NFT units, the flow rate for each grow pipe should be 1–2 litres/minute to ensure good plant growth.
- For DWC units each canal should have a retention time of 1–4 hours.
- High DO concentration is essential to secure good fish, plant and bacteria growth. In the fish tank DO is supplied by means of air stones. Media bed units have an interface between the wet zone and dry zone that provides a high availability of atmospheric oxygen. In NFT units, additional aeration is provided into the biofilter, while in DWC air stones are positioned in the biofilter and plant canals.

NOTES:

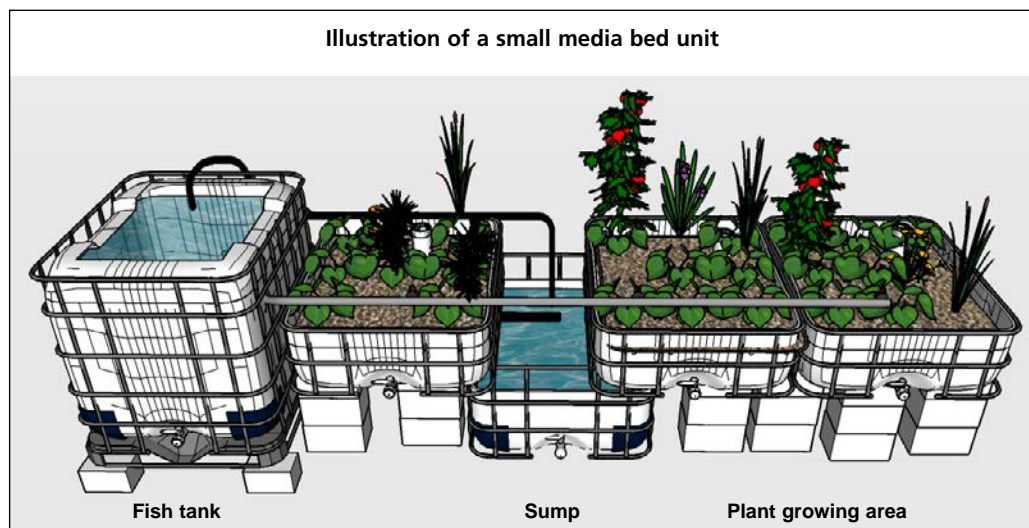

BALANCING THE FISH AND PLANTS: COMPONENT CALCULATIONS

Aquaponic systems need to be balanced. The fish (and thus, fish feed) need to supply adequate nutrients to the plants; the number of plants should be adequate to use all the nutrients released, but not in excess to prevent any risk of deficiencies. The biofilter needs to be large enough to process all of the fish wastes, and enough water volume is needed to circulate this system. This balance can be tricky to achieve in a new system, but this section provides helpful calculations to estimate the sizes of each of the components.

The most successful way to balance an aquaponic system is to use the feed rate ratio described in Section 2.1.4 of this publication. This ratio is the most important calculation for aquaponics so that the fish and plants can thrive symbiotically within the aquaponic ecosystem.

The ratio estimates how much fish feed should be added each day to the system, and it is calculated based on the area available for plant growth. This ratio depends on the type of plant being grown; fruiting vegetables require about one-third more nutrients than leafy greens to support flowers and fruit development. The type of feed also influences the feed rate ratio, and all calculations provided here assume an industry standard fish feed with 32 percent protein. Lower-protein feeds can be fed at higher rates.

Leafy green plants	Fruiting vegetables
40–50 g of fish feed per square metre	50–80 g of fish feed per square metre

The recommended first step in the calculation is to determine how many plants are needed. Plants are most likely the most profitable part in small-scale aquaponics because of the high turnover rate. On average, plants can be grown at the following planting density. These figures are only averages, and many variables exist depending on plant type and harvest size, and therefore should only be used as guidelines.

Leafy green plants	Fruiting vegetables
20–25 plants per square metre	4 plants per square metre

Choose the amount of growing area needed using the above metric (leafy vs. fruiting). The surface area needs to be chosen by the farmer to meet market or food production targets. This also depends on the crop, because some plants require more space and grow more slowly than others. Once the desired number of plants has been chosen, it is then possible to determine the amount of growing area needed and, consequently, the amount of fish feed that should be added to the system every day.

Once the amount of fish feed has been calculated, it is possible to determine the biomass of the fish needed to eat this fish feed. Different-sized fish have different feed requirements and regimes, this means that many small fish eat as much as a few large fish. In terms of balancing an aquaponic unit, the actual number of fish is not as important as the total biomass of fish in the tank. On average, the fish will consume 1–2 percent of their body weight per day during the grow-out stage, which correspond to a body mass above 50g. On the contrary small/young fish eat more than large ones, as a percentage of body weight.

Fish feeding rate
1–2 % of total body weight per day

The following example demonstrates how to conduct this set of calculations: In order to produce 25 heads of lettuce per week, an aquaponic system should have 10–20 kg of fish, fed 200 grams of feed per day, and have a growing area of 4 m². The calculations are as follows:

Lettuce requires 4 weeks to grow once the seedlings are transplanted into the system, and 25 heads per week are harvested, therefore:

$$25 \text{ heads/week} \times 4 \text{ weeks} = 100 \text{ heads in system}$$

Each 25 heads of lettuce require 1 m² of growing space, therefore:

$$100 \text{ heads} \times \frac{1 \text{ m}^2}{25 \text{ heads}} = 4 \text{ m}^2$$

Each square metre of growing space requires 50 g of fish feed per day, therefore:

$$4 \text{ m}^2 \times \frac{50 \text{ grams feed/day}}{1 \text{ m}^2} = 200 \text{ grams feed/day}$$

The fish (biomass) in a system eats 1–2 percent of their body weight per day, therefore:

$$200 \text{ grams feed/day} \times \frac{100 \text{ grams fish}}{1-2 \text{ grams feed/day}} = 10-20 \text{ kg of fish biomass}$$

Although extremely helpful, this feed ratio is really only a guide, particularly for small-scale units. There are many variables involved with this ratio, including the size and type of fish, water temperature, protein content of the feed, and nutrient demands of the plants, which may change significantly over a growing season. These changes may require the farmer to adjust the feeding rate. Testing the water for nitrogen helps to determine if the system remains in balance. If nitrate levels are too low (less than 5 mg/litre), then slowly increase the feed rate per day without overfeeding the fish. If the nitrate levels are stable, then there may be deficiencies in other nutrients and supplementation may be required especially for calcium, potassium and iron. If nitrate levels are increasing then occasional water exchanges will be necessary as nitrate rises above 150 mg/litre. Increasing nitrate levels suggest that the concentration of other essential nutrients is adequate.

Practical system design guide for small-scale aquaponic units

Fish tank volume (litre)	Max. fish biomass ¹ (Kg)	Feed rate ² (g/day)	Pump flow rate (litre/h)	Filters volume ³ (litre)	Min. volume of biofilter media ⁴ (litre)		Plant growing area ⁵ (m ²)
					Volcanic tuff	Bioballs®	
200	5	50	800	20	50	25	1
500	10	100	1 200	20–50	100	50	2
1 000	20	200	2 000	100–200	200	100	4
1 500	30	300	2 500	200–300	300	150	6
2 000	40	400	3 200	300–400	400	200	8
3 000	60	600	4 500	400–500	600	300	12

Notes:

- ¹ The recommended fish density is based on a maximum stocking density of 20 kg/1 000 litres. Higher densities are possible with further aeration and mechanical filtration, but this is not recommended for beginners.
- ² The recommended feeding rate is 1 percent of body weight per day for fish of more than 100 g of body mass. The feeding rate ratio is: 40–50 g/m² for leafy greens; and 50–80 g/m² for fruiting vegetables.
- ³ The volumes for mechanical separator and biofilter should be 10–30 percent of total fish tank volume. In reality, the choice of containers depends on their size, cost and availability. Biofilters are only needed for NFT and DWC units; mechanical separators are applicable for NFT, DWC units and media bed units with a fish density of more than 20 kg/1 000 litres.
- ⁴ These figures assume the bacteria are in optimal conditions all the time. If not, for a certain period (winter), extra filtration media may need to be added as a buffer. Different values are provided for the two most common biofilter media based on their respective specific surface area.
- ⁵ Figures for plant growing space include only leafy greens. Fruiting vegetables would have a slightly lower area.

Aquaponics is a symbiotic integration of two mature disciplines – aquaculture and hydroponics. This technical paper discusses the three groups of living organisms (bacteria, plants and fish) that make up the aquaponic ecosystem. It presents management strategies and troubleshooting practices, as well as related topics, specifically highlighting the advantages and disadvantages of this method of food production.

This publication discusses the main theoretical concepts of aquaponics, including the nitrogen cycle, the role of bacteria, and the concept of balancing an aquaponic unit. It considers water quality, testing and sourcing for aquaponics, as well as methods and theories of unit design, including the three main methods of aquaponic systems: media beds, nutrient film technique, and deep water culture.

The publication includes other key topics: ideal conditions for common plants grown in aquaponics; chemical and biological controls of common pests and diseases including a compatible planting guide; common fish diseases and related symptoms, causes and remedies; tools to calculate the ammonia produced and biofiltration media required for a certain amount of fish feed; production of homemade fish food; guidelines and considerations for establishing aquaponic units; a cost–benefit analysis of a small-scale, media bed aquaponic unit; a comprehensive guide to building small-scale versions of each of the three aquaponic methods; and a brief summary of this publication designed as a supplemental handout for outreach, extension and education.

Aquaponics is an integrated approach to efficient and sustainable intensification of agriculture that meets the needs of water scarcity initiatives. Globally, improved agricultural practices are needed to alleviate rural poverty and enhance food security.

Aquaponics is residue-free, and avoids the use of chemical fertilizers and pesticides. Aquaponics is a labour-saving technique, and can be inclusive of many gender and age categories. In the face of population growth, climate change and dwindling supplies of water and arable land worldwide, developing efficient and integrated agriculture techniques will support economic development.

